

BEFORE THE ILLINOIS POLLUTION CONTROL BOARD

IN THE MATTER OF: )  
 ) AS 2021-002  
PETITION OF MIDWEST )  
GENERATION, LLC FOR AN )  
ADJUSTED STANDARD FROM 35 ILL. )  
ADMIN. CODE PARTS 811 AND 814 )

**NOTICE OF FILING**

To: See attached Service List

PLEASE TAKE NOTICE that I have today electronically filed with the Office of the Clerk of the Pollution Control Board Midwest Generation, LLC's Response to the Illinois Environmental Protection Agency's Recommendations, a copy of which is herewith served upon you.

Dated: March 24, 2022

MIDWEST GENERATION, LLC

By:     /s/Kristen L. Gale    

Kristen L. Gale  
Susan M. Franzetti  
Molly Snittjer  
NIJMAN FRANZETTI LLP  
10 South LaSalle Street Suite 3600  
Chicago, IL 60603  
(312) 251-5590  
[kg@nijmanfranzetti.com](mailto:kg@nijmanfranzetti.com)  
[sf@nijmanfranzetti.com](mailto:sf@nijmanfranzetti.com)  
[ms@nijmanfranzetti.com](mailto:ms@nijmanfranzetti.com)

**SERVICE LIST**

Don Brown, Clerk of the Board  
Illinois Pollution Control Board  
James R. Thompson Center, Suite 11-500  
100 W. Randolph Street  
Chicago, IL 60601  
[don.brown@illinois.gov](mailto:don.brown@illinois.gov)

Bradley P. Halloran, Hearing Officer  
Illinois Pollution Control Board  
100 West Randolph Street  
Suite 11-500  
Chicago, IL 60601  
[Brad.Halloran@illinois.gov](mailto:Brad.Halloran@illinois.gov)

Christine Zeivel  
Stefanie Diers  
Division of Legal Counsel  
Illinois Environmental Protection  
Agency 1021 North Grand Avenue East  
P.O. Box 19276  
Springfield, IL 62794-9276  
[Christine.Zeivel@illinois.gov](mailto:Christine.Zeivel@illinois.gov)  
[Stefanie.Diers@illinois.gov](mailto:Stefanie.Diers@illinois.gov)

**CERTIFICATE OF SERVICE**

The undersigned, an attorney, certifies that a true copy of the foregoing Notice of Filing, and Midwest Generation, LLC's Response to the Illinois Environmental Protection Agency's Recommendations was electronically filed on March 24, 2022 with the following:

Don Brown, Clerk of the Board  
Illinois Pollution Control Board  
James R. Thompson Center, Suite 11-500  
100 W. Randolph Street  
Chicago, IL 60601  
[don.brown@illinois.gov](mailto:don.brown@illinois.gov)

and that copies were sent via e-mail on March 24, 2022 to the parties on the service list.

Dated: March 24, 2022

/s/Kristen L. Gale

Kristen L Gale  
Susan M. Franzetti  
Molly H. Snittjer  
Nijman Franzetti LLP  
10 S. LaSalle Street, Suite 3600  
Chicago, IL 60603  
(312) 251-5590  
[kg@nijmanfranzetti.com](mailto:kg@nijmanfranzetti.com)  
[sf@nijmanfranzetti.com](mailto:sf@nijmanfranzetti.com)  
[ms@nijmanfranzetti.com](mailto:ms@nijmanfranzetti.com)

**BEFORE THE ILLINOIS POLLUTION CONTROL BOARD**

**IN THE MATTER OF:** )  
 )  
**Petition of Midwest Generation** )  
**for an Adjusted Standard from 845.740(a)** )  
**and Finding of Inapplicability of Part 845** ) **AS 2021-001**  
**(Joliet 29)** )  
 )  
 )  
 )

**MIDWEST GENERATION LLC’S RESPONSE TO THE ILLINOIS ENVIRONMENTAL PROTECTION AGENCY’S RECOMMENDATION**

The Illinois Environmental Protection Agency’s (“Illinois EPA” or “Agency”) Recommendation wrongly assumes that there is coal combustion residual (“CCR”) under and around the HDPE liner at Pond 2 at the Midwest Generation LLC (“MWG”) Joliet 29 Station. The facts and data do not support that assumption. Over ten years of groundwater monitoring results relating to Pond 2 show there is no groundwater contamination from CCR, which would certainly not be the case after all these years if the Agency’s speculation about the presence of CCR under and around Pond 2 was credible. The primary indicators of CCR releases, including boron and barium, have never been detected above the groundwater protection standards at the monitoring wells surrounding Pond 2. The only two constituents found above the standards are chloride and cobalt. The Illinois EPA agrees that the chlorides are caused by road salt applications on the adjacent U.S. Highway 6. And the cobalt in the groundwater is also caused by road salt because chlorides from the road salt mobilize metals like cobalt in soil, resulting in a release of cobalt to groundwater.

There is also no evidence of that CCR was placed under or used for the construction of Pond 2. The construction drawings, invoices, and field notes from MWG’s relining of Pond 2 do not identify any use of CCR as fill. To the contrary, these documents confirm that CCR was removed.



None of the boring logs surrounding the pond show CCR, and the companies that logged the borings have confirmed that had the presence of CCR been observed in the borings, they would have identified it in the logs.

Finally, the Agency's theory that the poz-o-pac liner contains CCR and hence, must be removed is also incorrect. While poz-o-pac contains fly ash and boiler slag, it is made by a pozzolanic reaction which transforms the fly ash and encapsulates the boiler slag. Poz-o-pac is not CCR as defined under the Illinois Environmental Protection Act ("Act").

There is no evidence either that CCR is present in or below Pond 2 or that of the groundwater around Pond 2 is contaminated from CCR. MWG's requested adjusted standard to reuse its protective HDPE liner should be granted because it will not "result in environmental or health effects substantially or significantly more adverse than those considered by the Board in adopting the generally applicable effluent standard." 35 Ill. Adm. Code 104.426; 415 ILCS 5/28.1 (c)).

**I. Groundwater Data Demonstrates That Pond 2 and the Material Below Pond 2 Are Not CCR**

The absence of any exceedances of the Illinois groundwater protection standards ("GWPS") in 35 Ill. Adm. 845.600 for leading indicators of CCR constituents in Pond 2 wells shows there is no threat of groundwater contamination from Pond 2 and supports the conclusion that there is no CCR under the pond. The Agency's unsupported contention that elevated cobalt in the groundwater is due to CCR releases is refuted by expert opinion that the cobalt concentrations are instead due to the chlorides from the road salt activating the cobalt in soil.

**a. No Primary CCR Constituents are Present in Groundwater at Pond 2.**

The leading indicators of CCR releases are boron, calcium, fluoride, pH, sulfate, and total dissolved solids ("TDS") (the "Appendix III constituents"). Weaver Consulting Group ("WCG")

March Rpt., p. 7, attached as Ex. 22;<sup>1</sup> 80 Fed. Reg. 21342). MWG has sampled Joliet 29's groundwater for over 10 years,<sup>2</sup> and the leading indicator constituents of CCR have never been reported at concentrations exceeding the GWPS in the wells surrounding Pond 2. Ex. 22, p. 7. If Pond 2 had contained or was in some way constructed with CCR as the Agency speculates, a release of CCR from Pond 2 to groundwater would have been detected by now in the years of groundwater monitoring data.

It is indisputable that the type of CCR produced by the Joliet 29 Station operations contains boron - - the primary indicator constituent of CCR. Joliet 29 Station CCR, including CCR historically managed at Pond 2, has been landfilled for years in the Lincoln Stone Quarry ("LSQ"), an Illinois EPA permitted landfill. Data analyzing the CCR placed in LSQ confirms that boron is a primary indicator constituent for the CCR produced from the Joliet 29 station. Ex. 22, p. 8-9. At the LSQ, boron is consistently present in monitoring wells and exhibits statistically significant increases in the CCR groundwater monitoring network. *Id.*, p. 8. Besides the groundwater data, the analytical results of quarterly leachate samples from a piezometer in the LSQ in 2012 show boron concentrations consistently above the Part 845 GWPS for all four quarters. *Id.*, p. 9. Arsenic and barium, both of which are CCR indicators, were also consistently detected in the leachate samples. *Id.* The absence of boron, arsenic, and barium in the groundwater around Pond 2 above the GWPS compared to the presence of the same metals in CCR from Joliet 29 demonstrates that groundwater at Pond 2 is not being affected by CCR. *Id.* The Agency does not address, let alone

---

<sup>1</sup> To reduce confusion, MWG has continued the sequentially numbering of its Petition exhibits. Additionally, all of the Agency's Recommendation exhibits referenced in this response are provided in an index chart with page numbers.

<sup>2</sup> This includes groundwater monitoring pursuant to the 2010 CCA, groundwater monitoring performed at Joliet 29 Station in accordance with the Federal CCR rule (40 CFR Part 257), and as of 2021, groundwater monitoring performed in accordance with the Illinois CCR Rule (35 Ill. Adm. Code Part 845). *See* Rec. Ex. G, Attachment 5 (WCG Dec. 6, 2021 Report); Ex. 23 Affidavit of Richard Gnat, ¶¶ 4,5.

explain, how if CCR were present in or under Pond 2, boron would not be detected above the GWPS in the groundwater monitoring wells around Pond 2.

As MWG's expert witness Michael Maxwell finds, the absence of boron detections in the groundwater above GWPS is particularly persuasive evidence that a CCR release from Pond 2 has not occurred. Mr. Maxwell states in his expert opinion report that "[i]n my professional career comprising over 25 years of experience involving groundwater monitoring programs at CCR facilities, boron is by far the most common constituent identified in groundwater in documented cases where CCR has impacted groundwater. The absence of boron in the groundwater around Pond 2 at concentrations exceeding the GWPS is the single most important factor in an evaluation of whether data from monitoring well MW-4 is indicative of impacts related to CCR." Ex. 22, p. 8 (emphasis added). The absence of other known CCR constituents above the GWPS in the wells around Pond 2 further supports Mr. Maxwell's expert opinion that CCR is not present. *Id.*

**b. Isolated Cobalt Detections Are Not Indicative of CCR.**

Cobalt is a well-documented naturally occurring constituent in background soils in Illinois, and specifically in soils in Will County. *See* Ex. 22, p. 9-10. Cobalt is not a primary indicator constituent of CCR. *Id.*, p. 7. Yet, because none of the leading indicators of CCR are present above GWPS in the Pond 2 groundwater monitoring wells, the Agency attempts to tie the limited presence of cobalt at levels above the GWPS to a CCR release from Pond 2. The Agency resorts to this argument because besides cobalt, the only groundwater constituent that exceeds the GWPS is chloride, and even the Agency agrees that the elevated chloride levels are attributable to road salt applied to nearby U.S. Highway 6. *See* Rec., p. 21, 24; Rec. Ex. A, ¶ 34 (citing Rec. Ex. M).

Moreover, because there is scarce evidence that elevated cobalt levels are present in the groundwater around Pond 2, the Agency misleadingly equates the mere "detection" of cobalt to

exceedances of the GWPS. The actual facts are that since 2015, cobalt has only been detected at concentrations above the GWPS at one of the three Pond 2 downgradient wells, MW-4. Ex. 22, p. 9. The Agency's vague reference to "detections" of cobalt at the other two downgradient wells, MW-3 and MW-5, refers to *any detection above the laboratory's minimum detection limit* ("MDL"). See Rec., p. 22 n. 17. The MDL for cobalt is extremely low, 0.001 ppm, and the detections the Agency references range from 0.0011 to 0.0014 ppm. Rec. Ex. O, tbl. 1. These detections are only just above the MDL and well below the GWPS of 0.006 ppm. They are not evidence of CCR in Pond 2. *Id.*

If CCR material were the source of the cobalt detected in the groundwater at MW-4, the overall groundwater quality signature at MW-4 would be more indicative of CCR. Ex. 22, p. 9. Instead, there is a glaring absence of any exceedance of the other CCR indicators alongside cobalt—not even one other constituent commonly attributed to CCR even occasionally exceeds the GWPS at MW-4. *Id.* This includes the less common metal constituents that may be associated with CCR: antimony, arsenic, barium, beryllium, cadmium, chromium, lead, lithium, mercury, molybdenum, selenium, and thallium. *Id.*, p. 8 (citing 35 Ill. Adm. Code 845.600 metals). The groundwater monitoring data reveals that "[n]one of these metals have been detected in the groundwater at Pond 2 at concentrations exceeding the GWPS during the historical groundwater monitoring program, which dates back over 10 years to the 4th quarter of 2010." *Id.* The isolated detections of cobalt above the GWPS, with no other metals more commonly associated with CCR detected above the GWPS, demonstrates that the source of the cobalt is not CCR.

**c. Cobalt Exceedances in MW-4 Are Due to Road Salt Application, not CCR.**

As noted above, cobalt naturally occurs in Will County soils. Therefore, it is understandable that cobalt is detected in the groundwater at Joliet 29. Mr. Maxwell's expert opinion shows that

the cobalt in the groundwater is due to the elevated chlorides from the road salt, which mobilizes the naturally occurring cobalt in the soil and releases it to groundwater.

Illinois regulations and studies clearly show that cobalt is in Illinois soils. The Illinois Tiered Approach to Corrective Action Objectives (“TACO”) regulation has a background soils concentration for cobalt at 8.9 mg/kg in Counties Within Metropolitan Statistical Areas, which includes Will County. Ex. 22, p. 9 (citing 35 Ill. Adm. Code 742, Appx. A, Tbl. G). Similarly, a statewide study shows that cobalt is detected above laboratory reporting limits throughout the state. *Id.*, p. 10. Concentrations of cobalt in Will County soils ranged from 6.9 mg/kg to 10.9 mg/kg. *Id.*

Naturally occurring cobalt in soils can be mobilized into the groundwater by the chlorides in road salt. *Id.*, p. 11. According to a study called relied upon by Mr. Maxwell called “A Review of the Combined Threats of Road Salts and Heavy Metals to Freshwater Systems,” heavy metals in roadside soils are usually bound within the organic soils. *Id.* However, the metals can be mobilized by road salts including sodium chloride (a/k/a “rock salt”), magnesium chloride, and calcium chloride. *Id.*, p. 11.<sup>3</sup> Roadway salt application releases heavy metals through several interrelated mechanisms, and road salts increase the distribution of heavy metals by disrupting soil structure, changing soil chemistry, and altering ion exchange. *Id.*, p. 11-12. Thus, here, Mr. Maxwell concludes that the cobalt naturally in Will County soils is being mobilized by the road salts applied to U.S. Highway 6. *Id.*, p. 12 The mobilized cobalt leaches into the groundwater, where it migrates toward the Pond 2 monitoring wells. *Id.*

---

<sup>3</sup> The City of Joliet uses rock salt on its roads. See City of Joliet, Legislative Text, Award of Contract for the Rock Salt Purchase 2021-2022, <https://www.joliet.gov/Home/Components/RFP/RFP/4342/> (Recommendation to purchase 10,000 tons of rock salt).

**d. The Absence of a Statistically Significant Increase in Trends in the Groundwater Shows There is No CCR in Pond 2.**

There are also no statistically significant trends of the CCR constituent groundwater detections (which are already below GWPS) that would indicate there is CCR present in Pond 2 that is leaching into groundwater. Mr. Maxwell conducted a statistical trend analysis of the Appendix III constituents for the Joliet 29 monitoring wells to evaluate changes in groundwater constituent concentrations. Rec. Ex. G Attachment 5, p. 3. In the over 132 trend tests he performed, groundwater monitoring data from monitoring wells at Joliet 29, including Pond 2 wells, exhibited no statistically significant increases for the Appendix III constituents. *Id.*, p. 6. Citing Mr. Maxwell's statistical trend analysis, MWG's expert Thomas Dehlin stated that if CCR was present under Pond 2's liner, "it would be expected that the concentrations of Appendix III groundwater monitoring constituents would be consistently measured above their respective statistically-derived prediction limit." Rec. Ex. G, p. 4 (citing Attachment 5). However, the groundwater data collected at Joliet 29 and from Pond 2 monitoring wells show that this is not happening.

**e. The Agency's Interpretation of the Stormwater Flow is Incorrect and Not Indicative of CCR in the Pond 2 Embankments.**

The Agency's description of the transport mechanisms exhibited by chloride-impacted stormwater from road salts on U.S. Highway 6 ("highway"),<sup>4</sup> is fundamentally flawed and incorrect. The Agency appears to state that stormwater from the highway flows over the land from the highway right-of-way, up the two foot ditch embankment, onto the Joliet 29 property and continues over land to the Pond 2 embankment where it could percolate through the upper soils next to the pond within a week. Ex. 22., p. 5-6. The Agency's description of the stormwater flow

---

<sup>4</sup> Illinois EPA and MWG agree that the chloride exceedances are due to road salts applied to U.S. Highway 6 north of Pond 2. *See* Rec. p. 21, 24 and Rec. Ex. A ¶34 (both citing Rec. Ex. M).

defies gravity. Because the stormwater flow path the Agency describes is impossible, the Agency's resulting conclusions that the soil surrounding the pond has high hydraulic conductivity, which in turn indicates that the soil is CCR, has no basis.

The surface topography along U.S. Highway 6 is contoured to collect stormwater in an earthen ditch along the south side of the highway (between the highway and MWG property). Ex. 22, p. 5. The ditch, shown on Exhibit B to Mr. Maxwell's report, is approximately two feet deep and prevents stormwater from flowing over land to the immediate vicinity of the Pond 2 embankment, as the Agency contends. *Id.*, p. 6 and Exhibit B. Stormwater flows from the highway to the shoulder of the road and into the drainage ditch. *Id.* Some of the stormwater flows down the ditch gradient to the east, and gravity causes the other portion of the storm water to percolate vertically through the soil in the ditch, encountering the groundwater close to the highway. *Id.* Upon entering the groundwater, the stormwater migrates below MWG's property. *Id.*

Because the Agency incorrectly describes the stormwater flow over land and into the groundwater, the Agency is also incorrect that stormwater from the highway could reach the Pond 2 groundwater monitoring wells "on the order of less than a week" *See Rec.*, p. 22 and Rec. Ex. A, ¶ 37. The Agency relies upon this conclusion in support of its conclusion that high hydraulic conductivity in the soil indicates the presence of CCR. The Agency's analysis to conclude that the stormwater reaches the Pond 2 monitoring wells within a week is flawed for two reasons. First, it relies upon data from just two sampling events from 2018 and 2019 despite having over ten years of data, and thus at least ten sampling events in the spring of each year. *See Rec. Ex. A*, ¶ 36. A review of the spring sampling events from 2010 to present shows that the concentrations of chlorides is usually higher in the spring, which is due to the winter road salt application and nothing more. Ex. 22, p. 6. Second, the Agency only relies upon a single sampling event that occurred after

a rain event to conclude that the soil has high hydraulic conductivity, resulting in rapid recharge. *See* Rec. Ex. A, ¶ 36. This is not a valid analysis because there are no samples of the groundwater *before* the precipitation event to provide a reference point for the data. Ex. 22, p. 7. Without an analysis of the groundwater both before and after a precipitation event, no scientific conclusion can be made about the rate of hydraulic conductivity in the soil based on the chloride concentrations from these two sampling events. *Id.*

To further rebut the Agency's conclusions, Mr. Maxwell calculated that it takes far longer than one week for the stormwater from the highway containing chlorides to reach the monitoring wells. Ex. 22, p. 6. Mr. Maxwell determined that once stormwater containing dissolved chloride from road salts percolates into groundwater in the uppermost aquifer (approximately 30 feet below the drainage ditch), it flows downgradient towards the Joliet 29 Site and the Des Plaines River at a maximum velocity equivalent to the rate of groundwater flow. *Id.* Using the average seepage velocity and conservatively assuming that the dissolved chloride flows at the same velocity as the groundwater, Mr. Maxwell concludes that it takes approximately 30 days for the stormwater entering the groundwater below the ditch to reach the upgradient MW-10, approximately 210 days to reach downgradient well MW-5, and approximately 300 days to reach downgradient wells MW-3 and MW-4. *Id.*

**f. There Are No Data Quality Issues with the May and August 2021 Groundwater Monitoring Events.**

The Agency alleges that data quality issues are present in the May and August 2021 groundwater sampling results based on its contention that certain total metals concentrations are lower than the dissolved metals concentrations. *See* Rec., p. 24 and Rec. Ex. A, ¶ 40. The Agency does not identify the metals nor the monitoring wells it claims are flawed. *Id.* The Agency's



allegation of data quality issues in the May and August 2021 groundwater sampling events, and suggestion that MWG's consultants may have switched the samples in the field, is highly concerning and belied by the facts. The Agency never indicated to MWG it had any data quality concerns prior to filing its Recommendation, despite numerous opportunities for the Agency to raise the issue either to MWG's counsel or technical personnel. Had the Agency raised this concern to MWG earlier or asked MWG for an explanation before filing the Recommendation, this issue could have been readily and favorably resolved.

A few results with dissolved metals concentrations greater than the total metals sampled is typical of metals analysis; it is not indicative of data quality issues. Ex. 22, p. 13. While total metals concentrations in groundwater are *usually* higher than dissolved metals concentrations from the same sample, Mr. Maxwell states that "it is unreasonable and not scientifically sound to expect that the total metals concentrations will be higher than dissolved metals 100% of the time." *Id.*, p. 12.

Mr. Maxwell performed side-by-side comparisons of the total and dissolved metals results for barium, boron, cobalt, and selenium in the May and August 2021 sampling events for monitoring wells MW-10, MW-3, MW-4, and MW-5. *Id.*, p. 13. He found that out of 32 total results for the metals for both total and dissolved metals, four exhibit concentrations of dissolved metals greater than total metals and each were below the groundwater protection standard. *Id.* Also, the differences in concentration were minuscule. For example, in MW-5, on August 30, 2021 the dissolved barium was 0.07 mg/L and the total metals was 0.069 mg/L, an insignificant difference of 0.01 mg/L. *Id.* Similarly, concentrations on the scale of parts per billion, such as cobalt, are so small it is to be expected that occasionally the total concentrations may not consistently be above the dissolved metal concentrations. *Id.* In total though, if there were quality-control issues at

collection, the dissolved metals concentrations would have been above the total metals for a majority of the metals and that is not the case here. *Id.*

Richard Gnat, of KPRG, also reviewed the August 2021 groundwater sample results for quality control issues, and found none. Ex. 23, Affidavit of R. Gnat, ¶¶ 8, 9. KPRG has collected the groundwater samples from Joliet 29 since approximately 2013. Ex. 23, ¶ 3. Mr. Gnat explained that the total metals analysis are placed in one sample container, and the dissolved metals analysis in a separate container. *Id.*, ¶ 7. There are no separate or individual sample containers for each metal. *Id.* Mr. Gnat noted that the chain of custody for the August 2021 sampling event indicates that the totals metals were field filtered, and contacted the project engineer Mark Wilson, who collected the samples. *Id.*, ¶ 9. As Mr. Wilson explains in his affidavit, he noted on the chain of custody document that the sample was field filtered solely referring to total dissolved solids, which is a separate container from the total metals sample container. Ex. 24, Affidavit of M. Wilson, ¶ 7. He confirmed that he did *not* field filter the total dissolved metals samples. *Id.* (emphasis added).

Mr. Gnat also analyzed the August 2021 groundwater data, comparing the totals with the dissolved results. He found that only the cobalt result showed the dissolved cobalt higher than the total cobalt at 0.0055 mg/L and 0.0034 mg/L, respectively. Ex. 23, ¶ 10. All the other total metals either equal or were higher than the dissolved. *Id.* Of even more significance were the results for arsenic. *Id.* The field filtered sample results for arsenic in all four groundwater wells were non-detect. *Id.* In comparison, the total metals results for arsenic in each well had trace detections of arsenic from 0.0012 mg/L to 0.0018 mg/L. *Id.* If the samples had been switched as the Agency suggests, the arsenic results would also be switched.

Mr. Maxwell explains that outlier results can be due to irregularities within the standard laboratory analytical methods approved by U.S. EPA for laboratory analysis of metals. Ex.22, p.

12. The quality assurance/quality control standards governing these laboratory analytical methods allow for certain calibration variances of the known analysis standards, which can result in variations in reporting of the data. *Id.*, p. 12-13. However, as long as the calibration data are within a certain range of accuracy and precision acceptance criteria, the laboratory can certify the results as performed in accordance with the standard U.S. EPA-approved methods. *Id.*, p. 13. Moreover, even if the laboratory performs total and dissolved groundwater sample analysis on two separate containers collected consecutively in the field (one filtered and one unfiltered) as quickly as reasonably possible, slight variations may be present due to the constant flow of groundwater. *Id.*, p. 13.

Nature is not a perfect laboratory and the Agency is wrong to pull individual results out of context to conclude there are quality control issues. Small variations in concentrations in the groundwater are to be expected, but, when looking at a large data set, such as at Joliet 29, the data shows there are no quality control issues with the groundwater monitoring results. *See Id.* and Ex. 23, ¶ 11.

**g. Groundwater Data Shows That MWG Can Meet the Closure Requirement.**

The groundwater data proves that MWG can meet the closure requirements by addressing “all areas affected by releases from the CCR surface impoundment” under the language of the proposed adjusted standard. *Rec.*, p. 18. The Agency specifically claims that “decontamination” of groundwater would need to be complete before closure is considered complete. *Id.* Given there are no groundwater exceedances associated with CCR constituents, and that the cobalt exceedances can be attributed to an alternate source (*i.e.*, road salt application), MWG can meet the groundwater closure requirements.

**II. Pond 2 is Not Constructed with CCR**

The Agency's Recommendation is entirely premised on the false, speculative assumption that MWG used CCR to construct Pond 2 in 2008. There are no facts to support that assumption. In addition to the absence of CCR constituents in the groundwater, no CCR was found in the boring logs taken surrounding Pond 2, and MWG's expert's evaluation of the construction drawings, photos and notes show that CCR *was not* used.

Further, the Agency's attempt to broaden the statutory definition of CCR through its use of the term "CCR material" is invalid. "CCR material" is not a defined term in the Act, and the Agency provides no definition or basis for it. Because "CCR material" is an Agency invention without legal significance, the Board should disregard the Agency's reliance upon it.

Similarly, the Agency's simplistic statement that because poz-o-pac is made with CCR, it is also CCR under the Act's definition, is wrong. That is the equivalent of stating concrete is cement, since cement is a raw ingredient for concrete. The opinion of Mr. Mateusz Radlinski, an expert in concrete and cement-based materials, demonstrates that the pozzolanic reaction that occurs when poz-o-pac is made changes the composition of the ash, such that it is no longer CCR as that term is defined in the Act. *See* Ex. 25, Exponent Report, and 415 ILCS 5/3.142.

**a. CCR was Not Used to Construct the Pond 2 Embankments.**

The Agency's claim that CCR was used during the relining project in 2008 is refuted by the evidence. Evidence from soil cores at Pond 2 taken and analyzed by three professional consultants using accepted methodologies confirm that CCR is not present in the embankments or used as structural fill material for Pond 2. Patrick Allenstein, of KPRG, drilled the 2005 borings and logged the soil in each boring at Pond 2. Ex. 26, Affidavit of P. Allenstein, ¶¶ 3-5. Mr. Allenstein confirmed that he is familiar with CCR, and would have identified it in a soil boring if

he saw it. *Id.*, ¶ 6. He also confirmed that he did not see CCR in the soil cores, other than CCR on the surface. *Id.*, ¶ 8. Mr. Allenstein's borings are notable because he consistently distinguished between ash/slag and other dark soil types in his boring log descriptions in the other boring logs he completed as part of a geotechnical analysis of six stations in 2005. *Id.*; see also 2005 KPRG Geotechnical Report, Rec Ex. G Attachment 3. Similarly, Steve Kroll of Patrick Engineering confirmed that as part of their logging practice, their engineers are familiar with the characteristics of CCR, and identify it in soil cores when observed. Ex. 27, Affidavit of S. Kroll, ¶¶ 9-10.<sup>5</sup> Mr. Kroll also confirms that CCR was not logged in the Joliet 29 soil cores. *Id.*, ¶ 11.<sup>6</sup>

Given the absence of ash beyond the top one foot from the 2005 borings and the general absence of bottom ash in the other six borings, MWG's consultant Mr. Dehlin of Sargent & Lundy explained in a January 18, 2022 letter to the Agency that "the bottom ash or slag identified within the upper foot of these borings are more likely to be from bottom ash particles present at the surface of the pond's access roads than ash being used as fill material." Rec. Ex. G, p. 4.

Further, as explained by Mr. Dehlin, "KPRG boring JS29-GT-3; Patrick Engineering borings B-MW-3, B-MW-4, and B-MW-10; and Geosyntec boring J-B-1 were all drilled through Pond 2's perimeter access road, if ash was used as fill material to construct the pond's embankments when they were built circa 1978, ash material would likely have been encountered in the corresponding boring logs." *Id.* The absence of CCR in the deeper layers of the Pond 2 soil cores means that ash was not used to construct Pond 2 or rebuild the slope of Pond 2 in the 2008 relining. *Id.*

---

<sup>5</sup> Andrew Gagnon, who logged the 2010 borings is no longer with Patrick Engineers.

<sup>6</sup> Geosyntec collected the boring logs in 2015, but was not available.

**b. CCR was Not Used in the HDPE Relining Construction as Subgrade.**

The primary source documents contemporaneous with the 2008 Pond 2 relining also show that the CCR was removed from Pond 2, the poz-o-pac remained in place at the bottom of Pond 2, and CCR was not used as fill material under Pond 2's new HDPE geomembrane liner, either as a cushion layer or for any other purpose. Rec. Ex. G, p. 3.

i. "Black silty gravel" Does Not Equate to CCR

The Agency presumes that MWG used CCR as fill based solely on the color of the "black silty gravel" material referenced in the History of Construction and on a photo. Rec. Ex. A, ¶ 17. The Agency's only basis is Ms. Martin's statement that she is "not aware" of any black gravel sources within a reasonable distance of Joliet 29, and a selective citation to a 2006 Federal Highway Administration ("FHWA") guidance document. Ms. Martin incorrectly claims that the 2006 FHWA guidance states that "dark gray to black soils represent organic material", which she concludes would not be suitable as fill material. Rec. Ex. A, ¶ 17 (citing Rec. Ex. F, 4-10). Ms. Martin conveniently ignores the complete sentence from which she selectively extracted the above-quoted conclusion. The complete sentence explains that an identification marker of organic soils are that they are "dark gray and black and sometimes dark brown colors, although not all dark colored soils are organic" Rec. Ex. F, 4-10 (emphasis added). As the FHWA acknowledges, merely because the material is dark, does not mean it is only organic material.

MWG's consultant Mr. Maxwell also confirms that, "[m]erely because the silty gravel was described as black by the person logging the soil core does not automatically mean it is CCR." Ex. 22, p. 4. Mr. Maxwell notes that none of the soil boring logs state they followed the Munsell Color System, a standard method to visually identify and match color, including in soils, therefore, there

is no way to objectively determine whether the “black” was a true black or merely a dark color.

*Id.*

Mr. Maxwell states that there are potential borrow sources of dark fill soils available in the area of the Joliet 29 Station that are not CCR. In a recent Phase II Environmental Site Assessment (“ESA”) WCG performed at a site approximately 1.5 miles from the Joliet 29 Station, dark colored soil were identified in borings throughout multiple acres of the site. *Id.* Similar to Joliet 29 Pond 2, the soils at the other local site were described by the WCG geologist as a mixture of dark silts and clays, also including sand and gravel. *Id.* CCR materials were not identified during the investigation. *Id.* The data collected from the Phase II ESA at the nearby site indicates these fill soils will not have a detrimental impact to groundwater because a comparison of the soil and groundwater data to the remediation objectives under the TACO regulations show that the conditions were deemed protective of human health and the environment. *Id.* (citing 35 Ill. Adm. Code Part 742).

ii. The 2008 Construction Drawings Demonstrate MWG Did Not Use CCR

Sargent & Lundy’s January 18, 2022 letter and exhibits, which are attached as Exhibit G to the Agency’s Recommendation, do not show that CCR was used as fill during the 2008 Pond 2 liner construction. Sargent & Lundy’s letter explained the 2008 liner project and clarified the contents of the historical construction documents. *See* Rec. Ex. G. However, the Agency largely ignores Sargent & Lundy’s explanation and supporting documents. *See* Rec. Ex. A, ¶¶ 19, 21-23.

As Mr. Dehlin explained, when MWG and its contractors removed all the CCR from the pond, the poz-o-pac was revealed to be in good condition, which changed the relining project scope. Prior to issuing the project’s design drawings for bids in the fall of 2007, the project engineer removed the note from the preliminary version of Sheet No. C020 instructing the contractor to

remove Pond 2's existing liner, and revised the identification of the Pond 2 subgrade shown in Section A on Sheet No. C030 from "Native Soil" to "Subgrade Soil." Rec. Ex. G, p. 6 (The bid versions of Sheet Numbers C020 and C030 and the other design drawings issued for bids are included as Attachment 7 to Rec. Ex. G). "Subgrade soil" does not refer to CCR. It refers instead to the existing subsurface that did not have to be removed given the decision to leave the intact poz-o-pac liner in place. *Id.*

Because the poz-o-pac was not removed, the Brieser Construction Company ("Brieser") only needed to do minor cut and fill work to establish the specified slopes for the floor of the Pond 2 and remove any unsuitable material above the liner. Rec. Ex. G, p. 7 (citing Attachment 7). The construction documents show that the unsuitable material above the liner was the CCR that remained in the bottom of the pond - - and that CCR was removed. On April 17, 2008, Brieser submitted Field Change Request #2 to MWG noting a significant change to the project was necessary because "unsuitable material that [was] deposited in [the bottom of] the pond" needed to be removed. *Id.* (citing Attachment 8). Brieser's job invoices documenting the work describe that they removed approximately 6 inches of CCR from the bottom of the pond. *Id.* (citing three Brieser Job Invoices in Attachment 9 which identifies the material to be removed as "coal residue", and confirming it was removed). On April 28, 2008, the project engineer inspected Pond 2's subgrade for conformance with the construction specifications for preparing the subgrade and found it suitable, except for a hole that was immediately filled. *Id.*, p. 8 (citing Attachment 10, field notes of the project engineer). Based on the facts that (1) the poz-o-pac was left in place as subgrade, (2) the CCR was identified as unsuitable for the subgrade and was removed from the bottom of Pond 2, and (3) that the subgrade was inspected and found to conform with the objective



requirements outlined in the project specifications, the evidence shows that CCR material was not used as subgrade. *Id.*

By April 30, 2008, Brieser had finished the subgrade preparation work and had installed Pond 2's new geomembrane liner and the 16-oz non-woven geotextile cushion layer between the new liner and the original poz-o-pac liner. *Id.* In a photograph of the construction taken on April 30, 2008, the first panels of the new HDPE geomembrane liner and underlying geotextile being installed are seen along the interior side slope of Pond 2's eastern embankment. The top surface of the poz-o-pac is visible along the pond floor and interior side slope, and the non-woven geotextile cushion layer is being placed in direct contact with the original poz-o-pac liner. *Id.* The new geomembrane liner is being installed directly over the geotextile cushion layer. *Id.* This construction sequencing and layering for Pond 2's new liner follow Sections A, B, and C on the as-built / record drawing of Sheet C031 (dated December 19, 2008) included in Attachment 10 to Recommendation Exhibit G.

The Agency rebuttal of this evidence is vague conjecture that the April 30, 2008 photograph is "potentially" showing black silty gravel that it speculated could be CCR based solely on its color. Rec. Ex. A, ¶ 19. But additional photos, attached to the Sargent & Lundy's March 23, 2022 letter from Mr. Dehlin show that the material is not CCR. *See* Ex. 28, Attachment 1. Another photo showing a close-up view of the Pond 2 relining in better lighting and shows the material is actually dark brown sand and gravel, not black silty gravel or CCR. He states further that:

“[t]his material observed along the interior slope of Pond 2's eastern embankment is consistent with the soils observed at similar elevations in the three borings of which I am aware that have been drilled through Pond 2's eastern embankment: B-MW-3 and B-MW-4 drilled by Patrick Engineering in 2011 and boring J-B-1 drilled by Geosyntec in 2016. respectively.”

Ex. 28, p. 2 (citing Attachment 2, p. 25-28, Attachment 3, p. 3- 4).

In further support of the absence of evidence of use of CCR in the 2008 project, Mr. Dehlin also compared the topographic maps prepared before and after the project. As part of the project, the contractor regraded the side slopes to achieve a more gradual slope. Ex. 28, p. 3. According to the topographic maps, the contractor cut the material from the top of the slope and installed material at the base making the slope less steep. *Id.* Because the slope was originally steep and yet stable, Mr. Dehlin concluded that the embankment material must be a cohesive material, such as clay. He noted that a boring near the regrading showed clay within the core, further supporting the conclusion that the material used to regrade the pond was clay and not CCR. *Id.*, p. 4.

**c. Poz-o-pac is Not CCR.**

The Agency's claim that poz-o-pac is CCR merely because it is made with fly ash and boiler slag is also not correct. MWG engaged Dr. Mateusz Radlinski, an expert in concrete and cement-based materials, to evaluate the Agency's claim that poz-o-pac is CCR. As Dr. Radlinski states, poz-o-pac is formed by a chemical reaction (*i.e.* the pozzolanic reaction) between the lime and fly ash which forms a hardened cementitious paste. Ex. 25, Exponent Rpt., p. 2-3 and Rec. Ex. C, p. 4. The pozzolanic reaction of lime and fly ash fundamentally alters the chemical composition of the mixture to form cementitious matrix that binds and holds the aggregate particles together. *Id.* Dr. Radlinski also states that fly ash is commonly used as a supplement or replacement of portland cement when making concrete to improve concrete properties, and analogizes poz-o-pac to concrete, including concrete containing fly ash. Ex. 25, p. 3. Because both concrete and poz-o-pac use fly ash, Dr. Radlinski concludes that "much like it would be inappropriate to characterize [concrete] containing fly ash as "CCR" or "CCR material," it is not appropriate to characterize Poz-o-pac as "CCR" or "CCR material." *Id.* Similarly, Dr. Radlinski states that the boiler slag that was used as aggregate is physically encapsulated in the hardened cementitious matrix, just like the

aggregate particles used in concrete. *Id.* There is a critical distinction between an encapsulated cement-like material such as poz-o-pac versus unencapsulated ash byproducts from burning coal.

The plain language of the CCR definition applies to “fly ash, bottom ash, boiler slag, or flue gas desulfurization material generated from burning coal for the purpose of generating electricity...” 415 ILCS 5/3.142. Because of the changes in chemical composition and physical encapsulation of the raw CCR ingredients, Dr. Radlinski concludes that poz-o-pac does not meet the definition of CCR. Ex. 25, p. 3.

The Agency’s proposed expansion of the definition of CCR to encompass any material that contains CCR is an extraordinary oversimplification that if accepted by the Board, would have far-reaching consequences. Millions of tons of pozzolan-stabilized base (“PSB”), which includes poz-o-pac, are used as road base throughout Illinois. *See* Rec. Ex. C, p. 3. The FHWA report attached to the Agency’s Recommendation as Exhibit C states that over 100 projects in Illinois used poz-o-pac for state and county roads, and Illinois was one of the states that most frequently used poz-o-pac. *Id.*, p. 2-3. It further states that “[i]t has been conservatively estimated that since the 1970’s at least 25 to 30 million tons of PSB material have been produced and placed in the United States. One-third to one-half of all the PSB material placed prior to 1990 is thought to have been placed in the metropolitan Chicago area.” *Id.*, p. 3 (emphasis added). In fact, the Village of Long Grove specifically identifies poz-o-pac as an acceptable base material for use on residential streets. *See* Village of Long Grove Ord. 6-6-2(A)(11).<sup>7</sup> If the Agency’s expanded definition of CCR was

---

<sup>7</sup> *See also, e.g.* City of Morris, IL Municipal Code Sec. 16.12.150 (permitting street construction with “Poz-o, lanic base course”); University Park, IL Code of Ordinances Sec. 1218-05(2) (stating that roadway pavements may be installed with “Pozzolanic mix”); Elmhurst, IL Code of Ordinances Sec. 23.11(2) (stating that “pozzolanic base course” is satisfactory for street construction); Zion, IL Code of Ordinances Sec. 82-107b- (a)(1)(b) (base course is permitted to be constructed with “Pozzolanic”).

accepted, then each of the over 100 projects in Illinois totaling approximately 10 to 15 million tons of PSB could be subject to investigation and regulation under the CCR Rules.

**d. The Agency's Conclusions are Based on Conjecture.**

The Agency initially describes its contentions that “CCR materials” are present in the embankments or underlying Pond 2 as inferences, stating that the black silty gravel is “likely” or “potentially” CCR or CCR combined with other materials. However, as the Recommendation continues, the Agency advances unsupported inferences about the presence of CCR as a proven factual premise upon which it bases recommended denial of the adjusted standard. The Agency also invents a term “CCR material”, which is not defined in the Act. The Agency does not provide a definition for that term, nor how the term relates to the definition of “CCR” in Section 3.142 of the Act. 415 ILCS 5/3.142.

For example, in Ms. Martin's affidavit, which forms the primary basis for the claims in the Recommendation, she initially claims that she is “not confident” regarding CCR materials left in place in the 2008 relining and that the black silty gravel is “likely” fly ash mixed with poz-o-pac or gravel (Rec. Ex. A, ¶¶ 13, 17), yet she later conclusively proffers without any additional evidentiary support that the poz-o-pac and the black silty gravel “are CCR or CCR combined with other materials” and that there was “CCR material used as structural fill or foundational backfill” (Rec. Ex. A, ¶ 26), and that there are “CCR materials placed underneath the liner and in the embankments of Pond 2.” (Rec. Ex. A, ¶ 38). *See also, e.g.* ¶ 27 (L. Martin testifying that CCR materials were “used to construct the impoundment”); ¶ 33 (L. Martin testifying that Pond 2's embankments “contain CCR materials”); ¶ 37 (L. Martin testifying that there are “CCR materials placed under the liner at Pond 2”). The Board should not accept the Agency's speculation on the presence of CCR or the Agency's vague “CCR material” term, as an adequate basis for denial of

the adjusted standard, particularly when the Agency has not submitted any support for its assertions. Rather than accepting the Agency's guesswork and faulty premises, the Board should focus on the verifiable evidence showing the absence of CCR in the Pond 2 construction, and the absence of the potential for environmental harm to grant this adjusted standard.

**III. The Adjusted Standard is Justified Because Pond 2 has a Competent HDPE Liner That Can be Decontaminated.**

The Board determined in its Opinion and Second Notice Order that a competent, uncontaminated existing geomembrane liner may be left in place if the owner or operator demonstrates that the liner is not contaminated with CCR constituents. Order, p. 99. The Agency claims that the Board only addresses removal of a synthetic liner, and did not address additional requirements in 845.770(a)(1) to remove contaminated soils or the situation where it claims that CCR has been used as structural and foundational fill of a CCR surface impoundment. However, the Board need not address that situation here because it is not at issue – CCR material is not used as structural and foundational fill in Pond 2. *See* Resp. Section II.

The Agency's Recommendation also does not dispute that the HDPE liner may be properly decontaminated. Rec. p. 21; *See also*, Pet., p. 4-5 (citing Pet. Ex. 3, D. Nielson's expert opinion demonstrating that a liner may be decontaminated, without requiring the entire liner to be removed). Rather, the Agency contends that Pond 2's liner must demonstrate competence before it can be decontaminated. *Id.* While "competent" is not a defined term, MWG's consultant David Neilson interprets the term to mean "undamaged" and notes that visual inspections for any damage would also occur during decontamination, with any potential damage repaired. Pet. Ex. 3, p. 4, 6. The Agency however now claims that competence means a demonstration that: (1) seals between sheets of the liner have not parted or otherwise become separated; (2) the liner has not been

damaged by the gravel underlying or overlying the liner; and (3) exposure to the elements has not broken down the liner seals. Rec. p. 21 and Rec. Ex. A, ¶ 31. Citing only to general guidance and no specific information related to the Pond 2 liner, the Agency concludes that Pond 2's HDPE liner is "likely" damaged or degraded due to being placed over gravel, or exposure to elements. Rec., p. 20 and Rec. Ex. A, ¶¶ 29, 30.<sup>8</sup>

The construction documents do not support the Agency's assertion that gravels in the subgrade of Pond 2 are likely to causing perforations in the HDPE liner. *Id.* As detailed in both MWG's Petition and the Recommendation, Pond 2's HDPE liner is cushioned by a geotextile layer both on top and on the bottom which protects the liner, in addition to multiple other layers. Pet., p. 8 and Rec., p. 9; *see also* Ex. 28, p. 5-6. The descriptions of the liner components expressly note that the purpose of these layers is to "avoid punctures on the geomembrane." Ex. 28, p. 5-6. Indeed, Mr. Dehlin explains in his report that the geotextiles protect Pond 2's HDPE geomembrane liner from punctures and damage like that documented in the 2011 technical paper referenced by the Agency. *Id.*, p. 5. Mr. Dehlin also clarifies that the liners referenced in the 2011 paper did not have geotextile cushions and were placed directly upon granular soils, thus the liner conditions and placement described in the referenced document are not similar to Pond 2's HDPE liner. *Id.*

Additionally, it is well-documented that in the 2008 relining, the subgrade soils were determined to be acceptable in multiple levels of review by qualified professionals. *See* Rec. Ex. G, p. 6-8. This included a demonstration that the subgrade underlying the geomembrane is comprised of "satisfactory soils" that are "free of rock or gravel larger than 3 inches in any

---

<sup>8</sup> This is in direct contrast to Mr. Neilson's report, which provided a specific example of long-term use of HDPE liners. Specifically, an analysis of the condition of a geomembrane after over 25 years of use in a landfill leachate pond found the liner was still in good condition, with little sign of degradation. Pet. Ex 3 (citing Attachment D). The liner was successfully used with clean water. *Id.*

dimension.” Rec. Ex. G Attachment 7, Section 02300-3, Part 2.01(B); *See also*, Section 02300-1, Part 1.01(A) (preparation of subgrade includes, “clearing and grubbing vegetation and removing rocks and debris greater than 3 inches in diameter alongside slopes and base of impoundments”) and Section 02300-7, Part 3.05 (B) (stating same).

The construction records also show that these project specifications related to suitability of subgrade soils were diligently followed in the field during the Pond 2 relining. As previously noted, Brieser’s Field Change Request 2, identified “unsuitable material” as subgrade in Pond 2 and directed that it be removed pursuant to the project specifications. Rec. Ex. G Attachment 8. And NRT’s Field Directive # 1, which verifies that the poz-o-pac was left in place, specifically directed the removal of “rocks that may pose a hazard to the geomembrane” from the subgrade. Rec. Ex. G Attachment 10, at Att. B. After the completion of the 2008 Pond 2 relining project, Brieser submitted a certification that installation was in accordance with project specifications. *Id.*, Attachment 10, at Att. A6. Similarly, the Geomembrane Installer, Clean Air and Water Systems, certified the acceptance of the subgrade on May 8, 2008. *Id.*, Attachment 10, at Att. A5; *See also* Attachment 7, Section 02300-7, Part 3.05 (F); Section 02600-11, Part 3.02 (A) (noting that the installer inspection must verify that “there are no potentially harmful foreign objects present, such as sharp rocks and other deleterious debris” and directs that any such objects to be removed).

Also, the Agency’s speculation that the Pond 2 liner has suffered degradation due to exposure to the elements is baseless. The Geosynthetic Research Institute (GRI) (which is referenced in the 2008 magazine article cited by Ms. Martin) “estimates a lifespan greater than 36 years for a black, 60-mil HDPE geomembrane conforming to GRI’s GM13 Standard Specification exposed to a dry and arid climate.” Ex. 28, p. 6. But a white geomembrane, like the one in Pond 2, lasts longer than a black geomembrane because it does not absorb as much heat from the sun. *Id.* Here, MWG

relined Pond 2 approximately 14 years ago with a white geomembrane, well within even the shorter life-span of a black geomembrane. *Id.* Also, Pond 2 contained CCR and water until 2019, shielding most of the geomembrane from the elements. *Id.*, p. 6-7. Based on these facts, Mr. Dehlin concluded that the Pond 2 liner has at least 22 more years of service, but that estimate is conservative because of its color and that the pond has been full for most of its life. Ex. 28, p. 7.

**IV. MWG has Adequately Demonstrated That CCR is Not Present, and No Additional Information is Necessary.**

Requiring MWG to test the Pond 2 embankment material utilizing test method ASTM D3987-85, or the “shake test,” is unnecessary and overly burdensome. The Agency’s premise for the requirement is its assumption that CCR was used in the 2008 relining. But, no facts or data support that assumption. MWG should not be required to prove a material is coal combustion byproduct (“CCB”) for beneficial reuse when it is not CCR. The poz-o-pac chemical data, soil boring data, and primary source construction documentation already demonstrate that CCR is not present.

Also, MWG has demonstrated the absence of the potential for groundwater contamination of Pond 2, or the “leaching potential” of the material in its embankments. The extensive groundwater monitoring data showing no GWPS exceedance and the absence of the signature constituents of CCR is adequate evidence that Pond 2’s embankments are not leaching coal ash constituents. Thus, the Board already has sufficient information without the shake test to determine that as constructed, and even before the proposed decontamination of the HDPE liner, Pond 2 does not have the potential to cause groundwater contamination from CCR.

**V. Consistency with the Federal Rule**

The proposed adjusted standard is consistent with the federal CCR rule, and the Agency agrees in its Recommendation that MWG is “correct that the federal rule does not explicitly require removal of decontaminated liners for a closure by removal action.” Rec. p. 28. As MWG describes



in its Petition, the federal March 3, 2020 proposal cited by the Agency regarding closure by removal is only a proposal, and it has not been adopted by the U.S.EPA. Moreover, an isolated preamble statement in a proposed federal rule is an insufficient basis for including a requirement to remove every piece of equipment connected to CCR regardless of its condition.

**VI. CONCLUSION**

MWG submits that the Agency Recommendation is not supported by the relevant facts. Years of groundwater data, boring logs, pond construction documents and expert opinion demonstrate that CCR is not present at Pond 2 and there is no CCR release impacting groundwater in the vicinity of Pond 2. Because the Agency's Recommendation ignores all of this evidence and instead relies on the erroneous, unproven premise that CCR is present, it does not provide a defensible basis for denying the requested adjusted standard relief or conditioning that relief in the manner suggested by the Agency. MWG looks forward to presenting additional and more specific evidence to the Board supporting its Petition for Adjusted Standard to reuse the Pond 2 liner.

Respectfully submitted,  
Midwest Generation, LLC

By: /s/ Kristen L. Gale  
One of its Attorneys

Kristen L. Gale  
Susan M. Franzetti  
Molly Snittjer  
Nijman Franzetti LLP  
10 S. LaSalle St, Suite 3600  
Chicago, Illinois 60603  
(312) 262-5524  
[kg@nijmanfranzetti.com](mailto:kg@nijmanfranzetti.com)  
[sf@nijmanfranzetti.com](mailto:sf@nijmanfranzetti.com)  
[ms@nijmanfranzetti.com](mailto:ms@nijmanfranzetti.com)

**INDEX OF EXHIBITS FOR MIDWEST GENERATION, LLC'S  
PETITION FOR ADJUSTED STANDARD FOR THE JOLIET 29 STATION**

<b>Exhibit #</b>	<b>Description</b>	<b>PDF Page #</b>
Exhibit 1	Affidavit of William Naglosky, May 7, 2021	Pet. 33
Exhibit 2	Affidavit of David Nielson, P.E., May 10, 2021	Pet. 38
Exhibit 3	Expert Opinion of David Nielson, P.E., May 9, 2021	Pet. 41
Exhibit 4	Pre-filed Expert Testimony of David Nielson on behalf of Midwest Generation, LLC, <i>In the Matter of: Standards for the Disposal of Coal Combustion Residuals in Surface Impoundments: Proposed New 35 Ill. Adm. Code 845, PCB 20-19</i>	Pet. 556
Exhibit 5	Excerpt of September 30, 2020 Hearing Transcript, <i>In the Matter of: Standards for the Disposal of Coal Combustion Residuals in Surface Impoundments: Proposed New 35 Ill. Adm. Code 845, PCB 20-19</i>	Pet. 574
Exhibit 6	Excerpt of Midwest Generation, LLC Pre-Filed Answers, <i>In the Matter of: Standards for the Disposal of Coal Combustion Residuals in Surface Impoundments: Proposed New 35 Ill. Adm. Code 845, PCB 20-19</i>	Pet. 577
Exhibit 7	Excerpt of Agency Final Comment, <i>In the Matter of: Standards for the Disposal of Coal Combustion Residuals in Surface Impoundments: Proposed New 35 Ill. Adm. Code 845, PCB 20-19</i>	Pet. 583
Exhibit 8	Excerpt of Midwest Generation, LLC's Response Comment, <i>In the Matter of: Standards for the Disposal of Coal Combustion Residuals in Surface Impoundments: Proposed New 35 Ill. Adm. Code 845, PCB 20-19</i>	Pet. 587
Exhibit 9	Excerpt of August 25, 2020 Hearing Transcript, <i>In the Matter of: Standards for the Disposal of Coal Combustion Residuals in Surface Impoundments: Proposed New 35 Ill. Adm. Code 845, PCB 20-19</i>	Pet. 593
Exhibit 10	NPDES Permit for the Joliet 29 Station	Pet. 597
Exhibit 11	Annual and Quarterly Groundwater Monitoring Report, Joliet 29 Generating Station, Jan. 21, 2021	Pet. 623
Exhibit 12	Joliet 29 Station General Flow Diagram with NPDES Outfalls	Pet. 753
Exhibit 13	Illinois EPA Construction Permit for Liner Replacement of Ponds 1 and 2	Pet. 755
Exhibit 14	Illinois EPA Construction Permit for Liner Replacement of Pond 3	Pet. 758
Exhibit 15	Construction Documentation for Liner Replacement of Ponds 1 and 2	Pet. 763

Electronic Filing: Received, Clerk's Office 3/24/2022

MWG Response to Recommendation

Joliet 29 Station

P. 28

Exhibit 16	Construction Documentation for Liner Replacement of Ponds 3	Pet. 910
Exhibit 17	Compliance Commitment Agreement for Joliet 29 Station	Pet. 1042
Exhibit 18	Joliet 29 CCR Compliance Annual Groundwater Monitoring and Corrective Action Report – 2020	Pet. 1049
Exhibit 19	Evaluation of Sediment Quantities in Joliet Generating Station’s Pond 1 and Pond 3 and Powerton Generating Station’s Service Water Basin, Nov. 19, 2020	Pet. 1132
Exhibit 20	Sampling Location Discussion as part of Evaluation of Sediment Quantities in Joliet Generating Station’s Pond 1 and Pond 3 and Powerton Generating Station’s Service Water Basin, Feb. 26, 2021	Pet. 1149
Exhibit 21	Notice of Intent to Initiate Closure Joliet 29 Station Pond 2	Pet. 1158
Exhibit 22	Supplemental Expert Opinion of Michael Maxwell (Weaver Consultants Group North Central, LLC), dated March 21, 2022	Resp. 33
Exhibit 23	Affidavit of Richard Gnat, KPRG, March 18, 2022	Resp. 217
Exhibit 24	Affidavit of Mark Wilson, KPRG, March 15, 2022	Resp. 222
Exhibit 25	Expert Opinion of Mateusz Radlinski Ph.D. (Exponent, Inc.), March 21, 2022	Resp. 225
Exhibit 26	Affidavit of Steven Kroll, Patrick Engineering, March 18, 2022	Resp. 236
Exhibit 27	Expert Opinion of Mateusz Radlinski Ph.D. (Exponent, Inc.), March 21, 2022	Resp. 240
Exhibit 28	Expert Opinion of Thomas Dehlin (Sargent & Lundy), March 23, 2022	Resp. 242

**INDEX OF AGENCY RECOMMENDATION EXHIBITS CITED BY  
MIDWEST GENERATION, LLC IN ITS RESPONSE**

<b>Exhibit</b>	<b>Description</b>	<b>PDF Page #</b>
Exhibit A	Affidavit of Lauren Hunt Martin, February 4, 2022	Rec. 36
Exhibit C	Federal Highway Administration, Publication No. FHWA-RD-97-148, <i>User Guidelines for Waste and Byproduct Materials in Pavement Construction</i>	Rec. 60
Exhibit F	Federal Highway Administration, Publication No. FHWA NHI-06-088, <i>Soils and Foundations Reference Manual – Volume I</i> , March 2006	Rec. 501
Exhibit G	Expert Opinion of Thomas Dehlin (Sargent & Lundy), January 18, 2022	Rec. 964
	Attachment 3: KPRG Geotechnical Analysis of Soils Surrounding Settling Basins/Ponds, October 13, 2005	Rec. 1029
	Attachment 5: Expert Opinion of Michael Maxwell (WCG), December 6, 2021	Rec. 1282
	Attachment 7: 2008 Re-Lining Technical Specifications	Rec. 1539
	Attachment 8: 2008 Re-lining Field Change Request Nos. 1 and 2	Rec. 1625
	Attachment 9: 2008 Project Relining Invoices	Rec. 1628
	Attachment 10: 2008 Re-Lining Construction Records	Rec. 1632
	Attachment 11: 2008 Re-Lining Construction Photograph	Rec. 1779
Exhibit M	MWG Letter to Illinois EPA, August 12, 2012	Rec. 1825
Exhibit O	Pond 2 Groundwater Monitoring Results, Q2 2021	Rec. 2009

# **EXHIBIT 22**



**Supplemental Expert Opinion in Response to RECOMMENDATION OF THE ILLINOIS ENVIRONMENTAL PROTECTION AGENCY filing dated February 4, 2022**

Petition of Midwest Generation for an Adjusted Standard, Joliet 29 Station

AS 2021-001

March 21, 2022

WCG Project No. 5244-302-07-01

Weaver Consultants Group North Central, LLC (WCG) provides the following supplemental expert opinions regarding groundwater conditions at the coal combustion residuals (“CCR”) surface impoundment (Pond 2) at the Joliet 29 Station. This supplemental opinion is provided in response to the RECOMMENDATION OF THE ILLINOIS ENVIRONMENTAL PROTECTION AGENCY, filed Before the Illinois Pollution Control Board on February 4, 2022 pertaining to the above referenced matter (“Illinois EPA Recommendation”).

In particular, the following supplemental expert opinions are being provided in response to information contained in the Illinois EPA Recommendation concerning the following subjects:

1. Nature of the “black silty gravel” reportedly utilized as structural fill for a portion of the Pond 2 embankment alleged by Illinois EPA to be CCR;
2. Contaminant transport mechanisms related to migration of chloride from U.S. Highway 6 located north of Pond 2 to the groundwater monitoring wells located around Pond 2; and
3. Presence of cobalt in groundwater sampled at MW-4 as an indicator of CCR impacts.

*Our Expert Opinion in Support of Midwest Generation LLC’s Petition for Adjusted Standard Joliet 29 Station*, dated December 6, 2021 indicated that groundwater data demonstrated that the groundwater is not impacted by CCR that was historically in Pond 2, nor indicative of potential sources of CCR outside the pond. The additional information presented herein in response to the above technical issues included in the Illinois EPA Recommendation further supports WCG’s analysis and opinions.

### **Information Considered**

For purposes of the following expert opinion, WCG has reviewed publicly available information concerning the Midwest Generation (“MWG”) Joliet 29 Station on the CCR Rule Compliance Data and Information website (available at: <https://www.nrg.com/legal/coal-combustion-residuals.html>), MWG’s Illinois CCR Rule Compliance Data and Information website (available at: <https://midwestgenerationllc.com/illinois->

[ccr-rule-compliance-data-and-information/](#)) and other information provided by MWG. These references are listed in **Exhibit A** and referenced throughout this document.

## Background/Introduction

Exhibit A to the Illinois EPA Recommendation included an affidavit from Lauren Hunt Martin, Environmental Protection Geologist III in the Hydrogeology and Compliance Unit within the Groundwater Section of the Illinois EPA Bureau of Water. This affidavit presents, in part, a discussion supporting the conclusion that “black silty gravel” reported to be part of the foundation soils beneath the Pond 2 embankment is CCR. This conclusion is supported in Paragraph 17 in Exhibit A to the Illinois EPA Recommendation, which states that the Illinois EPA is “not aware” of any borrow sources within a reasonable distance to support economically shipping black inorganic source material from a natural source. Further, Paragraph 18 states that MWG has not provided “any local source of geotechnically suitable black material that is not CCR”.

As evidence that potential borrow sources of dark fill soils are available in the area of the Joliet 29 Station, WCG has provided a discussion below referencing a prior Phase II Environmental Site Assessment performed at a nearby site containing significant quantities of dark fill soils.

Exhibit A to the Illinois EPA Recommendation also includes a description of how groundwater monitoring results for chloride demonstrate “the potential for leaching of metals from the CCR materials placed under the liner at Pond 2”.<sup>1</sup> According to Illinois EPA’s analysis, the Illinois EPA concluded:

*...that chlorides, which are presumably present in road salts applied on US Highway 6 and thus in the top-soils on the north side of the impoundment and extending into the US Highway Right-Of-Way storm water drainage system, are exhibiting the recharge that is occurring at the site through the surface into the immediate groundwater through a material with high hydraulic conductivity providing a rapid infiltration rate on the order of less than a week.<sup>2</sup>*

A technical analysis of the contaminant transport mechanisms resulting in chloride concentrations from U.S. Highway 6 just north of Pond 2 is provided below. This analysis is provided in response to the above conclusions included in the Illinois EPA Recommendation.

Further, paragraphs 39-41 in Exhibit A to the Illinois EPA Recommendation state, in summary:

---

<sup>1</sup> IPCB, February 4, 2022, Exhibit A, Paragraph 37.

<sup>2</sup> IPCB, February 4, 2022, Exhibit A, Paragraph 37.

- Groundwater analytical results from monitoring wells around Pond 2 from 2015 through 2021 indicate exceedances of Section 845.600 groundwater protection standards (GWPS) for cobalt at MW-4 for eight of the 13 values reported in MWG's 2021 Q3 Data Summary Posting (included as Exhibit O to the Illinois EPA Recommendation);
- "Data quality issues" are associated with dissolved or field filtered groundwater sampling results vs. total (unfiltered) results collected since the Part 845 regulations became effective (data collected in May 2021 and August 2021); and
- Groundwater quality data from MW-3 and MW-5 exhibited cobalt detections (below the GWPS) in May and August 2021 and MW-5 also exhibited cobalt detections (below the GWPS), but above the laboratory reporting limit in October 2015 and February 2016. However, Illinois EPA contends that the concentrations could have been greater, "if the total metals sample collection methods had been followed".

The owner or operator of a CCR surface impoundment is afforded an opportunity under 35 IAC 845.650(e) to attribute an exceedance of the GWPS to an alternate source and not the CCR surface impoundment. Given that the Illinois EPA Recommendation cites cobalt groundwater data as attributable to CCR impacts,<sup>3</sup> a closer examination of the data has been performed, focused upon cobalt, as well as the lack of presence of other common CCR indicator parameters in the groundwater at concentrations exceeding the 35 IAC 845 GWPS. The characteristics of the CCR historically produced at the Joliet 29 Station has been examined first, followed by a presentation of an alternate source of cobalt reported in the groundwater at MW-4.

Finally, I provide an analysis of the alleged "data quality issues" regarding the total vs. dissolved metals concentrations discussed in the Illinois EPA Recommendation.

### **Nature of "Black Silty Gravel" Used as Portion of the Pond 2 Embankment**

Ms. Martin claims that the "black silty gravel" can only be CCR because, she claims that the local quarried rock is typically lighter in color and that they are not "aware" of any quarries or borrow sources within a reasonable distance for black inorganic source material.<sup>4</sup> The Agency does not provide a citation or other source for this information. The Agency appears to be stating that solely because the silty gravel has been interpreted as black, it can only be CCR.

---

<sup>3</sup> IPCB, February 4, 2022, pg. 22-23.

<sup>4</sup> Agency Recommendation, Ex. A, L. Martin Affidavit, ¶17.



March 21, 2022

---

Merely because the silty gravel was described as black by the person logging the soil core does not automatically mean it is CCR. None of the soil boring logs state that they followed the Munsell Color System, which is a standard method to visually identify and match color, including in soils.<sup>5</sup> Thus, there is no way to objectively determine whether the “black” was a true black or merely a dark color.

Additionally, in my experience, dark colored soils are found in the area of the Joliet 29 Station. I have recently assisted WCG to perform a Phase II Environmental Site Assessment (“Phase II ESA”) on a site within 1.5 miles of the MWG Joliet 29 Station that found dark colored soil that was not CCR. As part of the Phase II ESA, WCG advanced 10 soil probes at this site. The primary intent of the Phase II ESA was to evaluate whether historical filling of the property represented a threat to human health or the environment. Our investigation identified 1 to 4 feet of fill soils over multiple acres of the site. The fill soils were described by the WCG Geologist as a mixture of dark silts and clays, also including sand and gravel. CCR materials were not identified during the investigation.

Based on the analytical data collected during the site investigation, the fill soils were deemed to be generally consistent with typical urban fill material encountered in the Chicagoland area, which includes Joliet. The soil and groundwater data was compared to Tier 1 remediation objectives under the 35 IAC 742 Tiered Approach to Corrective Action Objectives (TACO) regulations, and site conditions were deemed to be protective of human health and the environment under the TACO regulations.

The results of the Phase II ESA performed a short distance from the Joliet 29 station indicate that economic quantities of darker fill soils are in fact available from the local area. Moreover, the data collected from the Phase II ESA indicates that the fill soils will not have a detrimental impact to groundwater. This information, combined with the other information presented below concerning chloride impacts and groundwater chemistry downgradient of Pond 2 indicates that this “black silty gravel” soil is not CCR.

## Evaluation of Contaminant Transport of Chloride

The Illinois EPA and MWG previously agreed in 2012 that exceedances of the 35 IAC Section 620.410 Groundwater Quality Standard for chloride in groundwater at monitoring wells around Pond 2 are due to road salts applied to U.S. Highway 6 north of Pond 2 (“highway”).<sup>6</sup> Ms. Martin states in her affidavit that

---

<sup>5</sup> U.S. Dept. of Agriculture, Natural Resources Conservation Services, Soils. [https://www.nrcs.usda.gov/wps/portal/nrcs/detail/soils/edu/?cid=nrcs142p2\\_054286#:~:text=Munsell%20Color%20System&text=The%20Munsell%20System%20allows%20for,in%20books%20of%20color%20chips](https://www.nrcs.usda.gov/wps/portal/nrcs/detail/soils/edu/?cid=nrcs142p2_054286#:~:text=Munsell%20Color%20System&text=The%20Munsell%20System%20allows%20for,in%20books%20of%20color%20chips). (last visited March 15, 2022). The U.S. Dept. of Transportation, Federal Highway Administration Reference Manual the Agency’s Recommendation states that the Munsell Color System may be required for soil description. Attachment E to Agency’s Rec, Sec. 4.1.3.

<sup>6</sup> IPCB, February 4, 2022, pg. 21.

March 21, 2022

---

the chlorides detected in the groundwater are not from CCR, but instead are “likely moving from the road salts...” and infiltrating the groundwater.<sup>7</sup> She further states that the chlorides “are exhibiting the recharge that is occurring at the site through the surface into the immediate groundwater through a material with a high hydraulic conductivity providing a rapid infiltration rate on the order of less than a week”<sup>8</sup>. Ms. Martin appears to be suggesting that the chlorides in the groundwater demonstrate that there is a high hydraulic conductivity in the soils surrounding Pond 2.<sup>9</sup> She appears to conclude that the high hydraulic conductivity demonstrates that the materials in Pond 2’s embankment is CCR, with the potential to leach metals to the groundwater, because the black silty gravel has a higher hydraulic conductivity than the surrounding clay.<sup>10</sup>

For the reasons presented below, the contaminant transport mechanisms and the role of the supposed high hydraulic conductivity within the Pond 2 embankment and the Pond 2 monitoring wells described by Ms. Martin are not correct. The physical configuration of the topography along the highway bordering Pond 2 does not allow impacted storm water from the highway to flow over the ground, reach the topsoil of the Pond 2 embankment and then migrate vertically to the underlying groundwater through the Pond 2 embankment material. Instead, the chloride-impacted groundwater migrates onto MWG property after entering the aquifer closer to the highway. Similarly, it is not possible for chloride-impacted storm water from the highway to reach the Pond 2 groundwater monitoring wells “on the order of less than a week”, as indicated in the Illinois EPA Recommendation. Rather, from the time the highway runoff enters the uppermost aquifer, it will take a minimum of 30 days to reach the upgradient well (MW-10), but more than 200 days to reach the downgradient wells (MW-3/4/5).

The surface topography between the highway and Pond 2 does not allow for storm water to flow into the topsoil of the Pond 2 embankment. For storm water from the highway to “impact the topsoil of the Pond 2 embankment”, the chloride-impacted storm water from the highway would need to flow over the land from the highway right-of-way, onto MWG property and to the Pond 2 embankment, where it could percolate into the upper soils next to the Pond. However, the surface topography along the highway is contoured to collect storm water in a ditch along the south side of the road (between the road and MWG property). The storm water ditch is visible on the ground surface profile generated by Google Earth from U.S. Highway 6, south through Pond 2 and to the Des Plaines River and is approximately two feet deep

---

<sup>7</sup> IPCB, February 4, 2022, Exhibit A, Paragraph 35.

<sup>8</sup> IPCB, February 4, 2022, Exhibit A, paragraph 37.

<sup>9</sup> IPCB, February 4, 2022, Exhibit A, paragraph 37.

<sup>10</sup> IPCB, February 4, 2022, Exhibit A, paragraph 38.

(see **Exhibit B** attached). The ditch does not allow for overland flow of storm water from the highway to the immediate vicinity of the Pond 2 embankment.

Rather than travel over the land onto MWG property, storm water that contains chlorides from the road salt flows from the highway, to the shoulder of the road and into the drainage ditch. Gravity causes a portion of the storm water to percolate vertically through the soil, encountering the uppermost aquifer closer to the highway and before migrating onto MWG's property. In other words, the storm water flows off of the highway then flows down (vertically) into the groundwater. **Exhibit B** attached includes a demonstrative drawing of the storm water flow. The other portion of the storm water flows within the drainage ditch away from the immediate vicinity of Pond 2, parallel to the highway.

According to the historical hydrogeological investigation report prepared for the Joliet 29 Station,<sup>11</sup> the uppermost aquifer is located approximately 30 feet below the bottom of the storm water ditch. Once the storm water containing dissolved chloride reaches the aquifer, it flows downgradient (generally towards the MWG site/Des Plaines River) at a maximum velocity equivalent to the rate of groundwater flow. According to historical groundwater monitoring reports prepared pursuant to the Federal CCR Rules (40 CFR Part 257), the groundwater seepage velocity within the uppermost aquifer at the Joliet 29 Station ranges from 0.26 ft/day to 4.16 ft/day, with an average of 0.87 ft/day.<sup>12</sup> Using the average seepage velocity (and making the conservative assumption that the dissolved chloride will flow at the same velocity as the groundwater),<sup>13</sup> it takes approximately 30 days for the storm water that mixes with the groundwater below the ditch to reach MW-10. Similarly, it takes at least 300 days for the storm water that mixes with the groundwater below the ditch to reach downgradient wells MW-3 and MW-4, and 210 days to reach MW-5.

Ms. Martin's analysis of historic precipitation records<sup>14</sup> to support her conclusion is also fundamentally flawed for a number of reasons. Despite having data for over ten years, and thus having at least 10 spring groundwater sampling events (following road salt application during fall/winter), she only reviewed historic precipitation records preceding two sampling events – 2018 and 2019. A review of the spring sampling events from 2010 to present shows that the concentrations of chlorides is usually higher in the spring. But, as described in the paragraphs above, that does not support the conclusion that high hydraulic conductivity in select soil units around Pond 2 is causing storm water from the highway to rapidly

---

<sup>11</sup> Patrick Engineering, 2011.

<sup>12</sup> KPRG, January 31, 2022a.

<sup>13</sup> Dissolved constituents typically travel in groundwater at a slower rate than the groundwater velocity, so the fastest possible migration rate is at the same seepage velocity as the groundwater.

<sup>14</sup> IPCG, Exhibit A, Paragraph 36.

infiltrate within the pond embankment, which is subsequently resulting in leaching of CCR constituents to the groundwater. The seepage velocity assessment presented above indicates more of a time lag between the storm water infiltration (occurring at the highway) and the chloride appearing at the Pond 2 monitoring wells.

Similarly, Ms. Martin relies upon the one groundwater sampling event only after a rain event, to conclude that the soil has high hydraulic conductivity, resulting in extremely rapid recharge, which is ultimately resulting in leaching of CCR. But that is an invalid analysis because there are no samples of the groundwater immediately before the precipitation event (sampling only occurs quarterly, so the closest sampling points in time to the spring precipitation events cited by Ms. Martin are from the 4<sup>th</sup> quarter of the preceding year). Without an analysis of the groundwater immediately before a precipitation event, no conclusions can be made about the rate of recharge and its connection to the leaching of CCR constituents to the groundwater.

### **Evaluation of Joliet 29 CCR as a Possible Source of Cobalt at MW-4**

With regard to cobalt concentrations at monitoring wells around Pond 2, Illinois EPA has contended within Exhibit A of the Illinois EPA Recommendation that:

- The presence of total cobalt at certain monitoring wells downgradient of Pond 2 is indicative of CCR impacts; and
- Reporting of groundwater quality results collected since Part 845 became effective (in May 2021 and August 2021) are not representative of the aquifer due to “data quality issues” associated with dissolved or field filtered samples vs. total (unfiltered) samples and sampling methods used.

The following information is presented in response to the above points made by Illinois EPA.

Other than chloride (which is recognized as attributable to impacts from road salt), cobalt is the only groundwater monitoring constituent historically detected at MW-4 at concentrations exceeding the 35 IAC 845.600(a)(1) GWPS. Cobalt is not found at downgradient monitoring wells MW-3 or MW-5 at concentrations above the GWPS.

Moreover, constituents commonly found in CCR-impacted groundwater have never been reported in the groundwater in MW-3, MW-4, and MW-5 at concentrations exceeding the above GWPS, including common CCR indicator parameters: boron, calcium, fluoride, pH, or sulfate. See Hazardous and Solid Waste Management System; Disposal of Coal Combustion Residuals from Electric Utilities, 80 Fed. Reg. 21342 (April 17, 2-15) (USEPA identified boron, calcium, fluoride, pH, and sulfate as known to be leading indicators of releases of contaminants associated with CCR).

March 21, 2022

---

In my professional career comprising over 25 years of experience involving groundwater monitoring programs at CCR facilities, boron is by far the most common constituent identified in groundwater in documented cases where CCR has impacted groundwater. The absence of boron in the groundwater around Pond 2 at concentrations exceeding the GWPS is the single most important factor in an evaluation of whether data from monitoring well MW-4 is indicative of impacts related to CCR.

While common CCR indicator parameters have never been detected in the groundwater at concentrations exceeding the above GWPS in the monitoring wells downgradient of Pond 2, there are other less common constituents that also may be associated with CCR. These include: antimony, arsenic, barium, chromium, beryllium, cadmium, lead, lithium, mercury, molybdenum, selenium, and thallium. None of these metals have been detected in the groundwater at Pond 2 at concentrations exceeding the GWPS during the historical groundwater monitoring program, which dates back over 10 years, to the 4<sup>th</sup> quarter of 2010.

To further demonstrate the absence of groundwater impacts from CCR at Pond 2, I reviewed the Federal CCR Compliance, Annual Groundwater Monitoring and Corrective Action Report – 2021 for the Lincoln Stone Quarry at the MWG Joliet 9 Station, dated January 31, 2022.<sup>15</sup> The Lincoln Stone Quarry is located across the Des Plaines River from the MWG Joliet 29 Station and received CCR produced at the Joliet 29 Station for disposal, pursuant to a landfill permit issued by Illinois EPA, including the CCR historically managed in Pond 2. This unit is undergoing Assessment Groundwater Monitoring under the Federal CCR Rules and is also in the process of selecting a remedy to address groundwater impacts in accordance with 40 CFR 257.<sup>16</sup> According to the above groundwater monitoring report, boron was present at 9 of 10 monitoring wells exhibiting statistically significant increases in the CCR groundwater monitoring network and 7 of 8 monitoring wells in the expanded assessment groundwater monitoring network.<sup>17</sup> If CCR had been used as fill at Joliet 29 and leaching was occurring from the fill, the groundwater would exhibit similar concentrations of boron as seen at the Lincoln Stone Quarry.

Additional information supporting the importance of boron as a CCR indicator parameter in groundwater is found within the Application for Initial Operating Permit, Joliet #9 Generating Station, dated October 29, 2021.<sup>18</sup> This permit application (for the Lincoln Stone Quarry) included analytical data from a leachate piezometer (P105) collected to support subsequent numerical groundwater modeling associated with the Groundwater Impact Assessment (GIA) and landfill operating permit renewal. As stated above, the Lincoln Stone Quarry received CCR material produced at the Joliet 29 Station and managed within Pond 2 (i.e.,

---

<sup>15</sup> KPRG, January 31, 2022a.

<sup>16</sup> KPRG, January 31, 2022a

<sup>17</sup> KPRG, January 31, 2022a

<sup>18</sup> KPRG, October 29, 2021.

CCR managed in Pond 2 was ultimately transferred to the Lincoln Stone Quarry). To the extent that any CCR is found outside the Pond 2 HDPE liner as alleged by Illinois EPA, this would also be the same CCR. The leachate from the Lincoln Stone Quarry was sampled from piezometer P105 on a quarterly basis in 2012. The analytical results from all four quarters exhibited boron concentrations, ranging from 10 mg/L to 12 mg/L (consistently greater than the 35 IAC 845 GWPS of 2.0 mg/L). Not only was boron detected in all four samples, but arsenic was detected in 3 of 4 samples and barium was detected in 4 of 4 samples. Presumably, because cobalt is not a typical CCR indicator parameter, it was not included in the list of constituents analyzed in this leachate. As mentioned above, the absence of boron, arsenic, and barium in the groundwater around Pond 2 above the GWPS, compared to the presence of the same metals in known leachate from Joliet 29 CCR demonstrates that the groundwater at Pond 2 is not impacted by Joliet 29 CCR.

If CCR was the source of the cobalt detected in the groundwater at MW-4, the overall groundwater quality signature would be more indicative of CCR. Namely, at least one or more other constituents commonly attributed to the CCR that was managed at Pond 2 and allegedly located outside the existing Pond 2 HDPE liner would be identified at least occasionally within the groundwater at concentrations exceeding the GWPS.

#### **Alternate Source for Cobalt at MW-4**

Because of the absence of common CCR constituents in the groundwater, I investigated other potential sources of the cobalt in MW-4. Cobalt is a naturally occurring metal, and its presence in MW-4 is more likely than not due to the chlorides from the road salt, which displaces natural metals in soils.

Cobalt is a well-documented naturally occurring constituent observed at concentrations in background soils within Illinois. In particular, the 35 IAC 742 TACO regulations indicate in Appendix A, Table G, Concentrations of Inorganic Chemicals in Background Soils that the cobalt concentration in background soils is 8.9 mg/kg (parts per million, or ppm) in Counties Within Metropolitan Statistical Areas (which includes Will County). This background concentration may be utilized as an alternative soil remediation objective for any exposure route under the TACO program.

Additionally, the Inorganic Chemical Composition of Illinois Soils by Richard Cahill ("Illinois Soils Composition") shows that cobalt is documented to be a natural component of native soils in Illinois<sup>19</sup> and within Will County, in particular. The Illinois Soils Composition is a compendium of chemical composition

---

<sup>19</sup> Cahill, Richard A., 2017. Inorganic Chemical Composition of Illinois Soils, Illinois State Geological Survey Circular 590.

studies of metals in Illinois soils. The studies discussed include a collection of 318 soil cores and an analysis of 1,272 samples of Illinois soils.<sup>20</sup> A copy of the Cahill, 2017 technical reference is contained in **Exhibit C** attached.

The first study cited in Illinois Soils Composition was performed by Zhang and Frost<sup>21</sup>, with data collection beginning in 1992. That study indicated that cobalt was detected above the laboratory reporting limits in 90 of 90 soil samples from around the state, in both the A and B soil horizons. For reference, the A soil horizon is considered the topsoil layer found immediately beneath the ground surface (generally ranging in thickness from 6 – 12 inches), while the B horizon is the layer beneath the A horizon (generally ranging in thickness from 1 – 2 feet). Within the A soil horizon, the mean concentration of cobalt was 10.7 mg/kg (ppm), with a minimum of 2.8 and maximum of 21.0 mg/kg (ppm). Within the B soil horizon, the mean concentration of cobalt was 11.5 mg/kg (ppm), with a minimum of 2.6 and maximum of 20.0 mg/kg (ppm)<sup>22</sup>.

Another study cited in Illinois Soils Composition was performed by the United States Geological Survey (USGS) in 2013.<sup>23</sup> The USGS deemed there was a critical need to create a dataset concerning the concentrations and spatial distribution of naturally occurring elements in soils of the United States. Soil samples were collected on a random grid in the most representative geomorphic setting of the target area. Importantly, obvious contaminated areas were avoided, including proximity to highways, buildings, and active major industrial areas. This study included sampling of 88 locations in Illinois, including a sample in Will County. The sample from Will County was collected from land use identified as “Grasslands/herbaceous”.<sup>24</sup> The data from this study reported concentrations of cobalt in Will County soils from approximately the upper 6” to a depth of 1 ft. at concentrations ranging from 6.9 to 10.9 mg/kg (ppm).<sup>25</sup> These concentrations are similar to the background concentrations cited in the TACO regulation and the results from the 1992 study discussed above.

For reference, the maximum concentration of cobalt in groundwater at MW-4 since 2015 (on a total/unfiltered basis) has been reported as 0.016 mg/L (or ppm), which is multiple orders of magnitude lower than the background concentration in local soils. Thus, it would only take a small fraction of the

---

<sup>20</sup> Cahill, 2017, pg. 7 of 156 in electronic .pdf document.

<sup>21</sup> Cahill, 2017, pg. 7 of 156 in electronic .pdf document.

<sup>22</sup> Cahill, 2017, Table 1, pg. 10 of 156 in electronic .pdf document.

<sup>23</sup> Cahill, 2017, pg. 17 of 156 in electronic .pdf document.

<sup>24</sup> Cahill, 2007, pg. 113 of 156 in electronic .pdf document.

<sup>25</sup> Cahill, 2017, pg. 128 of 156 in electronic .pdf document.

natural cobalt present in background soil to leach into the groundwater to result in the groundwater concentrations historically observed at MW-4.

Based upon the attached 2018 study, “A Review of the Combined Threats of Road Salts and Heavy Metals to Freshwater Systems,” by Matthew S. Schuler and Rick A. Relyea (“Schuler Study”) the natural cobalt present in local soils is being mobilized into the groundwater unit monitored at Pond 2 in association with the same groundwater impacts to chloride documented from the use of road salt on the adjacent U.S. Highway 6. A description of the phenomena resulting in the mobilization of cobalt from the background soils into the uppermost aquifer is presented here and the study is attached.”<sup>26</sup>(see **Exhibit D**).

As explained in the Schuler Study, heavy metals contained in roadside soils are usually bound within the soils, but can be mobilized by road salts, including sodium chloride, magnesium chloride, and calcium chloride. The application of roadway salts can release heavy metals associated with organic soils through several interrelated mechanisms. Specifically, road salts can increase the distribution of heavy metals by disrupting soil structure, changing soil chemistry, and altering ion exchange.<sup>27</sup>

High concentrations of sodium can displace calcium and magnesium in soil, thereby disrupting soil structure. This process is particularly common when high concentrations of salty runoff are followed by large flows of low-electrolyte water (with fewer dissolved ions) into sodium-rich soils. For example, this may occur when large quantities of salt are applied to the roadway in winter, followed by heavy liquid precipitation events. This results in increased porosity of the soil, which increases mobilization of metals contained in natural soils and their associated compounds.<sup>28</sup>

Studies cited in the Schuler Study showed that in organic soils, aqueous complex compounds (ligands) will reduce the adsorption of certain metals, which increases the potential for mobilization by chloride complexes. As metals are desorbed (disconnected from soil) and transformed into a soluble phase, chloride complexes can increase the solubility of metals.<sup>29</sup>

Additionally, road salts can directly displace metals bound to soil without affecting soil structure. The binding affinity of many organic compounds is higher for sodium, calcium, and magnesium than it is for most heavy metals. The introduction of higher concentrations of sodium, calcium, and/or magnesium cations from road salts reduce binding affinities for heavy metals and consequently displace heavy metals that would otherwise remain bound in the soil. While sodium chloride is the most commonly used

---

<sup>26</sup> Schuler and Relyea, 2018.

<sup>27</sup> Schuler and Relyea, 2018, pg. 330.

<sup>28</sup> Schuler and Relyea, 2018, pg. 330.

<sup>29</sup> Schuler and Relyea, 2018, pg. 330.



roadway salt (a/k/a “rock salt”), magnesium chloride and calcium chloride salts are also used for road salt applications.<sup>30</sup> The magnesium and calcium products are more effective at ion exchange and therefore have a greater impact on heavy metal mobilization through ion displacement, compared to sodium.<sup>31</sup>

According to a 2004 study relied upon by the Schuler Study, the majority of the mobilization of heavy metals by roadway salts is likely due to ion exchange, rather than changes to soil structure or pH.<sup>32</sup> Certain metals are more prone to ion exchange, and the Schuler Study specifically identifies cobalt as more easily mobilized by ion exchange.<sup>33</sup>

In summary, the cobalt detected in the groundwater at the Pond 2 groundwater monitoring network is from naturally occurring cobalt known to be present in local soils. The cobalt is mobilized by road salt applied to U.S. Highway 6 and subsequently leached into the groundwater, where it migrates in the uppermost aquifer downgradient, toward the Pond 2 groundwater monitoring network.

### **Alleged Data Quality Issues with Total Vs. Dissolved Groundwater Data**

I have worked my entire professional career in Illinois and have extensive experience in implementing various groundwater monitoring programs, including solid and hazardous waste landfills, as well as CCR units. The collection of both total and dissolved groundwater monitoring data is more common in Illinois than other states where I have worked. This practice is particularly common for metals. Various regulations and permits for Illinois disposal facilities require the collection of both total metals (i.e., from an unfiltered sample) and dissolved metals (i.e., from a sample filtered in the field as the sample is collected).

While the total metals concentrations in groundwater are usually higher than dissolved metals concentrations from the same sample, as is the case with application of most theoretical scientific principles, in practice it is unreasonable and not scientifically sound to expect that the total metals concentrations will be higher than dissolved metals 100% of the time. This is due primarily to irregularities within the standard laboratory analytical methods approved by the United States Environmental Protection Agency (USEPA) for laboratory analysis of metals. Essentially, the quality assurance/quality control standards governing the laboratory analytical methods allow for certain variances in calibration of

---

<sup>30</sup> The City of Joliet uses rock salt on its roads. See City of Joliet, Legislative Text, Award of Contract for the Rock Salt Purchase 2021-2022, <https://www.joliet.gov/Home/Components/RFP/RFP/4342/> (Recommendation to purchase 10,000 tons of rock salt).

<sup>31</sup> Schuler and Relyea, 2018, pg. 330-331.

<sup>32</sup> Schuler and Relyea, 2018, pg. 331, *citing* Bäckström M, Karlsson S, Bäckman L, Folkesson L, Lind B. 2004. Mobilisation of heavy metals by deicing salts in a roadside environment. *Water Research* 38: 720–732.

<sup>33</sup> Schuler and Relyea, 2018, pg. 331.

March 21, 2022

---

the known standards, which can result in certain variations in reporting of the data. As long as the calibration data are documented to be within a certain range of accuracy and precision acceptance criteria, the results can be certified by the laboratory as performed in accordance with the standard USEPA-approved methods.

Typically, the total and dissolved groundwater sample analysis will be performed on two separate containers collected consecutively in the field (one filtered and one unfiltered), as quickly as the samplers can reasonably collect the samples. However, because groundwater is constantly moving, concentrations of metals in groundwater are continuously changing and it is possible for some slight variation to occur, even in groundwater samples collected immediately after each other. Additionally, when the concentrations detected of a chemical are miniscule, such as on the order of parts per billion (ppb), the variation in results also increases, simply due to the low concentrations.

Illinois EPA has cited a concern with the total vs. dissolved metals reported during groundwater sampling events occurring in May and August of 2021.<sup>34</sup> In response, I have performed a side-by-side comparison of reported total and dissolved results for the metals exhibiting concentrations reported above the laboratory reporting limit in at least one sample during the two sampling events referenced above. Specifically, the analytical results were reviewed for barium, boron, cobalt, and selenium. Out of a total of 32 results for metals analyzed for both total and dissolved metals from MW-10, MW-3, MW-4, and MW-5 during these two sampling events, only 4 results exhibited concentrations of dissolved metals greater than total metals (two during the May 2021 event and two during the August 2021 event). The four were for barium (2), boron, and cobalt, and they were each below the Illinois CCR Rule GWPS. If there had been quality-control issues upon collection, the concentrations of the other dissolved metals collected would also have been above the total metals for other metals. Also, because the concentrations of cobalt are in the ppb range, it is to be expected that occasionally the total concentrations may not consistently be above the dissolved metal concentrations or it is simply a difference in rounding. For example, in MW-5, on August 30, 2021 the dissolved barium was 0.07 mg/l and the total barium was 0.069 mg/l. A 0.001 mg/l difference in results is not significant. In WCG's experience in the industry, when dealing with large data sets, a small number of results with dissolved metals concentrations greater than the total metals is typical and not indicative of data quality issues.

---

<sup>34</sup> IPCB, February 4, 2022, Exhibit A, paragraph 40.

## Summary of Conclusions

The technical analysis and opinions contained herein are being provided in response to the RECOMMENDATION OF THE ILLIONIS ENVIORNMENTAL PROTECTION AGENCY, filed before the Illinois Pollution Control Board on February 4 2022 pertaining to the Petition of Midwest Generation for an Adjusted Standard, Joliet 29 Station, AS 2021-001.

In response to the conclusions presented in the Illinois EPA Recommendation concerning the above subjects, WCG provides the following summary of our rebuttal opinions/conclusions:

- Economic quantities of darker fill soils are available from the area of the Joliet 29 Station, as supported by the prior WCG Phase II ESA at a site within 1.5 miles of the Joliet 29 Station. The information collected from this local site, combined with the information presented below, indicates that the “black silty gravel” material reported to be contained within portions of the Pond 2 embankments is not CCR.
- The physical configuration of the topography along the highway bordering Pond 2 does not allow road salt impacted storm water from the highway to reach the topsoil of the Pond 2 embankment and then be leached to the underlying groundwater through the Pond 2 embankment material. Instead, the chloride-impacted groundwater migrates onto MWG property after entering the aquifer closer to the highway.
- It is not possible for chloride-impacted storm water from U.S. Highway 6 to reach the Pond 2 groundwater monitoring wells “on the order of less than a week”, as indicated in the Illinois EPA Recommendation. Rather, it will take a minimum of 30 days to reach the upgradient well, and more than 200 days to reach the downgradient wells.
- Because each of Ms. Martin’s conclusions about the chloride and topography are incorrect, the chloride and limited precipitation data cited in her affidavit do not support her conclusion that the high hydraulic conductivity is causing the road salt impacts from the highway to rapidly migrate through the soil around Pond 2, and therefore indicating that the groundwater is impacted by CCR constituents.
- If CCR was the source of the cobalt detected in the groundwater at MW-4, the overall groundwater quality signature would be more indicative of CCR. Namely, at least one or more other constituents commonly attributed to the CCR that was managed at Pond 2 and allegedly located outside the existing Pond 2 HDPE liner would be identified at least occasionally within the groundwater at concentrations exceeding the GWPS.
- Because of the absence of the other CCR constituents, particularly the constituents commonly associated with CCR, the cobalt detected in MW-4 is from naturally occurring cobalt known to be

March 21, 2022

---

present in local soils. The cobalt is mobilized by road salt applied to U.S. Highway 6 and subsequently leached into the groundwater, where it migrates in the uppermost aquifer downgradient, toward the Pond 2 groundwater monitoring network.

- There are no significant data quality issues with the total and dissolved metals analytical results reported in the groundwater monitoring data from Pond 2.



Michael B. Maxwell, LPG  
Weaver Consultants Group  
Chicago EPG Operations Manager

List of Attachments/Appendices:

- |            |  |
|------------|--|
| Exhibit A: | References   |
| Exhibit B: | Google Earth Profile From U.S. Highway 6 onto MWG Property   |
| Exhibit C: | Cahill, 2017, Inorganic Chemical Composition of Illinois Soils   |
| Exhibit D: | Schuler and Relyea, 2018, A Review of the Combined Threats of Road Salts and Heavy Metals to Freshwater System |

**EXHIBIT A**

**References**

Cahill, Richard A., 2017. Inorganic Chemical Composition of Illinois Soils, Illinois State Geological Survey Circular 590.

Illinois Pollution Control Board (IPCB), February 4, 2022, Recommendation of the Illinois Environmental Protection Agency, In The Matter Of: Petition of Midwest Generation for an Adjusted Standard From 845.740(a) and Finding of Inapplicability of Part 845 (Joliet 29 Station), AS 2021-001.

KPRG and Associates, Inc., August 18, 2005. CCB Determination Summary Report, Joliet, Illinois.

KPRG and Associates, Inc., October 29, 2021. Application for Initial Operating Permit, Joliet #9 Generating Station, Midwest Generation, LLC, Joliet, Illinois.

KPRG and Associates, Inc., January 31, 2022. Federal CCR Compliance, Annual Groundwater Monitoring and Corrective Action Report – 2021, Midwest Generation, LLC, Joliet #9 Generating Station, 1601 South Patterson Road, Joliet, Illinois.

KPRG and Associates, Inc. January 31, 2022. Federal CCR Compliance, Annual Groundwater Monitoring and Corrective Action Report – 2021, Midwest Generation, LLC, Joliet #29 Generating Station, Joliet, Illinois.

Patrick Engineering, Inc., February 2011. Hydrogeologic Assessment Report, Joliet Generating Station.

Schuler, M.S. and Relyea, R.A., May 2018, Vol. 68 No. 5, in BioScience, A Review of the Combined Threats of Road Salts and Heavy Metals to Freshwater Systems.

35 Illinois Administrative Code, Part 742.

35 Illinois Administrative Code, Part 845.

**EXHIBIT B**

**Google Earth Profile From U.S. Highway 6 onto MWG Property**



# Electronic Filing: Received, Clerk's Office 3/24/2022

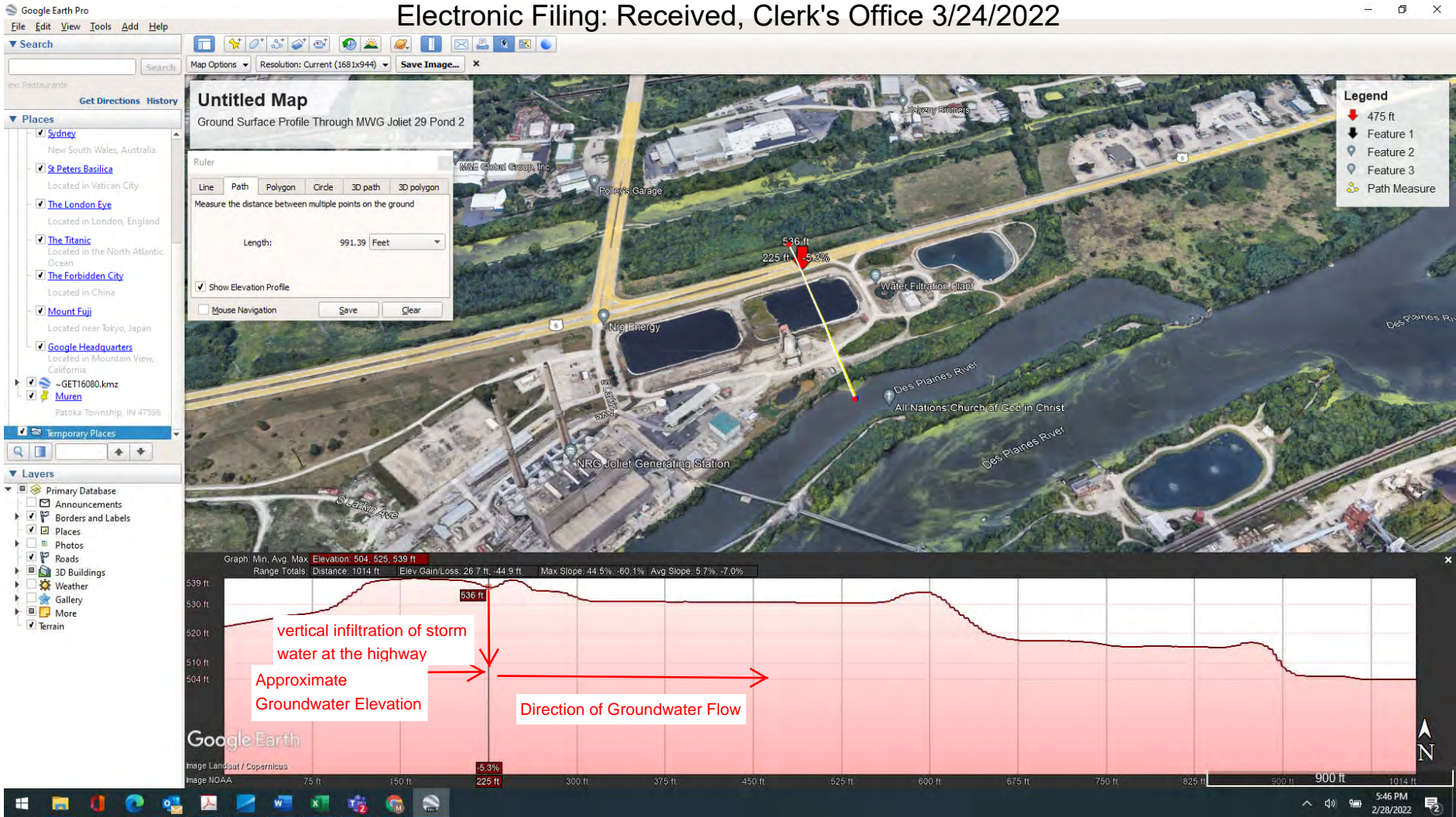

**EXHIBIT C**

**Cahill, 2017**

**Inorganic Chemical Composition of Illinois Soils**



# Inorganic Chemical Composition of Illinois Soils

Richard A. Cahill

Illinois State Geological Survey, Prairie Research Institute, University of Illinois  
at Urbana-Champaign



**Circular 590 2017**

**ILLINOIS STATE GEOLOGICAL SURVEY**  
Prairie Research Institute  
University of Illinois at Urbana-Champaign

**I ILLINOIS**  
Illinois State Geological Survey  
PRAIRIE RESEARCH INSTITUTE

## Electronic Filing: Received, Clerk's Office 3/24/2022

**Front cover:** *Circa 1940s aerial photograph of the Cruse Farm, now part of the University of Illinois South Farms. The view is looking north, and U.S. Route 45 is on the left. The Abbott Power Plant can be seen in the distance. This area is part of the 1,000 acres of research fields where research in soil fertility and crop production has taken place since 1904. In 2015, part of this area became the University of Illinois Solar Farm, the largest solar array installed on a Big Ten University campus.*

# Inorganic Chemical Composition of Illinois Soils

Richard A. Cahill

Illinois State Geological Survey, Prairie Research Institute, University of Illinois  
at Urbana-Champaign

**Circular 590 2017**

**ILLINOIS STATE GEOLOGICAL SURVEY**

Prairie Research Institute  
University of Illinois at Urbana-Champaign  
615 E. Peabody Drive  
Champaign, Illinois 61820-6918  
<http://www.isgs.illinois.edu>

**I ILLINOIS**

Illinois State Geological Survey  
PRAIRIE RESEARCH INSTITUTE

## **ACKNOWLEDGMENTS**

Joyce Frost, who coauthored the first report on Illinois soils cited here, urged me to prepare a document that reported the analytical chemistry results in tabular form. Her study began in 1991 and was suspended in 1994. It was supported by the Illinois Department of Transportation through the Environmental Site Assessments Section of the Illinois State Geological Survey (ISGS), then headed by Nicholas Schneider. Leon Follmer was coauthor of the second report on Illinois soils used here. He encouraged me to combine the series of seven progress reports describing the geology and chemical composition of soils into a single document that would contain the analytical chemistry results. That project was supported entirely with ISGS funds.

This report benefited from thoughtful review comments provided by William Roy, Ivan Krapac, and David Grimley of the ISGS and Roger Windhorn of the U.S. Department of Agriculture, Natural Resources Conservation Service. The following staff from the ISGS provided encouragement to pursue this effort: Randy Locke, Christopher Stohr, Andrew Phillips, and James Miner. Curtis Abert, Morgan Bailey, Ronald Klass, Michael Knapp, Susan Krusemark, and Alison Lecouris provided technical assistance in the completion of this manuscript.

### **Suggested citation:**

Cahill, R.A., 2017, Inorganic chemical composition of Illinois soils: Illinois State Geological Survey, Circular 590, 148 p.

**CONTENTS**

<b>Acknowledgments</b>	ii
<b>Abbreviations</b>	iv
<b>Abstract</b>	1
<b>Introduction</b>	1
<b>Methods and Results</b>	1
Illinois Department of Transportation-Sponsored Background Illinois Soils (Zhang and Frost 2002)	1
Statewide Soil Collection (Dreher and Follmer Series)	3
<b>Discussion</b>	5
<b>Summary</b>	14
<b>References</b>	15
<b>Appendixes</b>	17
1 Analysis Number, County, Location, Field Identification, Depth, and Elemental Concentrations in Illinois Soils (Zhang and Frost 2002)	17
2 API Number, Core Identification, County, Soil Type, Location, Elevation, Depth of Core, Date Collected, and Number of Subsamples (Dreher and Follmer Series)	37
3 Core Identification, County, Soil Texture, Soil Type, Soil Association, and Land Use (Dreher and Follmer Series)	41
4 Sample Identification; County; Depth Interval; Horizon; Sand, Silt, and Clay Concentrations; and Soil Texture (Dreher and Follmer Series)	45
5 Laboratory Number, Sample Identification, County, Horizon, Depth Interval, Elemental Concentrations, and pH (Dreher and Follmer Series)	59
6 Laboratory Number, Site Identification, County, Depth Interval, Location, Land Cover, Land Use, and Elemental Concentrations (Smith et al. 2013)	103
7 Box and Whisker Plots of Concentrations of Various Elements and Compounds in Illinois Soils (Zhang and Frost 2002; Dreher and Follmer Series; Smith et al. 2013)	139
<b>Tables</b>	
1 Mean, range, and number of samples above the detection limits (DL) in the A and B horizons of Illinois soils	4
2 Quality assurance/quality control results relative to NIST SRM 2709 by X-ray fluorescence spectrometry analyzed during the first 2 years of the project	6
3 Quality assurance/quality control results for Hg analysis in four reference materials	6
4 Mean, range, detection limits (DL), and number of samples above the DL in all samples and in the A horizon of Illinois soils	7
5 Mean, range, and number of samples above the detection limits (DL) in the B and C horizons of Illinois soils	8
6 Comparison of mean, median, range, and lower and upper quartile concentrations of major elements in the uppermost intervals of soil cores	9
7 Comparison of mean, median, range, and lower and upper quartile concentrations of trace elements in the uppermost intervals of soil cores	10
8 Lower limits of detection (LLD), mean, range, and number of samples above the detection limits (DL) in the surface, A horizon, and C horizon of Illinois soils	12
9 Combined results of the mean, range, and number of samples above the detection limits (DL) in the A horizon of Illinois soils	13
10 Mean, median, and range of Ba, Cd, Rb, and Zn concentrations in Illinois soils	14
11 Mean, median, and range of elemental concentrations in Illinois soils	14
<b>Figures</b>	
1 Elements reported in this study	2
2 Site locations of soil samples collected in 1992 (Zhang and Frost 2002)	3
3 Core locations and years the soil cores were collected for the Dreher and Follmer Series (Dreher et al. 2002, 2003a, 2003b; Dreher and Follmer 2004a, 2004b, 2004c, 2005)	5
4 Core locations of Illinois soils sampled by the U.S. Geological Survey (Smith et al. 2013)	11

**ABBREVIATIONS****Chemical Elements**

Ag	silver
Al	aluminum
As	arsenic
B	boron
Ba	barium
Be	beryllium
Bi	bismuth
Br	bromine
C	carbon
Ca	calcium
Cd	cadmium
Ce	cerium
Co	cobalt
Cr	chromium
Cs	cesium
Cu	copper
Dy	dysprosium
Eu	europium
Fe	iron
Ga	gallium
Hf	hafnium
Hg	mercury
In	indium
La	lanthanum
Li	lithium
Lu	lutetium
K	potassium
Mg	magnesium
Mn	manganese
Mo	molybdenum
Na	sodium
Nb	niobium
Ni	nickel
P	phosphorus
Pb	lead
Rb	rubidium
S	sulfur
Sb	antimony
Sc	scandium
Se	selenium
Si	silicon
Sm	samarium
Sn	tin
Sr	strontium
Ta	tantalum
Tb	terbium
Te	tellurium
Th	thorium

**Chemical Elements** *Continued*

Ti	titanium
Tl	thallium
U	uranium
V	vanadium
W	tungsten
Y	yttrium
Yb	ytterbium
Zn	zinc
Zr	zirconium

**Chemical Compounds**

Al <sub>2</sub> O <sub>3</sub>	aluminum oxide
CaO	calcium oxide
CO <sub>2</sub>	carbon dioxide
Fe <sub>2</sub> O <sub>3</sub>	iron oxide
K <sub>2</sub> O	potassium oxide
MgO	magnesium oxide
MnO	manganese oxide
Na <sub>2</sub> O	sodium oxide
P <sub>2</sub> O <sub>5</sub>	phosphorus pentoxide
SO <sub>3</sub>	sulfur trioxide
SiO <sub>2</sub>	silicon dioxide
TiO <sub>2</sub>	titanium dioxide

**Units of Measure**

cm	centimeter
in.	inch
km	kilometer
m	meter
mg/kg	milligrams per kilogram
µg/kg	micrograms per kilogram

**Other**

AA	atomic absorption
API	American Petroleum Institute
CVAA	cold-vapor atomic absorption
DL	detection limit
GPS	global positioning system
ID	identification
IEPA	Illinois Environmental Protection Agency
INAA	instrumental neutron activation analysis
ISGS	Illinois State Geological Survey
n	number of determinations
NIST SRM	National Institute of Standards & Technology Standard Reference Material
OES	optical emission spectrography
QA/QC	quality assurance/quality control
USGS	U.S. Geological Survey
XRF	X-ray fluorescence



## ABSTRACT

The Illinois State Geological Survey completed two surveys of Illinois soils between 1998 and 2005. In neither of these studies were tabular results published that showed the concentrations of a comprehensive suite of elements in Illinois soils. In 2013, the U.S. Geological Survey reported geochemical data for soils throughout the United States, and the results of that study as well as samples from the major soil horizons in Illinois are included in this report. The present report includes the upper 0- to 5-cm interval as well as samples from the major soil horizons. A number of different analytical techniques were used in these studies and quality assurance/quality control results are included.

In the three studies, 318 cores were collected and 1,272 samples of Illinois soils were analyzed. Summary tables and tabular data are provided. This report is intended as a reference source for values that can be used to evaluate soil quality data collected for environmental and agricultural investigations. No attempt was made to discuss geochemical associations of the elements or to plot the results to establish regional trends. The purpose is to provide data in tabular form to use in other investigations involving soil constituents and their concentrations.

## INTRODUCTION

Soil is a natural body composed of solids (minerals and organic matter), liquids, and gases that occurs on the land surface and beneath shallow water. Soil is characterized by horizons, or layers, that are distinguishable from the parent material and that have the ability to support rooted plants. The upper limit of soil is the boundary between the soil and air. The lower boundary that separates soil from the nonsoil underneath is more difficult to define. Commonly, soil is transitional at its lower boundary, with intact hard rock, weathered regolith, or glacial till materials that are devoid of animals, roots, or other marks of biological activity. For purposes of classification, the lower boundary of soil is often set at 200 cm (Soil Survey Staff 1999).

In addition to supporting human life by providing fiber, food, and wood, soils play a key role in the global carbon cycle by sequestering CO<sub>2</sub> from the atmosphere. Soils are a very slowly renewable resource, and degradation can occur because of improper land-use practices, climate change, and pollution. Soils are also a key component in the hydrologic cycle; they reduce flooding by slowing runoff and store water during dry periods (Food and Agriculture Organization of the United Nations 2015).

Soil resources, soil conditions, and the importance of Illinois soils for planning and resource utilization have been discussed (Fehrenbacher et al. 1984; Barnhardt 2010). Having knowledge of the chemical composition of soils is important for many reasons, especially soil fertility. Soils contain minerals and naturally occurring elements that provide nutrients essential for plant growth. Among the essential elements are B, Ca, Co, Cr, Cu, Fe, K, Mg, Mn, P, S, Se, V, and Zn. Near urban industrial areas, around mining operations, and along highways, soils often absorb by-products with heavy metals, including As, Ba, Cd, Cr, Cu, Hg, Ni, Pb, and Zn. Researchers need to know the variation in chemical elements contained in soils to predict which areas might require amendments. In areas with contaminated soils, we need to know the variability in concentrations of naturally occurring elements in that area to develop reasonable cleanup objectives. For detailed discussions of soil chemistry and processes and the behavior of metals in soils, see Bohn et al. (1979) or Alloway (1990).

This report serves as a compendium of chemical composition values of Illinois soils. It is based on studies conducted from 1998 to 2005 by the Illinois State Geological Survey (ISGS). An earlier report by Zhang and Frost (2002) provided compositional data on 94 soil samples, but their results were not presented in tabular form usable to researchers. The results of a study by Dreher and Follmer were published in a series of seven open-file progress reports (Dreher et al. 2002, 2003a, 2003b; Dreher and Follmer 2004a, 2004b, 2004c, 2005), referred to

hereafter as the Dreher and Follmer Series. Detailed discussion of the literature concerning soil formation and the chemical characteristics of soils is given in the Dreher and Follmer Series, and the Hg contents of 101 of the 137 soil cores collected in that study are discussed in Dreher and Follmer (2004d). However, their results were not combined into a single final report that included both analytical results and statistical summaries. In 2013, the U.S. Geological Survey (USGS) reported geochemical data on soils of the United States (Smith et al. 2013), and the present compendium includes those results for 88 soil cores collected in Illinois. The 53 elements reported herein are listed in Figure 1. The goal of the present publication is to provide a compilation of the chemical composition of more than 1,200 soil samples collected from across Illinois.<sup>1</sup>

## METHODS AND RESULTS

### Illinois Department of Transportation-Sponsored Background Illinois Soils (Zhang and Frost 2002)

In conjunction with the Illinois Department of Transportation property assessments project, the ISGS collected baseline information on naturally occurring concentrations of elements in soils starting in 1992. The project was designed to collect data that would distinguish between the concentrations of metals representing natural conditions and those resulting from human activities. The locations of the 94 soil samples collected in Illinois are shown in Figure 2. The samples were collected by using soil probes, and composite samples of the A and B soil horizons were made in the field. Subsamples were retained from depths of 4–8 in. (0.1–0.2 m) and 28–32 in. (0.7–0.8 m) below the surface. The composite soil samples were air-dried, disaggregated, riffle-split, and then crushed to pass a 2-mm sieve. A split of the sample was ground using an SPEX 8505 alumina ceramic grinding container (SPEX SamplePrep, Metuchen, NJ) in an SPEX 8500 Shatterbox to pass a 149- $\mu$ m sieve.

<sup>1</sup>Tabular data in electronic format are available for Appendixes 1–6 from the Illinois Geospatial Data Clearinghouse (<https://clearinghouse.isgs.illinois.edu/data/geology/circular-590-inorganic-chemical-composition-of-illinois-soils>).





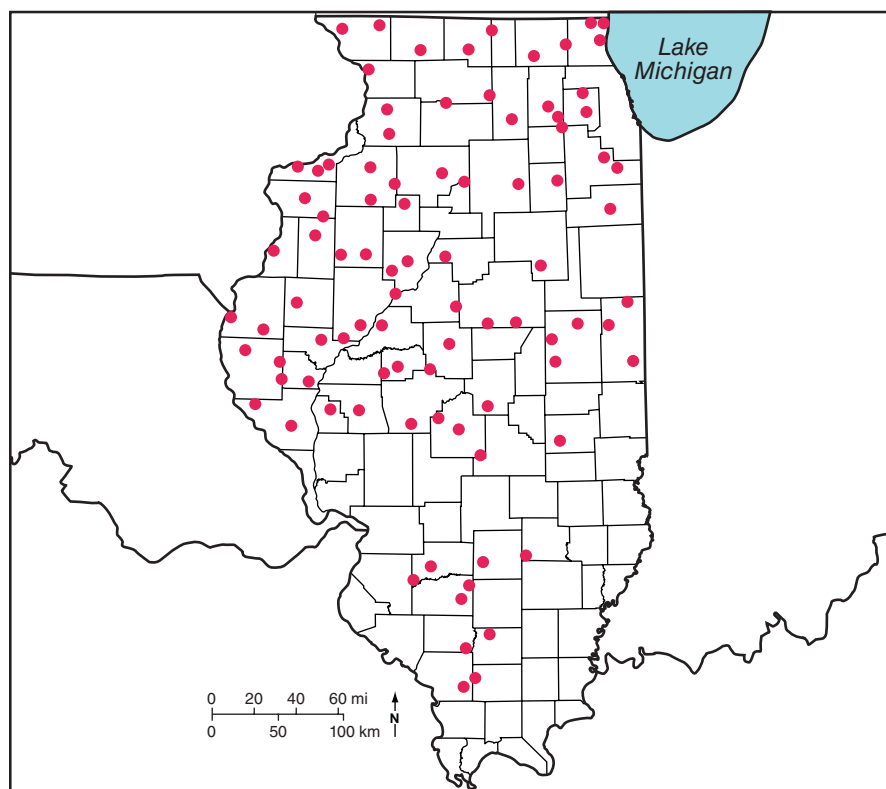

**Figure 2** Site locations of soil samples collected in 1992 (Zhang and Frost 2002).

The following major, minor, and trace element concentrations of the soil samples were determined by using various analytical techniques: Al, Ba, Ca, Fe, K, Mg, Mn, Na, P, Si, Sr, and Ti were determined by X-ray fluorescence (XRF) spectrometry; As, Br, Ce, Co, Cr, Cs, Dy, Eu, Ga, Hf, La, Lu, Rb, Sb, Sc, Se, Sm, Ta, Tb, Th, U, and Yb were determined by instrumental neutron activation analysis (INAA); Cd, Cu, Li, Ni, Pb, and Zn were determined by atomic absorption (AA); Ag, B, Be, Tl, and V were determined by optical emission spectrography (OES); and total, inorganic, and organic carbon were determined by coulometric titration. Loss on ignition was determined gravimetrically. The analytical techniques are described in detail in Zhang and Frost (2002).

The soil chemical analysis results, core identification (ID) numbers, locations, field ID numbers, and depths of the subsamples collected are presented in Appendix 1. Also presented in Appendix 1 are six quality assurance/quality control (QA/QC) replicate samples that were

included in the study to evaluate the precision of the results.

Table 1 provides a summary of the number of samples (n) above the detection limits (DL), means, and ranges of concentrations of the A and B soil horizons adapted from Zhang and Frost (2002). Various samples were omitted from the statistical analysis for the following reasons: samples R18446 to R18449 were collected at the same location as R18450 and R18451; samples R18458 and R18450 were not considered background samples because the core was collected in the town of Lincoln, Illinois; samples R18455 and R18456 were mixtures of A and B horizons; and sample R19376 contained materials from an old mine site.

Regional distribution patterns of soil elemental concentrations as well as concentration variations between the A and B horizons are discussed in Zhang and Frost (2002). A number of trace elements of environmental concern had concentrations that were lower than the DL of the methods. These included all

samples for Ag (1 mg/kg) and Cd (4 mg/kg). Selenium (1 mg/kg) was detected in 15 samples. The greatest concentration of Se in the A horizon samples was 2.6 mg/kg, and the greatest in the B horizon samples was 2.2 mg/kg.

### Statewide Soil Collection (Dreher and Follmer Series)

Soil cores were collected from 1998 to 2003 on a systematic 20-mi (32-km) rectangular grid by using a Gidding hydraulically operated coring device. The cores were briefly described in the field, divided into roughly 2-ft (0.6-m) segments, wrapped in plastic and aluminum foil, and returned to the laboratory for further processing. American Petroleum Institute (API) numbers, core ID numbers, county, soil type, location information in latitude and longitude, elevation, depth of cores, dates of collection, and number of subsamples analyzed are listed in Appendix 2. Location and elevation information were determined by GPS. The locations of the 137 soil cores collected in Illinois are shown in Figure 3.

The soils were unwrapped in the laboratory and described in detail. The core ID number, county, soil texture, soil type, soil association, and land use are listed in Appendix 3. The complete field descriptions of the cores are available from the ISGS Geological Records Unit.

Approximately six subsamples were removed from each core to represent the major horizons encountered in each core. In total, 820 samples were chemically characterized. The samples were disaggregated and then split for further analysis. Soil texture and soil pH were determined on one split. The sample ID number; county; depth interval; horizon; sand, silt, and clay concentrations; and soil texture are listed in Appendix 4.

A second subsample was ground in an SPEX Shatterbox to pass through a 208- $\mu$ m sieve for chemical analysis. The following elemental concentrations were determined: Al, Ba, Ca, Cr, Cu, Fe, K, Mg, Mn, Na, Ni, P, Pb, Rb, Si, Sr, Ti, V, Zn, and Zr were determined by XRF; Hg was determined by cold-vapor AA (CVAA); and total, inorganic, and organic carbon

# Electronic Filing: Received, Clerk's Office 3/24/2022

**Table 1** Mean, range, and number of samples above the detection limits (DL) in A and B horizons of Illinois soils<sup>1</sup>

Element	A horizon (0.1–0.2 m)				B horizon (0.7–0.8 m)			
	n > DL	Mean	Minimum	Maximum	n > DL	Mean	Minimum	Maximum
SiO <sub>2</sub> (%)	90	75.16	56.81	90.34	89	70.85	41.97	91.63
Al <sub>2</sub> O <sub>3</sub> (%)	90	9.56	3.84	17.03	89	11.47	3.83	15.28
Fe <sub>2</sub> O <sub>3</sub> (%)	90	3.38	1.06	7.87	89	4.62	1.01	6.26
MgO (%)	90	0.85	0.20	3.13	89	1.58	0.19	7.75
CaO (%)	90	0.93	0.11	4.59	89	1.74	0.17	15.40
Na <sub>2</sub> O (%)	90	0.98	0.58	1.63	89	0.93	0.42	1.66
K <sub>2</sub> O (%)	90	2.12	1.24	3.98	89	2.20	0.93	4.18
TiO <sub>2</sub> (%)	90	0.70	0.18	0.87	89	0.67	0.17	0.84
P <sub>2</sub> O <sub>5</sub> (%)	90	0.13	0.05	0.28	89	0.10	0.04	0.27
MnO (%)	90	0.12	0.02	0.30	89	0.09	0.02	0.34
LOI (%)	90	5.57	1.18	15.53	89	5.23	0.59	1.86
Total C (%)	90	1.97	0.50	7.52	89	1.04	0.20	5.42
Inorganic C (%)	90	0.15	0.02	1.49	89	0.47	0.01	4.43
Organic C (%)	90	1.82	0.48	6.92	89	0.58	0.02	4.36
As	90	8.7	1.6	17.0	89	11.1	1.9	21.0
B	90	44.7	17.0	70.0	88	46	<10	79
Ba	90	565	245	805	89	535	210	935
Be	75	1.4	<1.0	2.8	78	1.5	<1.0	2.8
Br	90	6.7	2.2	15.0	88	5.1	1.0	15.0
Ce	90	66	16	87	89	70	17	104
Co	90	10.7	2.8	21.0	89	11.5	2.6	20.0
Cr	90	56	19	91	89	63	13	80
Cs	90	3.1	0.7	7.6	89	4.1	0.8	7.8
Cu	90	28	8	69	89	33	12	73
Dy	90	4.5	1.1	7.0	89	4.8	1.3	7.8
Eu	90	1.1	0.3	1.7	89	1.2	0.3	1.9
Ga	90	11.1	5.5	21.0	89	13.5	4.3	19.0
Hf	90	10.2	2.6	14.0	89	8.8	3.0	13.0
La	90	32.5	8.9	46	89	34	9.5	48
Li	90	18.5	3.0	74	89	23.3	3.0	53.4
Lu	90	0.45	0.15	0.56	89	0.47	0.16	0.65
Ni	22	22	<20	53	45	24	<10	63
Pb	87	27	<10	250	84	23	<10	106
Rb	90	80	34	140	89	81	36	150
Sb	90	0.9	0.2	2.0	89	1.0	0.2	2.0
Sc	90	8.0	1.9	19.0	89	10.2	1.9	15.0
Sm	90	5.1	1.3	8.2	89	5.8	1.4	8.8
Sr	90	103	55	165	89	109	60	390
Ta	90	0.91	0.19	1.10	89	0.88	0.21	1.10
Tb	90	0.74	0.20	1.10	89	0.80	0.20	1.30
Th	90	8.9	2.0	12.0	89	9.6	2.2	12.0
Tl	74	1.4	<1	3.0	70	1.3	<1	3.0
U	89	3.4	<1.5	6.1	88	3.4	<1.5	6.7
V	90	84.6	22	260	89	106	20	183
Yb	90	2.7	0.8	3.5	89	2.8	0.7	4.0
Zn	90	72.6	19	258	89	71.5	17.0	144

<sup>1</sup>Adapted from Zhang and Frost (2002). All values are in milligrams per kilogram (mg/kg) unless otherwise noted. Detection limits not provided in Zhang and Frost (2002). n, number of samples; LOI, loss on ignition.

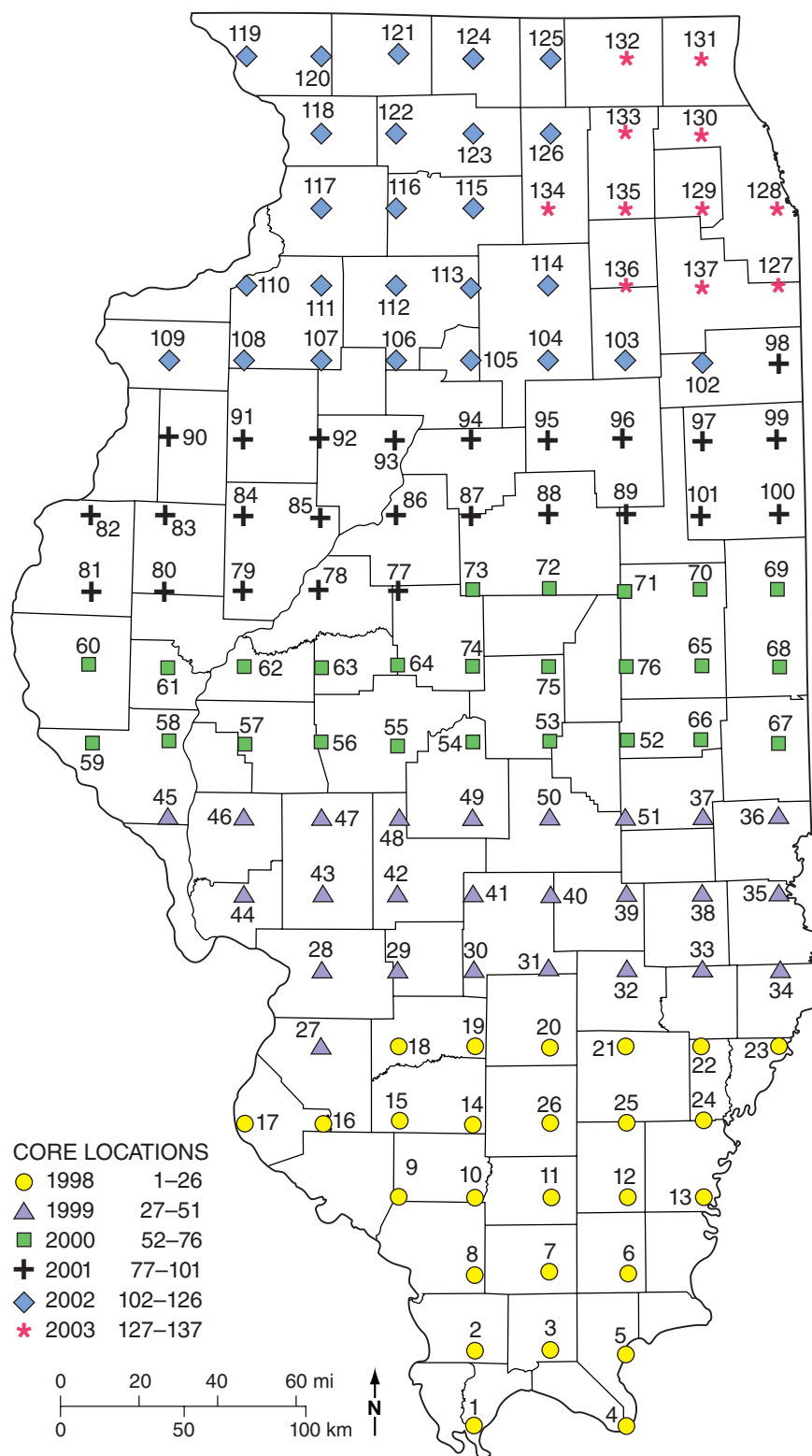

**Figure 3** Core locations and years the soil cores were collected for the Dreher and Follmer Series (Dreher et al. 2002, 2003a, 2003b; Dreher and Follmer 2004a, 2004b, 2004c, 2005). The numbers represent sample identification numbers. Results from this series of studies are presented in Appendixes 2–5.

were determined by coulometric titration. The laboratory number, sample ID number, county, horizon, depth interval, pH, and elemental concentrations are listed in Appendix 5. Details for all procedures can be found in the Dreher and Follmer Series reports.

Quality assurance/quality control results were not reported in the Dreher and Follmer Series reports. However, during the first 2 years of the project, QA/QC results were determined by XRF from unpublished results (Zhang 2002). Accuracy values relative to National Institute of Standards & Technology Standard Reference Material (NIST SRM) 2709, San Joaquin Soil concentrations, are given in Table 2 along with the DL for each.

Results of QA/QC for Hg soil analysis are shown in Table 3 (Dreher and Follmer 2004d). Accuracy values relative to Canadian Certified Reference Program soils (SO-2, SO-3, SO-4) and NIST SRM 2709 are given. The DL of the method is approximately 2 µg/kg.

Tables 4 and 5 provide a summary of the number of samples above the DL, means, and ranges of concentrations for all the samples, as well as for the A-, B-, and C-horizon soils adapted from the Dreher and Follmer Series. Because of the occurrence of coal, asphalt, or both in core 122 (collected at the end of an abandoned roadbed), data from the upper three samples (0.0–0.6 m) of this core were excluded from the calculation of means and ranges of element contents.

## DISCUSSION

Direct comparisons of the results of the two studies have some limitations because of the different analytical techniques used. The study by Zhang and Frost (2002) included AA, INAA, and OES techniques, which have lower DL and better precision for low concentrations of trace elements compared with XRF, which was used in the Dreher and Follmer Series reports. Tables 6 and 7 list the mean, median, range, and lower and upper quartile concentrations of elements in the uppermost intervals analyzed in the two studies.

**Table 2** Quality assurance/quality control results relative to NIST SRM 2709 by X-ray fluorescence spectrometry analyzed during the first 2 years of the project<sup>1</sup>

Element	Certified value	Determined value	n	DL
SiO <sub>2</sub> (%)	63.45 ± 0.49	62.9 ± 0.3	23	0.01
Al <sub>2</sub> O <sub>3</sub> (%)	14.17 ± 0.11	15.5 ± 0.3	23	0.10
Fe <sub>2</sub> O <sub>3</sub> (%)	5.00 ± 0.16	5.73 ± 0.21	23	0.01
MgO (%)	2.50 ± 0.08	2.40 ± 0.04	23	0.05
CaO (%)	2.64 ± 0.07	2.64 ± 0.03	23	0.01
Na <sub>2</sub> O (%)	1.56 ± 0.04	1.36 ± 0.07	23	0.1
K <sub>2</sub> O (%)	2.44 ± 0.07	2.41 ± 0.03	23	0.05
TiO <sub>2</sub> (%)	0.57 ± 0.04	0.55 ± 0.02	23	0.01
P <sub>2</sub> O <sub>5</sub> (%)	0.14 ± 0.01	0.15 ± 0.01	23	0.01
MnO (%)	0.07 ± 0.01	0.08 ± 0.003	23	0.01
Ba	968 ± 40	998 ± 67	23	100
Cr	130 ± 4	114 ± 11	15	5
Cu	34.6 ± 0.7	37 ± 1.2	15	5
Ni	88 ± 5	56 ± 3.8	15	5
Pb	18.9 ± 0.5	20 ± 0.8	15	5
Rb	96*	100 ± 3	15	5
Sr	231 ± 2	250 ± 11	23	50
V	112 ± 5	101 ± 4	15	35
Zn	106 ± 3	108 ± 4	15	5
Zr	160*	139 ± 4	23	50

<sup>1</sup>Dreher and Follmer Series (Dreher et al. 2002, 2003a, 2003b; Dreher and Follmer 2004a, 2004b, 2004c, 2005) and Zhang and Frost (2002). An asterisk (\*) indicates noncertified values. All values are in milligrams per kilograms (mg/kg) unless otherwise noted. NIST SRM, National Institute of Standards & Technology Standard Reference Material; n, number of samples; DL, detection limits.

**Table 3** Quality assurance/quality control results for Hg analysis in four reference materials<sup>1</sup>

Material	Certified value (µg/kg)	Determined value (µg/kg)	n
SO-2	82 ± 9	92.8 ± 5.4	19
SO-3	17 ± 7	15.8 ± 2.8	14
SO-4	30 ± 6	28.2 ± 6.8	14
NIST SRM 2709	1,400 ± 80	1,418 ± 41	44

<sup>1</sup>Dreher and Follmer (2004d). n, number of samples; SO-2, SO-3, SO-4, Canadian Certified Reference Program soils; NIST SRM, National Institute of Standards & Technology Standard Reference Material.

# Electronic Filing: Received, Clerk's Office 3/24/2022

**Table 4** Mean, range, detection limits (DL), and number of samples above the DL in all samples and in the A horizon of Illinois soils<sup>1</sup>

Element	DL	All samples				A horizon (0.1–0.2 m)			
		n > DL	Mean	Minimum	Maximum	n > DL	Mean	Minimum	Maximum
Sand (%)		816	15.29	0.05	96.04	239	13.10	0.31	91.14
Silt (%)		816	59.24	1.02	89.66	239	63.66	2.24	86.38
Clay (%)		816	25.44	0.40	80.77	239	23.08	2.60	42.24
SiO <sub>2</sub> (%)	0.01	817	72.50	28.44	98.80	239	75.41	58.92	98.80
Al <sub>2</sub> O <sub>3</sub> (%)	0.10	817	10.80	2.50	21.10	239	9.86	3.40	16.30
Fe <sub>2</sub> O <sub>3</sub> (%)	0.01	817	3.98	0.71	16.40	239	3.37	1.07	6.44
MgO (%)	0.05	816	1.43	<0.05	13.71	239	0.81	0.07	3.81
CaO (%)	0.01	817	1.75	0.12	19.12	239	1.04	0.12	8.73
Na <sub>2</sub> O (%)	0.10	817	0.86	0.16	1.74	239	0.89	0.45	1.45
K <sub>2</sub> O (%)	0.05	817	2.09	0.72	4.82	239	1.99	1.08	3.07
TiO <sub>2</sub> (%)	0.01	817	0.66	0.07	1.08	239	0.69	0.09	1.08
P <sub>2</sub> O <sub>5</sub> (%)	0.01	817	0.11	0.02	0.36	239	0.14	0.04	0.36
MnO (%)	0.01	816	0.10	0.01	0.78	238	0.12	<0.02	0.50
Total C (%)	0.01	817	1.28	0.05	14.16	239	1.75	0.17	7.46
Inorganic C (%)	0.01	816	0.47	<0.01	7.88	239	0.14	0.01	1.99
Organic C (%)	0.01	816	0.81	<0.01	13.98	239	1.61	0.12	6.53
pH		816	6.55	3.57	8.71	239	6.36	4.19	8.17
Ba	100	809	546	<100	1,467	237	571	<100	1,448
Cr	5	781	85	<5	756	223	77	<5	756
Cu	5	806	26	<5	133	234	25	<5	53
Hg (µg/kg)	2	810	30	<2	124	239	36	0.08	124
Ni	5	768	25	<5	129	218	20	<5	51
Pb	5	807	21	<5	147	235	24	<5	147
Rb	5	809	77	20	191	235	75	24	152
Sr	50	816	125	<50	255	239	123	67	201
V	35	809	84	<35	172	228	79	<35	127
Zn	5	809	68	<5	209	235	68	<5	209
Zr	50	816	313	53	586	239	350	69	586

<sup>1</sup>Adapted from the Dreher and Follmer Series (Dreher et al. 2002, 2003a, 2003b; Dreher and Follmer 2004a, 2004b, 2004c, 2005). All values are in milligrams per kilogram (mg/kg) unless otherwise noted. n, number of samples.

**Table 5** Mean, range, and number of samples above the detection limits (DL) in the B and C horizons of Illinois soils<sup>1</sup>

Element	B horizon (0.7–0.8 m)				C horizon (~1.3 m depth)			
	n > DL	Mean	Minimum	Maximum	n > DL	Mean	Minimum	Maximum
Sand (%)	306	11.77	0.20	95.42	104	23.42	0.22	96.04
Silt (%)	306	58.02	2.94	81.96	104	58.12	1.02	89.66
Clay (%)	306	30.12	0.40	74.07	104	18.46	1.10	51.28
SiO <sub>2</sub> (%)	306	72.39	52.09	92.20	104	70.09	28.44	93.60
Al <sub>2</sub> O <sub>3</sub> (%)	306	12.27	3.06	21.10	104	9.33	2.50	15.82
Fe <sub>2</sub> O <sub>3</sub> (%)	306	4.73	1.16	16.40	104	3.32	0.71	7.78
MgO (%)	306	1.18	0.06	6.72	104	2.55	0.08	13.71
CaO (%)	306	1.04	0.13	12.11	104	3.73	0.12	19.12
Na <sub>2</sub> O (%)	306	0.87	0.21	1.50	104	0.92	0.16	1.74
K <sub>2</sub> O (%)	306	2.09	1.02	4.53	104	2.08	0.72	4.75
TiO <sub>2</sub> (%)	306	0.68	0.10	1.05	104	0.56	0.07	0.93
P <sub>2</sub> O <sub>5</sub> (%)	306	0.10	0.03	0.33	104	0.10	0.03	0.23
MnO (%)	306	0.10	0.02	0.78	104	0.08	0.02	0.19
Total C (%)	306	0.69	0.05	7.79	104	1.63	0.06	8.24
Inorganic C (%)	305	0.17	<0.01	4.24	104	1.28	0.01	7.88
Organic C (%)	306	0.52	0.04	5.22	103	0.35	0.02	3.06
pH	306	6.31	3.74	8.22	104	7.31	3.98	8.71
Ba	306	583	108	1,467	103	470	<100	1,211
Cr	302	99	<5	441	96	79	<5	373
Cu	304	29	<5	80	101	24	<5	133
Hg (µg/kg)	302	37	<2	101	102	24	<2	71
Ni	301	30	<5	129	100	23	<5	71
Pb	304	20	<5	107	102	16	<5	28
Rb	304	81	34	177	103	69	20	179
Sr	306	126	74	219	104	133	64	255
V	298	97	<35	172	89	77	<35	128
Zn	304	73	<5	198	103	56	<5	112
Zr	306	316	63	543	104	279	53	569

<sup>1</sup>Adapted from the Dreher and Follmer Series (Dreher et al. 2002, 2003a, 2003b; Dreher and Follmer 2004a, 2004b, 2004c, 2005). All values are in milligrams per kilogram (mg/kg) unless otherwise noted. n, number of samples.

**Table 6** Comparison of mean, median, range, and lower and upper quartile concentrations of major elements in the uppermost intervals of soil cores<sup>1</sup>

Element (%)	Mean	Median	Minimum	Maximum	Lower quartile	Upper quartile
Zhang and Frost, A horizon (0.1–0.2 m), n = 90						
SiO <sub>2</sub>	75.16	75.65	56.8	90.34	72.61	78.55
Al <sub>2</sub> O <sub>3</sub>	9.56	9.51	3.84	17.03	8.72	10.31
Fe <sub>2</sub> O <sub>3</sub>	3.38	3.29	1.06	7.87	2.73	3.68
MgO	0.84	0.71	0.01	3.13	0.55	0.94
CaO	0.93	0.73	0.11	4.59	0.51	1.00
Na <sub>2</sub> O	0.98	0.98	0.58	1.63	0.86	1.11
K <sub>2</sub> O	2.12	2.12	0.18	3.98	1.93	2.25
TiO <sub>2</sub>	0.70	0.73	1.18	0.87	0.67	0.77
P <sub>2</sub> O <sub>5</sub>	0.13	0.12	0.05	0.28	0.09	0.15
MnO	0.12	0.12	0.02	0.30	0.09	0.14
Total C	1.96	1.59	0.50	7.52	1.07	2.83
Inorganic C	0.15	0.05	0.02	1.49	0.03	0.16
Organic C	1.82	1.52	0.48	6.92	1.01	2.41
Dreher and Follmer Series, top interval (0–0.3 m), n = 136						
SiO <sub>2</sub>	75.12	75.33	53.40	98.80	71.80	78.73
Al <sub>2</sub> O <sub>3</sub>	9.51	9.58	3.60	14.80	8.00	10.86
Fe <sub>2</sub> O <sub>3</sub>	3.23	3.19	1.22	5.93	2.56	3.86
MgO	0.83	0.76	0.07	3.81	0.46	1.10
CaO	1.29	0.92	0.18	12.11	0.67	1.33
Na <sub>2</sub> O	0.89	0.90	0.45	1.23	0.78	1.00
K <sub>2</sub> O	2.01	2.01	1.11	2.95	1.86	2.13
TiO <sub>2</sub>	0.69	0.71	0.18	1.04	0.63	0.77
P <sub>2</sub> O <sub>5</sub>	0.15	0.14	0.05	0.36	0.11	0.17
MnO	0.13	0.11	0.02	0.50	0.08	0.15
Total C	2.08	1.85	0.44	7.79	1.31	2.61
Inorganic C	0.21	0.09	0.02	2.57	0.05	0.18
Organic C	1.88	1.68	0.41	6.27	1.17	2.29

<sup>1</sup>Zhang and Frost (2002) and Dreher and Follmer Series (Dreher et al. 2002, 2003a, 2003b; Dreher and Follmer 2004a, 2004b, 2004c, 2005). n, number of samples.

**Table 7** Comparison of mean, median, range, and lower and upper quartile concentrations of trace elements in the uppermost intervals of soil cores<sup>1</sup>

Element	Mean	Median	Minimum	Maximum	Lower quartile	Upper quartile
Zhang and Frost, A horizon (0.1–0.2 m), n = 90						
As	8.7	8.3	1.6	17	7.0	10.0
Ba	565	582	245	805	490	640
Be	1.4	1.3	<1	2.8	1.1	1.6
Cr	56	58	19	91	53	61
Cu	28	25	8	69	19	33
Ni	22	18	<20	53	16	28
Pb	27	20	<10	250	16	31
Rb	80	77	34	140	70	87
Sb	0.9	0.9	0.2	2.0	0.8	1.1
Sr	103	100	55	165	90	115
Tl	1.4	1.0	<1	3.0	1.0	2.0
V	85	82	22	260	66	95
Zn	73	64	19	258	47	87
Dreher and Follmer Series, top interval (0.0–0.3 m), n = 136						
Ba	570	576	140	1,216	442	684
Cr	71	60	<5	633	33	94
Cu	24	23	<5	53	20	28
Hg ( $\mu$ /kg)	35	30	8	123	25	40
Ni	20	21	<5	49	9	28
Pb	27	22	<5	147	19	28
Rb	74	72	24	138	59	89
Sr	123	123	67	179	111	136
V	77	74	<35	117	67	88
Zn	71	67	7	209	50	88

<sup>1</sup>Zhang and Frost (2002) and Dreher and Follmer Series (Dreher et al. 2002, 2003a, 2003b; Dreher and Follmer 2004a, 2004b, 2004c, 2005). All values are in milligrams per kilogram (mg/kg) unless otherwise noted. n, number of samples; ND, not determined.



The USGS deemed there was a critical need to create a data set that would provide knowledge about the concentrations and spatial distribution of naturally occurring elements in soils of the United States (Smith et al. 2013). Soil samples were collected on a random grid of approximately one sample per 1,600 km (994 mi). In total, 4,857 target sites were established. Soils were collected in the most representative geomorphic setting within 1 km<sup>2</sup> (0.39 mi<sup>2</sup>) of the target area and obvious contaminated areas were avoided, including proximity to highways, buildings, and active major industrial areas. The landscape and land use were recorded for each site. A soil sample was collected at the surface (0–5 cm), a composite sample was made of the A horizon (~0–20 cm), and a deeper composite sample was made of the C horizon (depth of ~1.3 m). The majority of the 45 major and trace elements were determined by inductively coupled plasma-mass spectrometry by using a near total digestion (see Table 8). Arsenic and Se were determined by hydride generation absorption spectrometry and Hg was determined by CVAA. Total carbon was determined with an automated carbon analyzer. Inorganic carbon concentration was calculated from mineralogical data for the carbonate minerals calcite, dolomite, and aragonite. Quality assurance/quality control tables of concentrations determined on an internal project standard as well as the coefficients of variation from analytical duplicates are available in Smith et al. (2013; see Tables 6 and 7).

The soil geochemical data from the nationwide USGS study are available in downloadable tables (Smith et al. 2013). The 88 locations sampled in Illinois are shown in Figure 4. The geochemical data for Illinois are presented in Appendix 6. The results have been combined so that the three intervals sampled for each core are listed together and the results are sorted by county. The lower limits of detection; number of samples above the detection limits; and mean, minimum, and maximum concentrations for each of the three sampling intervals for Illinois soils are presented in Table 8. The

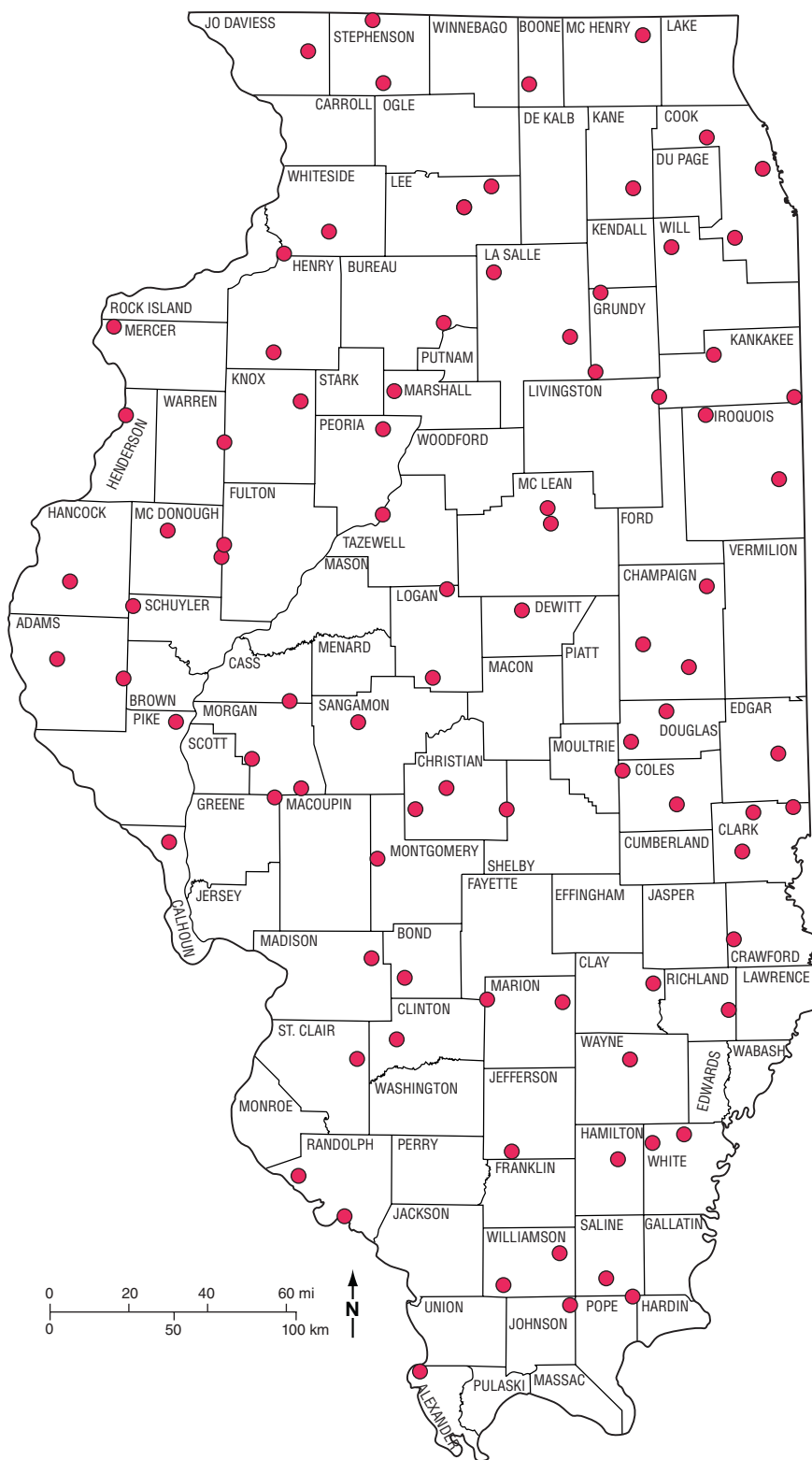

**Figure 4** Core locations of Illinois soils sampled by the U.S. Geological Survey (Smith et al. 2013).

# Electronic Filing: Received, Clerk's Office 3/24/2022

**Table 8** Lower limits of detection (LLD), mean, range, and number of samples above the detection limits (DL) in the surface, A horizon, and C horizon of Illinois soils<sup>1</sup>

Element	LLD	Surface (0–5 cm)				A horizon (~0–20 cm)				C horizon (~1.3 m depth)			
		n > DL	Mean	Min	Max	n > DL	Mean	Min	Max	n > DL	Mean	Min	Max
Al <sub>2</sub> O <sub>3</sub> (%)	0.02	88	8.04	4.04	11.62	88	8.18	4.00	12.01	88	9.50	3.66	17.08
Fe <sub>2</sub> O <sub>3</sub> (%)	0.01	88	2.82	1.33	6.44	88	2.88	1.10	12.10	88	3.63	0.44	8.55
MgO (%)	0.02	88	0.87	0.30	3.98	88	0.81	0.30	3.60	88	2.05	0.15	9.37
CaO (%)	0.01	88	1.40	0.34	10.35	88	1.31	0.22	9.28	88	2.63	0.35	15.11
NaO (%)	0.01	88	0.89	0.38	1.39	88	0.89	0.35	1.40	88	0.90	0.24	1.59
K <sub>2</sub> O (%)	0.01	88	1.93	1.24	3.02	88	1.92	0.84	2.60	88	2.04	1.07	3.60
TiO <sub>2</sub> (%)	0.02	88	0.46	0.15	0.65	88	0.46	0.15	0.63	88	0.47	0.05	0.73
SO <sub>3</sub> (%)	0.02	88	1.14	0.37	1.62	88	0.13	0.05	1.67	86	0.07	0.02	0.22
P <sub>2</sub> O <sub>5</sub> (%)	0.01	88	0.22	0.06	0.73	88	0.20	0.04	0.76	88	0.10	0.01	0.26
MnO (%)	0.006	88	0.10	0.02	0.24	88	0.10	0.00	0.30	88	0.08	0.00	0.33
Total C (%)	0.01	*	*	*	*	88	2.83	0.89	23.00	88	1.11	0.06	5.77
Inorganic C (%)	0.2	*	*	*	*	21	0.61	0.10	2.20	37	1.91	0.10	5.80
Organic C (%)	0.01	*	*	*	*	88	2.68	0.89	23.00	79	0.36	0.00	3.80
Ag	1	0	<1			0	<1			0	<1		
As	0.6	88	7.5	2.3	21.6	88	7.5	2.0	17.6	88	7.8	1.3	17.0
Ba	5	88	527	314	731	88	543	329	784	88	502	288	806
Be	0.1	88	1.2	0.6	2.9	88	1.3	0.6	4.4	87	1.4	0.4	2.9
Bi	0.04	87	0.18	0.05	0.33	88	0.18	0.06	0.31	86	0.18	0.07	0.38
Cd	0.1	85	0.3	0.1	2.3	84	0.3	0.1	2.8	68	0.2	0.1	0.6
Ce	0.05	88	54.1	17.0	77.0	88	55.3	18.7	76.4	88	55.7	11.9	87.5
Co	0.1	88	9.7	2.8	16.7	88	10.1	3.4	17.5	88	10.8	1.6	24.7
Cr	1	88	40	10	67	88	39	10	75	88	36	3	68
Cs	5	6	5	5	6	8	6	5	7	22	6	5	8
Cu	0.5	88	19.1	5.1	54.5	88	20.1	6.9	166.0	88	19.5	2.9	37.9
Ga	0.05	88	9.6	4.4	15.8	88	10.0	4.2	18.1	88	11.6	4.0	21.5
Hg (µg/kg)	0.01	88	0.04	0.02	0.25	88	0.04	0.02	0.13	85	0.03	0.01	0.17
In	0.02	82	0.03	0.02	0.08	82	0.03	0.02	0.10	85	0.04	0.02	0.08
La	0.5	88	27.7	8.8	38.8	88	28.0	9.8	36.6	88	28.5	6.4	40.8
Li	1	88	21.7	6	81	88	21	5	41	88	29	4	63
Mo	0.05	88	1.2	0.3	12.3	88	1.3	0.3	22.3	88	1.7	0.1	12.5
Nb	0.1	88	8.8	2.3	12.1	88	9.2	2.5	11.5	88	8.7	1.0	12.7
Ni	0.5	88	16.9	5.8	42.6	88	16.6	6.6	40.5	88	25.1	4.2	60.7
Pb	0.5	88	26.4	14.0	103.0	88	26.2	15.1	75.9	88	17.0	6.3	30.2
Rb	0.2	88	67.3	33.1	109.0	88	71.3	29.5	113.0	88	71.4	34.0	123.0
Sb	0.05	88	0.7	0.2	2.2	88	0.8	0.3	9.1	88	0.6	0.1	1.4
Sc	0.1	88	6.0	2.1	11.1	88	6.3	2.2	11.8	88	8.0	1.1	16.4
Se	0.2	81	0.5	0.2	1.7	85	0.5	0.2	2.8	21	0.3	0.2	0.6
Sn	0.1	88	1.6	0.7	6.0	88	1.6	0.8	4.5	88	1.4	0.2	7.1
Sr	0.5	88	104.0	72.2	364.0	88	105.0	73.8	343.0	88	108.8	58.2	184.0
Te	0.1	0	<0.1			0	<0.1			2	0.1	<0.1	0.1
Th	0.2	88	8.7	2.3	11.5	88	8.7	2.5	11.1	88	8.5	1.4	12.7
Tl	0.1	88	0.5	0.2	1.1	88	0.5	0.3	1.4	88	0.6	0.2	1.5
U	0.1	88	2.7	0.7	4.5	88	2.8	0.8	6.3	88	2.5	0.4	5.1
V	1	88	55	19	96	88	57	21	89	88	68	9	148
W	0.1	88	0.9	0.2	1.5	88	1.0	0.3	1.5	87	0.9	0.1	2.1
Y	0.1	88	15.7	6.1	28.4	88	16.4	7.4	24.9	88	19.6	3.0	45.1
Zn	1	88	82	27	301	88	80	29	288	88	61	9	161

<sup>1</sup>Adapted from Smith et al. (2013). An asterisk (\*) indicates not measured in the 0- to 5-cm sampling interval. All values are in milligrams per kilogram (mg/kg) unless otherwise noted. n, number of samples.

# Electronic Filing: Received, Clerk's Office 3/24/2022

**Table 9** Combined results of the mean, range, and number of samples above the detection limits (DL) in the A horizon of Illinois soils<sup>1</sup>

Element	USGS				Zhang and Frost				Dreher and Follmer Series			
	n > DL	Mean	Min	Max	n > DL	Mean	Min	Max	n > DL	Mean	Min	Max
Al <sub>2</sub> O <sub>3</sub> (%)	88	8.18	4.00	12.01	90	9.56	3.84	17.03	239	9.86	3.40	16.30
Fe <sub>2</sub> O <sub>3</sub> (%)	88	2.88	1.10	12.10	90	3.38	1.06	7.87	239	3.37	1.07	6.44
MgO (%)	88	0.81	0.30	3.60	90	0.85	0.20	3.13	239	0.81	0.07	3.81
CaO (%)	88	1.31	0.22	9.28	90	0.93	0.11	4.59	239	1.04	0.12	8.73
NaO (%)	88	0.89	0.35	1.40	90	0.99	0.58	1.63	239	0.89	0.45	1.45
K <sub>2</sub> O (%)	88	1.92	0.84	2.60	90	2.12	1.24	3.98	239	1.99	1.08	3.07
TiO <sub>2</sub> (%)	88	0.46	0.15	0.63	90	0.70	0.18	0.87	239	0.69	0.09	1.08
SO <sub>3</sub> (%)	88	0.13	0.05	1.67	90							
P <sub>2</sub> O <sub>5</sub> (%)	88	0.20	0.04	0.76	90	0.13	0.05	0.28	239	0.14	0.04	0.36
MnO (%)	88	0.10	0.00	0.30	90	0.12	0.02	0.30	239	0.12	<0.02	0.50
Total C (%)	88	2.83	0.89	23.00	90	1.97	0.50	7.52	239	1.73	0.17	7.07
Inorganic C (%)	21	0.61	0.10	2.20	90	0.15	0.02	1.49	239	0.15	0.01	2.07
Organic C (%)	88	2.68	0.89	23.00	90	1.82	0.48	6.92	239	1.59	0.12	6.27
Ag	0	<1			0	<1						
As	88	7.5	2.0	17.6	90	8.7	1.6	17.0				
B					90	44.7	17.0	70.0				
Ba	88	543	329	784	90	565	24	805	237	571	<100	1,448
Be	88	1.3	0.6	4.4	75	1.4	<1	2.8				
Bi	88	0.18	0.06	0.31								
Cd	84	0.3	0.1	2.8	0	<4						
Ce	88	55.3	18.7	76.4	90	66.0	16.0	87.0				
Co	88	10.1	3.4	17.5	90	10.7	2.8	21.0				
Cr	88	39	10	75	90	56	19	91	223	77	<5	756
Cs	8	6	5	7	90	3.1	0.7	8				
Cu	88	20.1	6.9	166.0	90	28.0	8.0	69.0	234	25.0	<5	53.0
Ga	88	10.0	4.2	18.1	90	11.1	5.5	21.0				
Hg (µg/kg)	88	0.04	0.02	0.13					239	0.03	0.01	0.12
In	82	0.03	0.02	0.10								
La	88	28.0	9.8	36.6	90	32.5	8.9	46.0				
Li	88	21	5	41	90	19	3	74				
Mo	88	1.3	0.3	22.3								
Nb	88	9.2	2.5	11.5								
Ni	88	16.6	6.6	40.5	22	22.0	<20	53.0	218	20.0	<5	51.0
Pb	88	26.2	15.1	75.9	87	27.0	<10	250.0	235	24.0	<5	147.0
Rb	88	71.3	29.5	113.0	90	80.0	34.0	140.0	235	75.0	24.0	152.0
Sb	88	0.8	0.3	9.1	90	0.9	0.2	2.0				
Sc	88	6.3	2.2	11.8	90	8.0	1.9	19.0				
Se	85	0.5	0.2	2.8	8	1.2	<1	2.6				
Sn	88	1.6	0.8	4.5								
Sr	88	105.0	73.8	343.0	90	103.0	55.0	165.0	239	123.0	67.0	201.0
Th	88	8.7	2.5	11.1	90	8.9	2.0	12.0				
Tl	88	0.5	0.3	1.4	74	1.4	<1					
U	88	2.8	0.8	6.3	89	3.4	<1.5	6.1				
V	88	57	21	89	90	85	22	260	228	79	<35	127
W	88	1.0	0.3	1.5								
Y	88	16.4	7.4	24.9								
Zn	88	80	29	288	90	73	19	258	239	68	<5	209

<sup>1</sup>U.S. Geological Survey (Smith et al. 2013), Zhang and Frost (2002), and Dreher and Follmer Series (Dreher et al. 2002, 2003a, 2003b; Dreher and Follmer 2004a, 2004b, 2004c, 2005). All values are in milligrams per kilogram (mg/kg) unless otherwise noted. n, number of samples.

combined results for A-horizon Illinois soils from the three studies (Zhang and Frost 2002; Dreher and Follmer Series; Smith et al. 2013) are summarized in Table 9.

In general, few differences in concentration were found between the 0- to 5-cm interval and the A horizon, with the exception of  $\text{SO}_3$ , which was much higher in the 0- to 5-cm interval. For the A-horizon soils, the concentrations were similar across the three studies. However, the mean concentrations of CaO;  $\text{P}_2\text{O}_5$ ; and total, inorganic, and organic carbon were higher in the USGS study than in the other two studies, whereas the mean concentrations of Cr, Cu, Ni,  $\text{TiO}_2$ , and V were lower. This difference could have been due in part to the analytical techniques used.

Box and whisker plots of the concentrations of  $\text{Al}_2\text{O}_3$ , As, Ba, CaO, Cr, Cu,  $\text{Fe}_2\text{O}_3$ , Hg,  $\text{K}_2\text{O}$ , MgO, MnO,  $\text{Na}_2\text{O}$ , Ni, organic C,  $\text{P}_2\text{O}_5$ , Pb, Rb, Sr,  $\text{TiO}_2$ , and Zn for all soil intervals are shown in Appendix 7 (Zhang and Frost 2002; Dreher and Follmer Series; Smith et al. 2013). The symbol z in the plots refers to Zhang and Frost (2002), the symbol d refers to the Dreher and Follmer Series, and the symbol u refers to Smith et al. (2013). In general, the median and 25% and 75% quartile concentrations are similar for the three studies. Maximum concentrations of As, Cu,  $\text{Fe}_2\text{O}_3$ , Hg, MnO, Ni, organic C,  $\text{P}_2\text{O}_5$ , and Pb generally varied from 2 to 3 times between the three data sets. The Cr distribution determined in the Dreher and Follmer Series showed 35 samples with concentrations greater than 200 mg/kg and 200 samples with concentrations greater than 100 mg/kg. In contrast, concentrations of Cr did not exceed 100 mg/kg in Zhang and Frost (2002) and Smith et al. (2013). The frequent erratic distribution of Cr in soil cores was noted in the Dreher and Follmer Series, in which unusually high Cr contents were observed.

Selected soil concentrations determined by Jones (1986, 1989, 2002) and the Illinois Environmental Protection Agency (IEPA 1994) are presented in Tables 10 and 11. Surface horizon soils from all major physiographic regions of Illinois were included in the studies by Jones

**Table 10** Mean, median, and range of Ba, Cd, Rb, and Zn concentrations in Illinois soils<sup>1</sup>

Element	n	Mean	Median	Minimum	Maximum
Ba	174	613	610	366	1,070
Cd	72	0.28		0.1	0.9
Rb	223	89		40	140
Zn	150	60		10	130

<sup>1</sup>Jones (1986, 1989, 2002). All values are in milligrams per kilogram (mg/kg). n, number of samples.

**Table 11** Mean, median, and range of elemental concentrations in Illinois soils<sup>1</sup>

Element	n	Mean	Median	Minimum	Maximum
Ag	233	0.84	0.50	<0.06	5.9
As	234	6.7	5.9	0.35	24
Ba	251	130	119	<5	1,720
Be	213	0.7	0.6	<0.02	9.9
Cd	243	1.0	0.5	<0.2	8.2
Cr	261	17	14	<2	151
Cu	254	20	14	1	156
Hg ( $\mu\text{g}/\text{kg}$ )	200	110	60	<10	1,670
Ni	252	17	14	<3	135
Pb	267	49	25	5	647
Sb	142	3.7	3.6	0.2	8.6
Tl	191	0.6	0.4	0.02	2.8
V	214	25	25	<2.5	80
Zn	246	103	67	<5	798

<sup>1</sup>Illinois Environmental Protection Agency (1994). All values are in milligrams per kilogram (mg/kg) unless otherwise noted. n, number of samples.

(1986, 1989, 2002). The IEPA (1994) study included samples from every county in Illinois, collected at background locations that were judged as undisturbed and unaffected by site-related activities.

Results from the two ISGS studies are comparable to those from studies by Jones (1986, 1989, 2002). In contrast, the IEPA (1994) results show lower values for Ba, Cr, and V and higher values for Sb, Pb, and Hg. These results could have been due to the analytical techniques used as well as the large number of samples collected in metropolitan areas compared with the ISGS studies. Urban soils may have been affected by anthropogenic activities.

## SUMMARY

This report presents results of a comprehensive suite of elements in Illinois soils from three studies. Surface samples as well as samples from the major soil horizons are included in tabular form. Summary tables and graphs are provided that compare results of the three studies. In general, the median and 25% and 75% quartile concentrations are similar in the three studies. The data can be used in investigations involving soil constituents and their concentrations. In this report, no attempt was made to discuss geochemical associations of the elements or to plot the results to establish regional trends.

**REFERENCES**

- Alloway, B.J., ed., 1990, Heavy metals in soils: Glasgow, Blackie Academic & Professional, 368 p.
- Barnhardt, M.L., 2010, Soils, *in* D.R. Kolata and C.K. Nimz, eds., *Geology of Illinois*: Champaign, Illinois State Geological Survey, p. 373–384.
- Bohn, H., B. McNeal, and G. O'Connor, 1979, *Soil chemistry*: New York, John Wiley & Sons, 320 p.
- Dreher, G.B., and L.R. Follmer, 2004a, A progress report on the description of the geology and chemical composition of soils in Illinois: Cores 52 through 76: Champaign, Illinois State Geological Survey, Open-File Series 2004-10, 130 p.
- Dreher, G.B., and L.R. Follmer, 2004b, A progress report on the description of the geology and chemical composition of soils in Illinois: Cores 77 through 101: Champaign, Illinois State Geological Survey, Open-File Series 2004-11, 133 p.
- Dreher, G.B., and L.R. Follmer, 2004c, A progress report on the description of the geology and chemical composition of soils in Illinois: Cores 102 through 126: Champaign, Illinois State Geological Survey, Open-File Series 2004-15, 130 p.
- Dreher, G.B., and L.R. Follmer, 2004d, *Mercury content of Illinois soils: Water, Air, and Soil Pollution*, v. 156, p. 299–315.
- Dreher, G.B., and L.R. Follmer, 2005, A progress report on the description of the geology and chemical composition of soils in Illinois: Cores 127 through 137: Champaign, Illinois State Geological Survey, Open-File Series 2005-5, 84 p.
- Dreher, G.B., L.R. Follmer, and Y. Zhang, 2002, A progress report on the chemical composition of soils in Illinois: Cores 1 through 10: Champaign, Illinois State Geological Survey, Open-File Series 2002-2, 83 p.
- Dreher, G.B., L.R. Follmer, and Y. Zhang, 2003a, A progress report on the description of the geology and chemical composition of soils in Illinois: Cores 11 through 26: Champaign, Illinois State Geological Survey, Open-File Series 2003-1, 99 p.
- Dreher, G.B., L.R. Follmer, and Y. Zhang, 2003b, A progress report on the description of the geology and chemical composition of soils in Illinois: Cores 27 through 51: Champaign, Illinois State Geological Survey, Open-File Series 2003-3, 128 p.
- Fehrenbacher, J.B., I.J. Jansen, R.G. Darmody, M.A. Flock, E.E. Voss, J.W. Scott, W.F. Andrews, and L.J. Bushue, 1984, *Soils of Illinois*: University of Illinois at Urbana-Champaign, Agricultural Experiment Station, Bulletin 778, 85 p.
- Food and Agriculture Organization of the United Nations, 2015, 2015 International Year of Soils: Rome, Food and Agriculture Organization of the United Nations, <http://www.fao.org/soils-2015/en/> (accessed December 19, 2017).
- Illinois Environmental Protection Agency (IEPA), 1994, A summary of selected background conditions for inorganics in soils: Springfield, Illinois Environmental Protection Agency, IEPA/ENV/94-161, 13 p.
- Jones, R.L., 1986, Barium in Illinois surface soils: *Soil Science Society of America Journal*, v. 50, p. 1085–1087.
- Jones, R.L., 1989, Rubidium in surface horizons of Illinois soils: *Soil Science Society of America Journal*, v. 53, p. 588–591.
- Jones, R.L., 2002, Zinc and cadmium in Illinois surface soils: *Transactions of the Illinois State Academy of Sciences*, v. 95, p. 87–97.
- Smith, D.B., W.F. Cannon, L.G. Woodruff, F. Solano, J.E. Kilburn, and D.L. Fey, 2013, *Geochemical and mineralogical data for soils of the conterminous United States*: Reston, Virginia, U.S. Geological Survey, Data Series 801, 19 p., <https://pubs.usgs.gov/ds/801/> (accessed December 19, 2017).
- Soil Survey Staff, 1999, *Soil taxonomy: A basic system of soil classification for making and interpreting soil surveys*, 2nd ed.: U.S. Department of Agriculture, Natural Resources Conservation Service, Handbook 436, 872 p.
- Zhang, Y., 2002, Quality control summary: X-ray fluorescence spectrometry analysis for major, minor, and trace elements: Champaign, Illinois State Geological Survey, unpublished report.
- Zhang, Y., and J.K. Frost, 2002, Regional distribution of selected elements in Illinois soils: Champaign, Illinois State Geological Survey, *Environmental Geology* 154, 41 p.

Electronic Filing: Received, Clerk's Office 3/24/2022



**APPENDIX 1—ANALYSIS NUMBER, COUNTY, LOCATION, FIELD IDENTIFICATION, DEPTH,  
AND ELEMENTAL CONCENTRATIONS IN ILLINOIS SOILS (ZHANG AND FROST 2002)**

Note: The following samples were not included in the statistical analysis: \*Samples were collected at the same site 30, 100, and 160 ft west of Route 47; #site was located in the Town of Lincoln; &samples are a mixture of A and B horizons; ^samples are not a native B horizon—the site contains soil from an old mine site. LOI, loss on ignition.

Analysis no.	County	Latitude	Longitude	Field ID	Depth (m)	SiO <sub>2</sub> (%)	Al <sub>2</sub> O <sub>3</sub> (%)	Fe <sub>2</sub> O <sub>3</sub> (%)
R19598	Adams	40.0235	-90.9575	80AD0408	0.1–0.2	78.10	9.49	3.55
R19599	Adams	40.0235	-90.9575	80AD2832	0.7–0.8	70.88	13.46	5.36
R19600	Adams	40.0947	-91.2823	81AD0408	0.1–0.2	83.96	6.30	1.79
R19601	Adams	40.0947	-91.2823	81AD1822	0.4–0.5	87.20	5.77	2.10
R19688	Adams	39.8920	-90.9358	82AD0408	0.1–0.2	71.94	12.10	4.81
R19689	Adams	39.8920	-90.9358	82AD2832	0.7–0.8	73.27	11.91	4.61
R19523	Boone	42.4175	-88.9205	50BO0408	0.1–0.2	79.29	8.95	2.41
R19524	Boone	42.4175	-88.9205	50BO2832	0.7–0.8	72.04	12.83	5.06
R19704	Brown	39.8893	-90.6702	90BR0408	0.1–0.2	77.18	8.97	2.77
R19705	Brown	39.8893	-90.6702	90BR2832	0.7–0.8	71.73	12.06	5.49
R18790	Bureau	41.3382	-89.2092	21BU0408	0.1–0.2	71.92	10.70	3.66
R18791	Bureau	41.3382	-89.2092	21BU2832	0.7–0.8	73.14	12.17	4.51
R18815	Bureau	41.3920	-89.4363	25BU0408	0.1–0.2	73.67	10.59	3.41
R18816	Bureau	41.3920	-89.4363	25BU2832	0.7–0.8	71.97	11.85	6.19
R19533	Carroll	42.1398	-90.1642	55CR0408	0.1–0.2	76.78	10.00	3.49
R19534	Carroll	42.1398	-90.1642	55CR2832	0.7–0.8	75.58	10.97	4.17
R19702	Cass	39.8873	-90.3730	89CS0408	0.1–0.2	68.24	7.45	2.66
R19703	Cass	39.8873	-90.3730	89CS2832	0.7–0.8	71.93	7.73	2.88
R18524	Champaign	40.0262	-88.3693	NPS50408	0.1–0.2	70.08	10.63	3.56
R18525	Champaign	40.0262	-88.3693	NPS52832	0.7–0.8	73.59	12.20	4.20
R18821	Champaign	40.3180	-88.1580	28CG0408	0.1–0.2	79.54	7.89	2.63
R18822	Champaign	40.3180	-88.1580	28CG2832	0.7–0.8	77.20	10.18	3.85
R18446	* Champaign (30 ft)	40.2035	-88.3952	01/A0408	0.1–0.2	79.72	8.33	2.54
R18447	* Champaign (30 ft)	40.2035	-88.3952	01/A2832	0.7–0.8	71.02	12.26	5.24
R18448	* Champaign (100 ft)	40.2035	-88.3952	01/B0408	0.1–0.2	79.68	8.84	2.76
R18449	* Champaign (100 ft)	40.2035	-88.3952	01/B2832	0.7–0.8	75.19	10.51	4.45
R18450	Champaign (160 ft)	40.2035	-88.3952	01/C0408	0.1–0.2	79.79	9.10	2.81
R18451	Champaign (160 ft)	40.2035	-88.3952	01/C2832	0.7–0.8	73.89	12.04	5.17
R18632	Christian	39.3738	-89.0667	CHR10408	0.1–0.2	78.72	8.95	2.81
R18633	Christian	39.3738	-89.0667	CHR12832	0.7–0.8	71.08	13.11	6.08
R19377	Christian	39.5567	-89.2708	32CT0408	0.1–0.2	78.83	8.16	2.35
R19378	Christian	39.5567	-89.2708	32CT3337	0.7–0.8	79.08	9.36	3.06
R19698	Christian	39.6352	-89.4732	87CT0408	0.1–0.2	78.55	8.93	2.64
R19699	Christian	39.6352	-89.4732	87CT2832	0.7–0.8	71.35	12.76	5.45
R19387	Clay	38.6447	-88.6553	37CY0408	0.1–0.2	78.36	9.04	3.67
R19388	Clay	38.6447	-88.6553	37CY2832	0.7–0.8	69.58	14.35	5.61
R19381	Clinton	38.4733	-89.6770	34CL0408	0.1–0.2	80.59	8.29	2.45
R19382	Clinton	38.4733	-89.6770	34CL2832	0.7–0.8	69.89	13.84	5.14
R18634	Coles	39.4690	-88.3410	COL10408	0.1–0.2	77.31	9.26	3.39
R18635	Coles	39.4690	-88.3410	COL12832	0.7–0.8	66.76	10.61	5.52
R18792	DeKalb	41.7882	-88.7595	22DK0408	0.1–0.2	74.80	10.12	3.35
R18793	DeKalb	41.7882	-88.7595	22DK2832	0.7–0.8	72.13	11.68	4.61
R19467	DuPage	41.8255	-88.0542	41DU0408	0.1–0.2	56.95	10.47	7.85
R19468	DuPage	41.8255	-88.0542	41DU2630	0.7–0.8	64.79	12.10	6.15
R19469	DuPage	41.9630	-88.0813	42DU0408	0.1–0.2	73.97	11.20	3.78
R19470	DuPage	41.9630	-88.0813	42DU2529	0.7–0.8	65.29	15.28	6.19
R18693	Franklin	38.0907	-88.9900	18FR0408	0.1–0.2	77.72	9.80	3.35
R18694	Franklin	38.0907	-88.9900	18FR2832	0.7–0.8	73.91	12.41	4.60
R18638	Fulton	40.3028	-90.1875	FUL10408	0.1–0.2	73.29	10.21	3.68
R18639	Fulton	40.3028	-90.1875	FUL12832	0.7–0.8	73.67	11.76	5.18
R18644	Fulton	40.2057	-90.3575	FUL20408	0.1–0.2	72.63	11.64	4.67
R18645	Fulton	40.2057	-90.3575	FUL22832	0.7–0.8	67.01	9.33	3.81

*Continued on next page*

# Electronic Filing: Received, Clerk's Office 3/24/2022

Analysis no.	County	Latitude	Longitude	Field ID	Depth (m)	SiO <sub>2</sub> (%)	Al <sub>2</sub> O <sub>3</sub> (%)	Fe <sub>2</sub> O <sub>3</sub> (%)
R19580	Grund	41.3580	-88.3252	71GY0408	0.1-0.2	75.52	9.20	3.37
R19581	Grund	41.3580	-88.3252	71GY2226	0.5-0.6	76.99	8.68	6.00
R19566	Hancock	40.2545	-91.1220	69HK0408	0.1-0.2	77.23	9.07	2.79
R19567	Hancock	40.2545	-91.1220	69HK2832	0.7-0.8	69.01	13.70	5.53
R19568	Hancock	40.3378	-91.4350	70HK0408	0.1-0.2	80.49	8.24	2.36
R19569	Hancock	40.3378	-91.4350	70HK2832	0.7-0.8	73.64	11.59	4.94
R19562	Henderson	40.8150	-91.0278	67HN0408	0.1-0.2	75.71	8.09	2.44
R19563	Henderson	40.8150	-91.0278	67HN2832	0.7-0.8	79.11	9.13	2.85
R19544	Henry	41.4313	-90.1147	59HY0408	0.1-0.2	77.30	8.94	2.81
R19545	Henry	41.4313	-90.1147	59HY2832	0.7-0.8	74.52	11.17	4.14
R19546	Henry	41.3157	-89.8860	60HY0408	0.1-0.2	76.29	10.34	3.38
R19547	Henry	41.3157	-89.8860	60HY2832	0.7-0.8	73.95	11.64	4.65
R19548	Henry	41.2013	-90.1188	61HY0408	0.1-0.2	72.29	11.20	4.47
R19549	Henry	41.2013	-90.1188	61HY2832	0.7-0.8	74.99	9.98	3.98
R18689	Jackson	37.7040	-89.2190	16JK0408	0.1-0.2	77.87	9.51	3.12
R18690	Jackson	37.7040	-89.2190	16JK2832	0.7-0.8	72.63	12.69	4.96
R19529	Jo Daviess	42.4483	-90.0473	53JD0408	0.1-0.2	79.21	9.09	2.38
R19530	Jo Daviess	42.4483	-90.0473	53JD2832	0.7-0.8	73.58	12.07	4.65
R19531	Jo Daviess	42.4188	-90.4155	54JD0408	0.1-0.2	73.33	11.09	3.65
R19532	Jo Daviess	42.4188	-90.4155	54JD2832	0.7-0.8	69.42	14.40	5.32
R19519	Kane	41.8633	-88.4242	48KA0408	0.1-0.2	71.93	10.30	3.44
R19520	Kane	41.8633	-88.4242	48KA2832	0.7-0.8	69.90	11.46	4.55
R19582	Kane	41.8078	-88.3223	72KA0408	0.1-0.2	66.68	10.84	4.01
R19583	Kane	41.8078	-88.3223	72KA0913	0.7-0.8	49.78	5.95	2.96
R19473	Kankakee	41.1328	-87.8353	44KK0408	0.1-0.2	82.13	6.86	2.16
R19474	Kankakee	41.1328	-87.8353	44KK2832	0.7-0.8	84.70	6.69	2.62
R19465	Kendall	41.7113	-88.2813	40KL0408	0.1-0.2	69.30	11.68	4.12
R19466	Kendall	41.7113	-88.2813	40KL2832	0.7-0.8	71.28	12.93	4.50
R19586	Knox	40.8078	-90.1485	74KX0408	0.1-0.2	72.38	9.95	3.29
R19587	Knox	40.8078	-90.1485	74KX2832	0.7-0.8	72.75	11.52	3.99
R19588	Knox	40.8022	-90.4072	75KX0408	0.1-0.2	72.61	10.16	3.23
R19589	Knox	40.8022	-90.4072	75KX2832	0.7-0.8	71.02	12.97	4.60
R19584	LaSalle	41.3188	-88.7048	73LS0408	0.1-0.2	75.59	8.21	2.92
R19585	LaSalle	41.3188	-88.7048	73LS2832	0.7-0.8	78.61	9.13	4.19
R19471	Lake	42.3425	-87.8803	43LK0408	0.1-0.2	74.70	10.30	5.11
R19472	Lake	42.3425	-87.8803	43LK2024	0.4-0.5	66.59	10.10	5.90
R19475	Lake	42.4680	-87.8688	45LK0408	0.1-0.2	70.37	11.11	4.09
R19476	Lake	42.4680	-87.8688	45LK2832	0.7-0.8	48.05	9.96	4.73
R19477	Lake	42.4625	-87.9917	46LK0408	0.1-0.2	63.38	15.89	7.21
R19478	Lake	42.4625	-87.9917	46LK2832	0.7-0.8	46.11	9.72	4.12
R18788	Livingston	40.7387	-88.5018	20LV0408	0.1-0.2	69.91	11.55	4.31
R18789	Livingston	40.7387	-88.5018	20LV2832	0.7-0.8	71.50	12.23	4.86
R18458	# Logan	40.1585	-89.3662	04/04-08	0.1-0.2	67.27	10.40	5.44
R18459	# Logan	40.1585	-89.3662	04/28-32	0.7-0.8	71.08	10.70	4.58
R19590	Logan	39.9772	-89.5467	76LO0408	0.1-0.2	72.98	10.18	4.08
R19591	Logan	39.9772	-89.5467	76LO2832	0.7-0.8	72.25	11.70	5.05
R18630	Macon	39.7090	-89.0002	MCN10408	0.1-0.2	73.70	9.63	3.67
R18631	Macon	39.7090	-89.0002	MCN12832	0.7-0.8	67.13	12.13	4.89
R18695	Marion	38.6043	-89.0557	19MN0408	0.1-0.2	81.50	7.76	2.02
R18696	Marion	38.6043	-89.0557	19MN2832	0.7-0.8	70.51	14.61	4.84
R19596	Mason	40.2980	-89.9948	79MA0408	0.1-0.2	90.34	3.84	1.06
R19597	Mason	40.2980	-89.9948	79MA2832	0.7-0.8	91.63	3.83	1.01
R19564	McDonough	40.4537	-90.8022	68MU0408	0.1-0.2	79.84	8.24	2.21
R19565	McDonough	40.4537	-90.8022	68MU2832	0.7-0.8	68.78	14.06	5.75
R19479	McHenry	42.3095	-88.2268	47MY0408	0.1-0.2	82.02	7.72	2.24
R19480	McHenry	42.3095	-88.2268	47MY2832	0.7-0.8	66.56	11.81	4.68
R19521	McHenry	42.2302	-88.5503	49MY0408	0.1-0.2	77.90	8.63	3.02
R19522	McHenry	42.2302	-88.5503	49MY2832	0.7-0.8	55.33	7.36	2.49
R18452	McLean	40.3117	-88.7332	02/04-08	0.1-0.2	73.86	9.94	3.52

*Continued on next page*



## Electronic Filing: Received, Clerk's Office 3/24/2022

Analysis no.	County	Latitude	Longitude	Field ID	Depth (m)	SiO <sub>2</sub> (%)	Al <sub>2</sub> O <sub>3</sub> (%)	Fe <sub>2</sub> O <sub>3</sub> (%)
R18453	McLean	40.3117	-88.7332	02/28-32	0.7-0.8	71.44	12.87	5.42
R18454	McLean	40.3155	-89.0020	03/A0408	0.1-0.2	77.78	9.08	3.14
R18455	& McLean	40.3155	-89.0020	03/A2630	0.7-0.8	81.35	6.55	2.69
R18456	& McLean	40.3155	-89.0020	03/B4248	1.0-1.1	73.67	10.65	3.74
R18457	McLean	40.3155	-89.0020	03/C6270	1.5-1.6	74.76	11.34	4.22
R19592	Menard	40.0008	-89.8575	77ME0408	0.1-0.2	79.55	8.55	2.68
R19593	Menard	40.0008	-89.8575	77ME2832	0.7-0.8	75.32	10.97	3.99
R19594	Menard	39.9530	-89.9628	78ME0408	0.1-0.2	76.79	8.72	2.96
R19595	Menard	39.9530	-89.9628	78ME2832	0.7-0.8	75.81	8.95	3.13
R19554	Mercer	41.1978	-90.7437	63MR0408	0.1-0.2	71.37	10.07	3.38
R19555	Mercer	41.1978	-90.7437	63MR2832	0.7-0.8	71.19	12.54	4.75
R19700	Morgan	39.6787	-90.1930	88MG0408	0.1-0.2	72.76	9.14	2.92
R19701	Morgan	39.6787	-90.1930	88MG2832	0.7-0.8	70.46	12.84	5.26
R18794	Ogle	41.9555	-88.9560	23OG0408	0.1-0.2	78.53	9.54	2.93
R18795	Ogle	41.9555	-88.9560	23OG2832	0.7-0.8	79.32	9.56	3.55
R18796	Ogle	41.9033	-89.4035	24OG0408	0.1-0.2	81.50	7.86	2.11
R18797	Ogle	41.9033	-89.4035	24OG2832	0.7-0.8	79.86	8.85	3.42
R18640	Peoria	40.5255	-89.8732	PEO10408	0.1-0.2	74.72	9.67	4.01
R18641	Peoria	40.5255	-89.8732	PEO12832	0.7-0.8	66.28	10.69	4.28
R18642	Peoria	40.6915	-89.9042	PEO20408	0.1-0.2	75.41	10.38	3.52
R18643	Peoria	40.6915	-89.9042	PEO22832	0.7-0.8	70.84	12.94	5.30
R19538	Peoria	40.7463	-89.7733	56PA0408	0.1-0.2	56.81	17.03	7.87
R19539	Peoria	40.7463	-89.7733	56PA2832	0.7-0.8	41.97	10.57	5.50
R18691	Perry	37.9718	-89.1930	17PY0408	0.1-0.2	78.72	9.16	3.29
R18692	Perry	37.9718	-89.1930	17PY2832	0.7-0.8	74.36	11.98	4.44
R19690	Pike	39.7088	-91.1610	83PK0408	0.1-0.2	73.76	9.52	3.10
R19691	Pike	39.7088	-91.1610	83PK2832	0.7-0.8	66.31	8.98	3.10
R19692	Pike	39.5600	-90.8255	84PK0408	0.1-0.2	77.44	9.12	3.03
R19693	Pike	39.5600	-90.8255	84PK2832	0.7-0.8	71.57	12.60	5.34
R18568	Rock Island	41.4530	-90.5370	311-SI-A	0.1-0.2	73.86	9.81	3.21
R18569	Rock Island	41.4530	-90.5370	311-SI-B	0.8-0.9	76.17	11.03	3.96
R19552	Rock Island	41.4297	-90.8237	62RK0408	0.1-0.2	77.48	9.60	2.74
R19553	Rock Island	41.4297	-90.8237	62RK2832	0.7-0.8	71.88	12.69	4.93
R19556	Rock Island	41.3928	-90.6238	64RK0408	0.1-0.2	71.85	9.50	3.21
R19557	Rock Island	41.3928	-90.6238	64RK2832	0.7-0.8	70.79	13.24	4.66
R19696	Sangamon	39.5817	-89.7200	86SM0408	0.1-0.2	77.70	8.34	2.67
R19697	Sangamon	39.5817	-89.7200	86SM2832	0.7-0.8	76.25	10.73	3.88
R19706	Schuyler	40.1782	-90.5712	91SU0408	0.1-0.2	74.00	9.73	3.12
R19707	Schuyler	40.1782	-90.5712	91SU2832	0.7-0.8	70.09	13.02	5.40
R19694	Scott	39.6908	-90.4630	85SO0408	0.1-0.2	75.37	9.20	3.44
R19695	Scott	39.6908	-90.4630	85SO2832	0.7-0.8	72.27	11.97	5.17
R18817	Stark	41.1750	-89.7872	26SK0408	0.1-0.2	76.64	9.80	2.80
R18818	Stark	41.1750	-89.7872	26SK2832	0.7-0.8	71.78	13.25	4.94
R19527	Stephenson	42.2788	-89.6493	52SP0408	0.1-0.2	69.84	7.19	2.45
R19528	Stephenson	42.2788	-89.6493	52SP2832	0.7-0.8	71.69	9.51	2.99
R18636	Tazewell	40.4340	-89.3022	TAZ10408	0.1-0.2	70.02	10.31	4.03
R18637	Tazewell	40.4340	-89.3022	TAZ13034	0.7-0.8	69.08	14.26	5.54
R18823	Vermilion	40.3042	-87.8723	29VE0408	0.1-0.2	68.16	10.93	4.47
R18824	Vermilion	40.3042	-87.8723	29VE2832	0.7-0.8	59.05	13.99	5.73
R19373	Vermilion	40.4593	-87.6845	30VE0408	0.1-0.2	70.14	10.37	3.92
R19374	Vermilion	40.4593	-87.6845	30VE2832	0.7-0.8	66.02	14.74	6.26
R19375	Vermilion	40.0415	-87.6360	31VE0408	0.1-0.2	73.74	9.73	3.49
R19376	^ Vermilion	40.0415	-87.6360	31VE2832	0.7-0.8	71.80	11.80	6.06
R19558	Warren	41.0680	-90.5597	65WR0408	0.1-0.2	72.61	11.41	5.25
R19559	Warren	41.0680	-90.5597	65WR2832	0.7-0.8	73.04	11.75	5.91
R19560	Warren	40.9307	-90.6263	66WR0408	0.1-0.2	79.44	8.74	2.42
R19561	Warren	40.9307	-90.6263	66WR2832	0.7-0.8	72.24	12.40	5.00
R19379	Washington	38.4000	-89.5167	33WA0408	0.1-0.2	77.90	9.23	3.56
R19380	Washington	38.4000	-89.5167	33WA2832	0.7-0.8	70.54	12.87	5.61

*Continued on next page*

Electronic Filing: Received, Clerk's Office 3/24/2022

Analysis no.	County	Latitude	Longitude	Field ID	Depth (m)	SiO <sub>2</sub> (%)	Al <sub>2</sub> O <sub>3</sub> (%)	Fe <sub>2</sub> O <sub>3</sub> (%)
R19383	Washington	38.3347	-89.2382	35WA0408	0.1-0.2	81.60	8.18	2.58
R19384	Washington	38.3347	-89.2382	35WA2832	0.7-0.8	81.05	8.61	3.38
R19385	Washington	38.4270	-89.1652	36WA0408	0.1-0.2	81.25	7.54	2.47
R19386	Washington	38.4270	-89.1652	36WA2832	0.7-0.8	69.63	14.15	5.67
R19540	Whiteside	41.6730	-89.9308	57WS0408	0.1-0.2	66.61	8.99	4.20
R19541	Whiteside	41.6730	-89.9308	57WS2832	0.7-0.8	67.84	9.66	4.12
R19542	Whiteside	41.8422	-89.9662	58WS0408	0.1-0.2	76.90	9.59	3.03
R19543	Whiteside	41.8422	-89.9662	58WS2832	0.7-0.8	73.22	11.96	4.52
R19461	Will	41.4267	-87.7538	38WL0408	0.1-0.2	72.70	11.13	4.10
R19462	Will	41.4267	-87.7538	38WL2832	0.7-0.8	61.08	13.91	5.31
R19463	Will	41.5038	-87.8800	39WL0408	0.1-0.2	76.63	9.84	3.34
R19464	Will	41.5038	-87.8800	39WL2832	0.7-0.8	61.18	13.51	5.55
R18687	Williamson	37.7500	-89.1178	15WM0408	0.1-0.2	78.56	8.72	3.78
R18688	Williamson	37.7500	-89.1178	15WM2832	0.7-0.8	71.64	13.24	4.93
R19525	Winnebago	42.2772	-89.1792	51WN0408	0.1-0.2	80.22	7.98	2.73
R19526	Winnebago	42.2772	-89.1792	51WN2832	0.7-0.8	75.48	11.32	3.89
R18819	Woodford	40.7753	-89.3922	27WF0408	0.1-0.2	67.33	10.60	4.25
R18820	Woodford	40.7753	-89.3922	27WF2832	0.7-0.8	66.51	10.65	4.31
Quality control replicate samples								
R19536	Kane			REP10408	0.33	72.36	10.04	3.42
R19519		41.8633	-88.4242	48KA0408	0.33	71.93	10.30	3.44
R19537	Kane			REP12832	2.33	69.82	11.15	4.49
R19520		41.8633	-88.4242	48KA2832	2.33	69.90	11.46	4.55
R19550	Henry			REP20408	0.33	76.41	10.34	3.39
R19546		41.3157	-89.8860	60HY0408	0.33	76.29	10.34	3.38
R19551	Henry			REP22832	2.33	73.88	11.62	4.66
R19547		41.3157	-89.8860	60HY2832	2.33	73.95	11.64	4.65
R19686	Logan			REP30408	0.33	72.77	10.28	4.11
R19590		39.9772	-89.5467	76LO0408	0.33	72.98	10.18	4.08
R19687	Logan			REP32832	2.33	71.90	11.74	5.07
R19591		39.9772	-89.5467	76LO2832	2.33	72.25	11.70	5.05

Continued on next page

Electronic Filing: Received, Clerk's Office 3/24/2022

Analysis no.	County	MgO (%)	CaO (%)	Na <sub>2</sub> O (%)	K <sub>2</sub> O (%)	TiO <sub>2</sub> (%)	P <sub>2</sub> O <sub>5</sub> (%)	MnO (%)	LOI (%)
R19598	Adams	0.54	0.50	0.67	1.60	0.78	0.08	0.09	4.25
R19599	Adams	0.99	0.42	0.70	2.00	0.84	0.06	0.04	4.59
R19600	Adams	0.37	0.52	0.76	1.38	0.59	0.06	0.06	3.96
R19601	Adams	0.35	0.27	0.42	0.93	0.50	0.04	0.02	2.26
R19688	Adams	1.12	0.65	0.97	2.30	0.78	0.12	0.06	4.17
R19689	Adams	1.11	0.61	1.10	2.37	0.80	0.10	0.08	3.41
R19523	Boone	0.59	0.48	1.20	2.25	0.76	0.10	0.19	3.26
R19524	Boone	1.17	0.64	1.07	2.25	0.70	0.14	0.11	3.56
R19704	Brown	0.64	0.83	1.11	2.32	0.77	0.12	0.15	4.43
R19705	Brown	1.10	0.64	0.89	2.33	0.74	0.12	0.12	4.15
R18790	Bureau	0.94	1.05	1.05	2.04	0.70	0.13	0.12	6.62
R18791	Bureau	1.06	0.87	1.19	2.06	0.70	0.12	0.11	3.50
R18815	Bureau	0.83	0.90	1.12	2.05	0.71	0.14	0.09	6.14
R18816	Bureau	1.01	0.98	1.22	1.91	0.66	0.13	0.10	3.76
R19533	Carroll	0.63	0.83	1.38	2.02	0.77	0.08	0.10	3.31
R19534	Carroll	0.84	1.00	1.58	2.10	0.74	0.13	0.08	2.29
R19702	Cass	3.13	4.59	1.16	2.12	0.56	0.13	0.07	9.31
R19703	Cass	2.61	4.13	1.12	2.03	0.52	0.09	0.06	6.56
R18524	Champaign	1.01	1.17	0.86	2.17	0.68	0.16	0.05	9.06
R18525	Champaign	1.27	0.84	0.93	2.31	0.72	0.09	0.08	4.02
R18821	Champaign	0.59	0.39	0.74	2.14	0.46	0.08	0.06	4.68
R18822	Champaign	0.98	0.23	0.68	2.69	0.49	0.05	0.06	3.15
R18446	* Champaign (30 ft)	0.54	0.52	1.01	2.14	0.76	0.11	0.16	3.89
R18447	* Champaign (30 ft)	1.08	0.58	0.86	2.25	0.71	0.08	0.10	4.47
R18448	* Champaign (100 ft)	0.57	0.48	1.01	2.15	0.78	0.10	0.17	3.81
R18449	* Champaign (100 ft)	0.93	0.51	0.89	2.27	0.58	0.07	0.08	3.20
R18450	Champaign (160 ft)	0.61	0.48	1.02	2.14	0.81	0.09	0.18	3.75
R18451	Champaign (160 ft)	1.05	0.60	1.01	2.28	0.73	0.08	0.08	3.71
R18632	Christian	0.49	0.57	1.12	1.86	0.77	0.08	0.07	4.22
R18633	Christian	1.07	0.89	1.01	1.93	0.75	0.13	0.04	3.98
R19377	Christian	0.45	0.54	1.06	2.07	0.72	0.11	0.12	5.02
R19378	Christian	0.61	0.40	0.90	2.01	0.60	0.11	0.11	3.22
R19698	Christian	0.56	0.50	1.08	2.35	0.80	0.10	0.17	3.71
R19699	Christian	1.17	0.57	0.86	2.33	0.77	0.12	0.08	4.11
R19387	Clay	0.48	0.11	0.90	1.57	0.81	0.09	0.27	4.06
R19388	Clay	1.10	0.20	0.90	1.86	0.83	0.09	0.06	4.89
R19381	Clinton	0.43	0.47	1.20	1.84	0.75	0.09	0.18	3.42
R19382	Clinton	1.32	0.83	0.97	1.97	0.72	0.06	0.14	4.55
R18634	Coles	0.70	0.56	0.78	2.22	0.57	0.15	0.08	4.35
R18635	Coles	2.30	3.05	0.67	2.69	0.55	0.07	0.07	6.77
R18792	DeKalb	0.81	0.79	0.97	2.07	0.72	0.18	0.14	5.97
R18793	DeKalb	1.02	0.62	0.85	2.08	0.68	0.11	0.15	5.82
R19467	DuPage	2.08	2.78	0.68	2.15	0.55	0.28	0.08	15.53
R19468	DuPage	1.21	1.16	0.83	2.40	0.63	0.14	0.03	9.69
R19469	DuPage	0.94	0.39	0.88	3.01	0.78	0.10	0.11	4.55
R19470	DuPage	2.01	0.67	0.67	4.01	0.72	0.11	0.09	4.66
R18693	Franklin	0.61	0.15	0.91	1.93	0.82	0.09	0.16	4.01
R18694	Franklin	0.96	0.32	1.10	1.99	0.79	0.07	0.04	3.55
R18638	Fulton	0.81	0.71	1.02	2.20	0.73	0.11	0.13	5.41
R18639	Fulton	1.08	0.75	1.10	2.28	0.72	0.13	0.08	3.30
R18644	Fulton	0.95	0.66	0.97	2.26	0.76	0.13	0.09	4.53
R18645	Fulton	3.25	4.55	1.33	2.05	0.69	0.13	0.09	7.37
R19580	Grundy	0.51	0.49	0.60	2.12	0.57	0.17	0.06	6.54
R19581	Grundy	0.29	0.26	0.51	2.11	0.52	0.13	0.16	3.70
R19566	Hancock	0.58	1.02	1.23	1.88	0.77	0.08	0.10	4.52
R19567	Hancock	1.32	0.93	1.10	1.90	0.73	0.12	0.34	4.63
R19568	Hancock	0.45	0.83	1.36	2.09	0.75	0.09	0.17	2.83
R19569	Hancock	1.02	0.85	1.26	2.06	0.69	0.13	0.06	3.26
R19562	Henderson	0.83	2.05	1.18	1.77	0.51	0.16	0.06	6.46

Continued on next page

## Electronic Filing: Received, Clerk's Office 3/24/2022

Analysis no.	County	MgO (%)	CaO (%)	Na <sub>2</sub> O (%)	K <sub>2</sub> O (%)	TiO <sub>2</sub> (%)	P <sub>2</sub> O <sub>5</sub> (%)	MnO (%)	LOI (%)
R19563	Henderson	0.73	1.06	1.31	1.86	0.57	0.11	0.06	2.70
R19544	Henry	0.60	0.73	1.01	1.91	0.66	0.15	0.12	5.30
R19545	Henry	1.01	0.71	1.08	1.90	0.65	0.09	0.07	3.66
R19546	Henry	0.71	0.61	1.11	2.17	0.76	0.07	0.11	3.77
R19547	Henry	0.99	0.78	1.18	2.22	0.77	0.12	0.06	3.27
R19548	Henry	1.04	1.00	1.15	2.10	0.72	0.12	0.10	4.99
R19549	Henry	1.24	1.38	1.20	2.14	0.71	0.13	0.09	3.30
R18689	Jackson	0.57	0.43	0.95	1.95	0.77	0.15	0.22	4.07
R18690	Jackson	1.02	0.32	1.07	2.09	0.76	0.12	0.07	3.62
R19529	Jo Daviess	0.58	0.50	1.21	2.12	0.77	0.10	0.13	3.22
R19530	Jo Daviess	1.00	0.48	1.00	2.31	0.82	0.11	0.10	3.22
R19531	Jo Daviess	1.11	1.01	1.11	2.06	0.70	0.09	0.12	4.67
R19532	Jo Daviess	1.43	0.77	1.05	2.08	0.70	0.11	0.06	4.11
R19519	Kane	0.85	0.80	0.88	1.99	0.69	0.13	0.12	8.36
R19520	Kane	1.93	1.87	0.88	2.29	0.60	0.07	0.10	5.51
R19582	Kane	1.54	1.86	0.84	2.24	0.69	0.16	0.11	10.14
R19583	Kane	7.75	11.21	0.63	1.54	0.36	0.10	0.08	18.85
R19473	Kankakee	0.50	0.54	0.69	1.64	0.38	0.13	0.09	4.85
R19474	Kankakee	0.47	0.21	0.63	1.53	0.30	0.05	0.04	2.16
R19465	Kendall	1.07	0.82	0.86	2.28	0.73	0.15	0.09	8.25
R19466	Kendall	1.37	1.03	1.04	2.20	0.73	0.13	0.07	4.33
R19586	Knox	0.75	0.89	1.01	2.31	0.74	0.19	0.18	7.78
R19587	Knox	0.95	0.67	0.98	2.31	0.76	0.10	0.14	5.19
R19588	Knox	0.82	1.12	1.04	1.96	0.71	0.13	0.10	7.61
R19589	Knox	1.28	0.96	1.02	2.02	0.72	0.10	0.11	4.48
R19584	LaSalle	0.87	0.99	0.85	1.76	0.69	0.12	0.03	7.66
R19585	LaSalle	0.43	0.17	0.98	1.93	0.79	0.05	0.07	3.01
R19471	Lake	0.99	0.61	0.86	2.34	0.61	0.08	0.15	3.80
R19472	Lake	2.76	2.92	0.72	2.67	0.48	0.10	0.18	6.93
R19475	Lake	1.28	0.72	0.67	3.22	0.73	0.10	0.09	7.18
R19476	Lake	6.59	9.80	0.51	2.88	0.54	0.08	0.09	16.21
R19477	Lake	2.18	0.62	0.58	3.98	0.71	0.09	0.12	5.22
R19478	Lake	6.74	11.35	0.56	2.81	0.50	0.08	0.08	17.21
R18788	Livingston	1.18	1.03	0.72	2.55	0.68	0.18	0.07	8.08
R18789	Livingston	1.34	0.77	0.77	2.67	0.72	0.10	0.11	4.49
R18458	# Logan	1.23	2.60	0.91	2.01	0.65	0.14	0.13	8.85
R18459	# Logan	1.91	2.18	1.14	2.28	0.70	0.13	0.09	5.05
R19590	Logan	0.82	0.85	0.87	2.35	0.73	0.19	0.11	5.97
R19591	Logan	1.04	0.62	0.89	2.46	0.73	0.10	0.10	4.45
R18630	Macon	0.86	1.10	0.88	2.07	0.71	0.12	0.10	7.31
R18631	Macon	2.06	2.61	0.83	2.16	0.70	0.08	0.13	6.53
R18695	Marion	0.33	0.58	0.98	1.55	0.74	0.21	0.12	3.66
R18696	Marion	0.86	0.33	0.78	1.46	0.76	0.10	0.04	5.32
R19596	Mason	0.20	0.42	0.59	1.24	0.18	0.05	0.04	1.18
R19597	Mason	0.19	0.40	0.61	1.27	0.17	0.04	0.03	0.59
R19564	McDonough	0.47	0.64	1.20	2.05	0.78	0.09	0.20	3.66
R19565	McDonough	1.34	0.68	0.87	1.95	0.72	0.11	0.12	4.86
R19479	McHenry	0.56	0.35	0.87	2.20	0.59	0.07	0.11	2.66
R19480	McHenry	2.90	2.71	0.65	2.77	0.56	0.11	0.08	6.76
R19521	McHenry	0.74	0.61	0.72	2.33	0.49	0.12	0.07	4.95
R19522	McHenry	6.33	9.49	0.62	2.34	0.37	0.09	0.05	14.88
R18452	McLean	0.75	0.80	0.91	2.22	0.74	0.22	0.13	6.74
R18453	McLean	1.18	0.66	0.92	2.26	0.75	0.07	0.10	4.67
R18454	McLean	0.66	0.63	0.93	2.13	0.67	0.12	0.09	4.94
R18455	& McLean	1.08	1.54	0.79	1.81	0.36	0.08	0.04	3.96
R18456	& McLean	0.73	0.49	0.90	2.40	0.77	0.19	0.20	6.36
R18457	McLean	0.86	0.42	0.92	2.38	0.78	0.16	0.24	4.04
R19592	Menard	0.49	0.73	1.18	2.40	0.77	0.08	0.08	3.29
R19593	Menard	0.82	0.70	1.20	2.31	0.79	0.07	0.06	2.88

*Continued on next page*

Electronic Filing: Received, Clerk's Office 3/24/2022

Analysis no.	County	MgO (%)	CaO (%)	Na <sub>2</sub> O (%)	K <sub>2</sub> O (%)	TiO <sub>2</sub> (%)	P <sub>2</sub> O <sub>5</sub> (%)	MnO (%)	LOI (%)
R19594	Menard	0.86	1.21	1.08	2.16	0.67	0.13	0.08	5.19
R19595	Menard	1.06	1.42	1.13	2.20	0.68	0.12	0.09	4.85
R19554	Mercer	0.74	0.87	1.05	2.07	0.71	0.17	0.12	8.83
R19555	Mercer	1.17	0.78	1.00	2.09	0.73	0.10	0.10	5.00
R19700	Morgan	0.74	1.03	0.96	2.17	0.73	0.16	0.15	8.62
R19701	Morgan	1.23	0.62	0.81	2.13	0.73	0.08	0.09	5.50
R18794	Ogle	0.64	0.51	0.95	2.14	0.66	0.19	0.14	3.39
R18795	Ogle	0.78	0.38	0.82	1.95	0.50	0.09	0.06	2.77
R18796	Ogle	0.47	0.44	1.05	2.05	0.66	0.14	0.14	3.24
R18797	Ogle	0.72	0.40	0.70	1.71	0.49	0.13	0.07	2.63
R18640	Peoria	0.70	0.72	0.91	2.11	0.64	0.16	0.13	5.97
R18641	Peoria	1.17	6.08	0.78	2.23	0.59	0.16	0.11	7.87
R18642	Peoria	0.72	0.61	1.06	2.19	0.80	0.13	0.14	4.45
R18643	Peoria	1.20	0.57	0.97	2.19	0.77	0.09	0.09	3.96
R19538	Peoria	1.74	1.20	0.98	3.14	0.87	0.24	0.17	8.70
R19539	Peoria	3.33	15.40	0.59	2.45	0.58	0.27	0.27	17.62
R18691	Perry	0.55	0.52	0.95	1.60	0.78	0.08	0.18	4.20
R18692	Perry	0.92	0.59	1.21	2.03	0.78	0.07	0.05	3.32
R19690	Pike	1.60	2.65	1.63	1.99	0.63	0.13	0.08	4.36
R19691	Pike	3.37	5.50	1.47	1.92	0.58	0.16	0.08	7.63
R19692	Pike	0.62	1.18	1.12	2.13	0.78	0.09	0.12	3.90
R19693	Pike	1.13	0.58	1.04	2.19	0.79	0.11	0.05	3.92
R18568	Rock Island	0.75	1.54	0.89	1.80	0.67	0.15	0.06	7.81
R18569	Rock Island	0.73	0.80	0.96	1.95	0.77	0.08	0.13	3.52
R19552	Rock Island	0.63	0.68	1.26	2.26	0.77	0.10	0.20	3.39
R19553	Rock Island	1.22	0.76	1.11	2.11	0.70	0.13	0.08	3.70
R19556	Rock Island	0.71	1.20	1.05	2.04	0.71	0.15	0.16	8.74
R19557	Rock Island	1.29	0.84	1.00	2.02	0.71	0.09	0.08	4.60
R19696	Sangamon	0.53	0.81	1.04	2.13	0.74	0.13	0.13	5.16
R19697	Sangamon	0.77	0.67	0.92	1.87	0.66	0.07	0.08	3.61
R19706	Schuyler	0.79	0.95	0.98	2.10	0.75	0.15	0.12	6.65
R19707	Schuyler	1.32	0.79	0.90	2.01	0.74	0.08	0.12	4.94
R19694	Scott	0.67	0.85	1.04	2.31	0.77	0.13	0.13	5.10
R19695	Scott	1.11	0.66	0.97	2.47	0.79	0.12	0.10	4.01
R18817	Stark	0.65	0.60	1.16	2.28	0.78	0.13	0.26	4.43
R18818	Stark	1.18	0.61	1.03	2.11	0.72	0.13	0.08	3.72
R19527	Stephenson	2.83	4.34	0.85	1.69	0.47	0.20	0.09	9.40
R19528	Stephenson	1.82	2.53	1.07	1.99	0.65	0.16	0.10	7.18
R18636	Tazewell	0.92	0.84	0.88	2.11	0.70	0.13	0.14	9.49
R18637	Tazewell	1.39	0.52	0.74	2.04	0.74	0.08	0.07	5.32
R18823	Vermilion	1.36	1.21	0.70	2.68	0.74	0.12	0.11	9.25
R18824	Vermilion	3.72	3.29	0.61	3.52	0.72	0.08	0.10	8.29
R19373	Vermilion	1.01	0.77	0.66	2.77	0.72	0.12	0.10	8.79
R19374	Vermilion	1.91	0.31	0.50	4.18	0.79	0.06	0.10	4.55
R19375	Vermilion	0.71	0.80	0.96	2.07	0.73	0.12	0.12	7.06
R19376	^ Vermilion	1.13	0.81	1.02	2.18	0.71	0.11	0.11	3.93
R19558	Warren	0.78	0.47	0.73	1.80	0.66	0.10	0.09	5.52
R19559	Warren	0.90	0.50	0.84	1.97	0.66	0.11	0.12	4.04
R19560	Warren	0.54	0.73	1.30	2.17	0.78	0.07	0.15	3.09
R19561	Warren	1.16	0.67	1.10	2.16	0.74	0.14	0.10	3.74
R19379	Washington	0.52	0.73	1.33	1.68	0.74	0.11	0.15	3.69
R19380	Washington	1.12	0.90	1.66	2.05	0.72	0.16	0.23	3.72
R19383	Washington	0.39	0.33	1.05	1.64	0.72	0.08	0.13	2.91
R19384	Washington	0.42	0.27	0.89	1.56	0.67	0.08	0.13	2.50
R19385	Washington	0.35	0.46	1.05	1.51	0.76	0.12	0.19	3.92
R19386	Washington	1.08	0.44	1.07	1.75	0.75	0.10	0.11	4.78
R19540	Whiteside	1.98	4.24	0.98	1.80	0.58	0.22	0.10	9.80
R19541	Whiteside	1.81	3.38	0.96	1.93	0.62	0.20	0.11	8.75
R19542	Whiteside	0.70	0.87	1.32	2.17	0.75	0.12	0.16	3.80

Continued on next page

Electronic Filing: Received, Clerk's Office 3/24/2022

Analysis no.	County	MgO (%)	CaO (%)	Na <sub>2</sub> O (%)	K <sub>2</sub> O (%)	TiO <sub>2</sub> (%)	P <sub>2</sub> O <sub>5</sub> (%)	MnO (%)	LOI (%)
R19543	Whiteside	1.05	0.86	1.22	2.12	0.70	0.16	0.09	3.56
R19461	Will	0.95	0.45	0.78	2.72	0.72	0.11	0.10	5.97
R19462	Will	3.11	3.45	0.69	3.33	0.66	0.08	0.08	7.64
R19463	Will	0.76	0.29	0.85	2.66	0.76	0.10	0.13	4.23
R19464	Will	3.27	3.38	0.66	3.53	0.65	0.08	0.09	7.97
R18687	Williamson	0.48	0.19	1.05	1.83	0.79	0.13	0.30	3.28
R18688	Williamson	1.02	0.25	1.08	2.05	0.77	0.11	0.05	3.83
R19525	Winnebago	0.55	0.35	0.68	1.73	0.55	0.09	0.09	4.54
R19526	Winnebago	0.86	0.44	0.87	1.96	0.69	0.08	0.08	3.69
R18819	Woodford	2.61	3.44	0.93	2.23	0.67	0.09	0.09	7.48
R18820	Woodford	2.77	3.95	0.94	2.35	0.64	0.10	0.09	7.28
Quality control replicate samples									
R19536	Kane	0.88	0.94	0.85	2.02	0.69	0.13	0.12	8.08
R19519		0.85	0.80	0.88	1.99	0.69	0.13	0.12	8.36
R19537	Kane	2.04	2.00	0.86	2.29	0.60	0.07	0.10	5.92
R19520		1.93	1.87	0.88	2.29	0.60	0.07	0.10	5.51
R19550	Henry	0.71	0.61	1.09	2.17	0.77	0.07	0.11	3.86
R19546		0.71	0.61	1.11	2.17	0.76	0.07	0.11	3.77
R19551	Henry	0.99	0.78	1.16	2.21	0.76	0.11	0.06	3.41
R19547		0.99	0.78	1.18	2.22	0.77	0.12	0.06	3.27
R19686	Logan	0.86	0.86	0.89	2.36	0.73	0.20	0.11	5.91
R19590		0.82	0.85	0.87	2.35	0.73	0.19	0.11	5.97
R19687	Logan	1.08	0.62	0.92	2.49	0.74	0.09	0.10	4.40
R19591		1.04	0.62	0.89	2.46	0.73	0.10	0.10	4.45

*Continued on next page*



## Electronic Filing: Received, Clerk's Office 3/24/2022

Analysis no.	County	Tot. C (%)	Inc. C (%)	Org. C (%)	Ag	As	B	Ba	Be	Br	Cd	Ce	Co	Cr
R19598	Adams	0.98	0.02	0.96	<1	7.4	27	365	1.0	4.5	<4	71	12.0	56
R19599	Adams	0.40	0.01	0.39	<1	9.6	37	420	1.2	2.4	<4	79	12.0	74
R19600	Adams	1.58	0.02	1.56	<1	4.5	23	410	1.1	6.1	<4	53	7.2	42
R19601	Adams	0.35	0.01	0.34	<1	5.5	33	245	<1	3.0	<4	44	5.5	44
R19688	Adams	0.67	0.03	0.64	<1	13.0	32	605	1.6	2.2	<3	74	12.0	69
R19689	Adams	0.44	0.02	0.42	<1	12.0	30	605	1.4	2.0	<3	84	14.0	70
R19523	Boone	1.07	0.04	1.03	<1	5.2	58	725	1.7	3.5	<3	66	12.0	54
R19524	Boone	0.30	0.03	0.27	<1	12.0	62	665	2.3	2.0	<3	81	13.0	69
R19704	Brown	1.52	0.06	1.46	<1	8.2	37	640	1.4	6.1	<3	76	13.0	59
R19705	Brown	0.58	0.02	0.56	<1	16.0	24	530	1.4	5.4	<3	80	14.0	72
R18790	Bureau	2.39	0.21	2.18	<1	9.5	54	690	1.5	10.0	<3	72	11.0	61
R18791	Bureau	0.48	0.23	0.25	<1	12.0	48	635	1.9	6.1	<3	78	12.0	69
R18815	Bureau	2.16	0.21	1.95	<1	9.2	59	660	1.1	8.7	<3	66	9.9	60
R18816	Bureau	0.49	0.13	0.36	<1	21.0	50	610	1.8	6.2	<3	85	14.0	67
R19533	Carroll	0.91	0.02	0.89	<1	7.5	41	655	1.2	3.5	<2	65	8.4	59
R19534	Carroll	0.70	0.02	0.68	<1	7.9	39	650	1.4	1.6	<2	71	9.8	62
R19702	Cass	3.15	1.49	1.66	<1	5.3	17	410	1.0	10.0	<3	47	6.5	45
R19703	Cass	2.71	1.28	1.43	<1	5.3	27	450	1.2	5.4	<3	46	7.1	46
R18524	Champaign	3.64	0.10	3.54	<1	8.1	44	562	1.0	9.0	<3	70	7.8	59
R18525	Champaign	0.65	0.11	0.54	<1	8.4	52	619	1.2	2.0	<4	80	11.0	68
R18821	Champaign	1.87	0.16	1.71	<1	6.8	40	470	1.0	7.1	<3	46	7.9	39
R18822	Champaign	0.66	0.16	0.50	<1	8.9	50	405	1.1	3.7	<3	55	10.0	51
R18446	* Champaign (30 ft)	1.34	0.08	1.26	<1	6.8	58	585	<1	4.4	<4	71	13.0	55
R18447	* Champaign (30 ft)	0.61	0.07	0.54	<1	15.0	58	582	<1	4.0	<3	79	13.0	69
R18448	* Champaign (100 ft)	1.10	0.12	0.98	<1	8.2	61	629	1.0	3.7	<4	74	15.0	58
R18449	* Champaign (100 ft)	0.34	0.15	0.19	<1	12.0	57	494	1.0	2.0	<4	62	11.0	58
R18450	Champaign (160 ft)	1.10	0.08	1.02	<1	8.2	49	655	<1	3.5	<4	74	14.0	56
R18451	Champaign (160 ft)	0.34	0.12	0.22	<1	15.0	58	535	1.2	3.0	<4	73	11.0	64
R18632	Christian	1.38	0.10	1.28	<1	7.5	56	610	<1	5.8	<2	66	8.3	53
R18633	Christian	0.34	0.09	0.25	<1	11.0	50	670	1.0	3.0	<2	75	7.6	75
R19377	Christian	1.17	0.04	1.13	<1	7.0	49	580	<1	5.0	<3	67	8.6	49
R19378	Christian	0.72	0.02	0.70	<1	8.3	36	700	<1	4.4	<3	56	10.0	47
R19698	Christian	1.10	0.03	1.07	<1	7.9	50	640	1.5	4.6	<3	79	14.0	60
R19699	Christian	0.33	0.02	0.31	<1	16.0	40	580	1.5	1.7	<3	86	15.0	75
R19387	Clay	1.04	0.02	1.02	<1	13.0	51	620	1.4	3.9	<3	74	16.0	58
R19388	Clay	0.61	0.02	0.59	<1	12.0	48	510	2.0	4.6	<3	77	11.0	74
R19381	Clinton	1.12	0.02	1.10	<1	7.7	51	685	1.1	5.9	<3	70	9.7	53
R19382	Clinton	0.58	0.06	0.52	<1	13.0	52	770	1.6	3.1	<3	79	15.0	75
R18634	Coles	1.43	0.15	1.28	<1	9.4	52	470	<1	6.2	<2	61	9.7	53
R18635	Coles	1.42	1.04	0.38	<1	11.0	70	390	<1	5.8	<2	64	10.0	55
R18792	DeKalb	2.07	0.16	1.91	<1	8.2	51	660	2.3	8.8	<3	69	11.0	56
R18793	DeKalb	1.70	0.13	1.57	<1	11.0	57	600	1.6	15.0	<3	75	16.0	62
R19467	DuPage	7.52	0.60	6.92	<1	17.0	68	440	2.0	10.0	<3	61	13.0	58
R19468	DuPage	4.42	0.06	4.36	<1	12.0	62	545	2.2	4.0	<3	64	9.2	64
R19469	DuPage	1.89	0.03	1.86	<1	9.5	59	625	1.6	5.1	<3	69	16.0	59
R19470	DuPage	1.22	0.08	1.14	<1	15.0	79	535	2.8	4.0	<3	80	19.0	80
R18693	Franklin	1.06	0.04	1.02	<1	10.0	47	605	1.0	3.5	<2.5	77	14.0	61
R18694	Franklin	0.27	0.18	0.09	<1	11.0	42	655	1.1	2.3	<2.5	78	8.2	68
R18638	Fulton	1.71	0.15	1.56	<1	11.0	44	630	<1	7.0	<2.5	78	12.0	59
R18639	Fulton	0.42	0.21	0.21	<1	15.0	45	530	<1	4.1	<2.5	77	11.0	67
R18644	Fulton	0.78	0.10	0.68	<1	14.0	56	550	1.2	3.0	<2.5	80	13.0	65
R18645	Fulton	—	1.67	—	<1	8.8	33	520	1.0	3.0	<2.6	63	9.1	55
R19580	Grundy	2.80	0.03	2.77	<1	9.7	21	400	1.1	12.0	<4	59	8.1	40
R19581	Grundy	0.65	0.02	0.63	<1	14.0	39	325	1.2	3.6	<4	57	17.0	34
R19566	Hancock	1.51	0.05	1.46	<1	7.8	47	595	1.7	6.0	<2	72	8.7	58
R19567	Hancock	0.48	0.02	0.46	<1	14.0	49	705	1.4	1.0	<2	104	19.0	77
R19568	Hancock	0.86	0.02	0.84	<1	5.4	37	570	1.2	2.5	<3	68	9.4	55
R19569	Hancock	0.31	0.02	0.29	<1	13.0	45	545	1.5	1.0	<2	72	8.8	65
R19562	Henderson	2.47	0.27	2.20	<1	3.1	25	445	1.0	8.4	<2	50	6.2	45

*Continued on next page*

## Electronic Filing: Received, Clerk's Office 3/24/2022

Analysis no.	County	Tot. C (%)	Inc. C (%)	Org. C (%)	Ag	As	B	Ba	Be	Br	Cd	Ce	Co	Cr
R19563	Henderson	0.60	0.02	0.58	<1	3.3	29	455	1.1	3.4	<3	57	7.1	56
R19544	Henry	1.80	0.04	1.76	<1	7.0	38	585	1.0	7.6	<2	61	8.7	53
R19545	Henry	0.43	0.03	0.40	<1	11.0	45	570	1.3	4.2	<2	66	11.0	67
R19546	Henry	0.83	0.03	0.80	<1	8.5	32	565	1.0	3.9	<2	73	12.0	64
R19547	Henry	0.30	0.02	0.28	<1	11.0	31	505	1.1	1.8	<3	75	11.0	66
R19548	Henry	1.24	0.03	1.21	<1	13.0	42	575	1.0	4.1	<2	80	12.0	68
R19549	Henry	0.49	0.20	0.29	<1	11.0	46	565	<1	2.0	<3	74	11.0	63
R18689	Jackson	1.26	0.07	1.19	<1	8.7	43	675	1.3	4.5	<2.5	79	14.0	59
R18690	Jackson	0.34	0.30	0.04	<1	14.0	42	575	1.1	2.0	<2.5	69	9.1	71
R19529	Jo Daviess	0.99	0.03	0.96	<1	5.4	43	720	1.8	3.5	<2	65	10.0	54
R19530	Jo Daviess	0.28	0.02	0.26	<1	11.0	40	600	1.8	2.4	<3	76	12.0	62
R19531	Jo Daviess	1.19	0.16	1.03	<1	8.1	43	590	1.5	3.0	<2	64	13.0	63
R19532	Jo Daviess	0.37	0.03	0.34	<1	10.0	49	700	2.1	1.0	<2	80	11.0	73
R19519	Kane	3.48	0.03	3.45	<1	7.5	43	630	1.4	13.0	<2	66	9.6	56
R19520	Kane	1.26	0.49	0.77	<1	10.0	51	595	2.2	7.3	<2	68	12.0	63
R19582	Kane	4.09	0.30	3.79	<1	9.1	48	515	1.3	12.0	<4	69	11.0	61
R19583	Kane	5.42	4.43	0.99	<1	9.2	22	270	1.0	7.4	<4	35	7.8	36
R19473	Kankakee	2.05	0.05	2.00	<1	6.6	32	440	1.0	7.0	<3	39	7.4	34
R19474	Kankakee	0.55	0.03	0.52	<1	8.0	32	325	1.1	3.7	<3	29	5.7	37
R19465	Kendall	3.16	0.05	3.11	<1	12.0	51	575	1.7	11.0	<3	74	12.0	61
R19466	Kendall	0.98	0.03	0.95	<1	8.3	67	610	2.2	4.0	<3	77	11.0	72
R19586	Knox	3.15	0.02	3.13	<1	8.3	46	700	1.3	11.0	<4	72	11.0	58
R19587	Knox	1.31	0.02	1.29	<1	11.0	49	695	1.2	11.0	<4	79	14.0	69
R19588	Knox	2.95	0.03	2.92	<1	6.7	44	630	1.4	10.0	<4	72	7.6	61
R19589	Knox	0.62	0.02	0.60	<1	9.8	52	530	1.3	3.5	<4	80	14.0	74
R19584	LaSalle	3.14	0.30	2.84	<1	8.1	37	290	1.2	4.8	<4	53	4.7	40
R19585	LaSalle	0.51	0.03	0.48	<1	9.9	53	290	1.3	1.5	<4	70	7.4	44
R19471	Lake	1.03	0.03	1.00	<1	12.0	68	395	1.6	6.2	<3	60	13.0	61
R19472	Lake	1.71	1.01	0.70	<1	16.0	57	310	1.9	5.6	<3	57	12.0	59
R19475	Lake	2.65	0.09	2.56	<1	8.7	69	475	1.8	9.4	<2	66	15.0	63
R19476	Lake	4.13	3.62	0.51	<1	9.7	59	310	1.2	4.0	<3	53	13.0	56
R19477	Lake	0.91	0.05	0.86	<1	14.0	67	495	2.8	6.0	<3	86	19.0	88
R19478	Lake	4.40	4.06	0.34	<1	8.6	67	330	1.9	2.4	<3	52	13.0	55
R18788	Livingston	3.06	0.18	2.88	<1	8.2	70	530	1.6	7.5	<3.5	69	9.3	61
R18789	Livingston	1.13	0.19	0.94	<1	8.8	63	530	2.2	3.0	<3	75	12.0	66
R18458	# Logan	3.80	0.50	3.30	<1	14.0	71	645	1.6	15.0	<4	66	12.0	61
R18459	# Logan	1.00	0.56	0.44	<1	12.0	47	536	1.0	5.3	<4	77	12.0	65
R19590	Logan	1.94	0.03	1.91	<1	14.0	44	520	1.2	12.0	<4	76	12.0	63
R19591	Logan	0.76	0.03	0.73	<1	14.0	54	500	1.4	13.0	<4	77	12.0	68
R18630	Macon	2.90	0.18	2.72	<1	9.5	59	600	<1	10.0	<2	69	9.0	60
R18631	Macon	1.32	0.71	0.61	<1	13.0	56	580	<1	5.1	<2	76	13.0	66
R18695	Marion	1.09	0.19	0.90	<1	6.0	38	620	<1	4.7	<2.5	61	5.9	45
R18696	Marion	0.63	0.13	0.50	<1	9.8	48	485	<1	2.3	<2.5	65	7.4	71
R19596	Mason	0.50	0.02	0.48	<1	1.6	20	245	<1	2.2	<4	16	2.8	19
R19597	Mason	0.20	0.01	0.19	<1	1.9	<10	220	1.1	<2	<3	17	2.6	13
R19564	McDonough	1.27	0.03	1.24	<1	7.7	25	715	1.6	4.9	<2	68	7.8	52
R19565	McDonough	0.48	0.03	0.45	<1	16.0	48	585	1.9	1.0	<2	81	20.0	80
R19479	McHenry	0.86	0.03	0.83	<1	4.4	55	455	1.5	2.7	<2	49	10.0	44
R19480	McHenry	1.32	0.97	0.35	<1	8.5	56	445	1.9	3.7	<3	61	12.0	62
R19521	McHenry	1.88	0.04	1.84	<1	4.9	39	500	1.7	7.8	<3	48	7.8	41
R19522	McHenry	3.95	3.70	0.25	<1	3.4	47	310	1.3	5.7	<3	40	6.4	34
R18452	McLean	2.46	0.13	2.33	<1	10.4	50	656	1.0	11.0	<4	72	12.0	56
R18453	McLean	0.68	0.10	0.58	<1	14.0	54	615	1.2	6.8	<4	90	13.0	71
R18454	McLean	1.59	0.10	1.49	<1	8.6	50	613	<1	6.5	<4	64	8.8	54
R18455	& McLean	1.06	0.48	0.58	<1	7.1	30	318	<1	7.6	<4	43	6.7	31
R18456	& McLean	2.07	0.08	1.99	<1	9.6	42	814	1.0	16.0	<4	78	12.0	56
R18457	McLean	0.70	0.05	0.65	<1	12.7	46	739	1.0	7.3	<4	81	15.0	59
R19592	Menard	1.03	0.02	1.01	<1	6.3	43	490	1.2	3.0	<4	63	9.1	56
R19593	Menard	0.28	0.02	0.26	<1	8.1	46	480	1.2	2.3	<4	70	11.0	58

*Continued on next page*



## Electronic Filing: Received, Clerk's Office 3/24/2022

Analysis no.	County	Tot. C (%)	Inc. C (%)	Org. C (%)	Ag	As	B	Ba	Be	Br	Cd	Ce	Co	Cr
R19594	Menard	1.70	0.14	1.56	<1	7.2	54	480	1.2	6.9	<4	63	7.6	53
R19595	Menard	1.59	0.20	1.39	<1	7.8	40	500	1.1	8.9	<4	65	8.4	53
R19554	Mercer	3.58	0.05	3.53	<1	8.7	38	600	1.2	13.0	<2	68	9.2	56
R19555	Mercer	0.87	0.03	0.84	<1	13.0	35	620	1.5	7.5	<2	70	11.0	68
R19700	Morgan	3.61	0.03	3.58	<1	9.3	28	650	1.1	15.0	<3	73	9.8	58
R19701	Morgan	1.03	0.03	1.00	<1	14.0	38	570	1.1	8.0	<3	75	14.0	74
R18794	Ogle	2.83	0.15	2.68	<1	6.4	47	620	1.3	8.7	<3	60	9.8	50
R18795	Ogle	0.45	0.09	0.36	<1	9.2	50	560	1.0	3.7	<3	53	8.4	48
R18796	Ogle	1.23	0.16	1.07	<1	3.9	45	655	1.1	3.4	<3	55	8.2	48
R18797	Ogle	0.36	0.07	0.29	<1	7.9	42	470	1.0	3.2	<3	56	8.3	51
R18640	Peoria	2.60	0.22	2.38	<1	8.9	42	480	1.2	4.7	<2.4	67	11.0	62
R18641	Peoria	2.07	1.47	0.60	<1	8.5	46	360	1.4	2.5	<2.6	61	12.0	66
R18642	Peoria	1.23	0.05	1.18	<1	9.9	45	710	1.0	6.2	<2.5	75	14.0	61
R18643	Peoria	0.56	0.12	0.44	<1	15.0	53	640	1.3	3.6	<2.6	81	13.0	71
R19538	Peoria	2.86	0.16	2.70	<1	17.0	63	490	1.4	2.9	<2	87	21.0	91
R19539	Peoria	4.54	3.85	0.69	<1	8.6	57	210	1.1	1.0	<2	63	12.0	67
R18691	Perry	1.07	0.22	0.85	<1	11.0	57	510	1.2	5.6	<2.5	69	14.0	63
R18692	Perry	0.40	0.13	0.27	<1	11.0	49	640	1.5	2.5	<2.7	89	8.6	66
R19690	Pike	1.07	0.53	0.54	<1	6.3	32	520	1.2	5.7	<3	63	7.8	57
R19691	Pike	1.80	1.66	0.14	<1	6.9	36	540	1.5	3.1	<3	59	8.1	51
R19692	Pike	1.05	0.12	0.93	<1	7.7	34	585	1.7	3.7	<3	70	12.0	59
R19693	Pike	0.38	0.03	0.35	<1	14.0	33	490	1.2	2.0	<3	72	9.4	70
R18568	Rock Island	3.02	0.16	2.86	<1	5.1	45	462	<1	9.4	<1.1	64	7.6	55
R18569	Rock Island	0.60	0.11	0.49	<1	7.4	46	545	<1	2.7	<0.7	81	15.0	65
R19552	Rock Island	0.93	0.04	0.89	<1	7.0	42	690	1.4	3.0	<2	71	13.0	56
R19553	Rock Island	0.26	0.05	0.21	<1	13.0	37	625	1.2	1.0	<3	78	12.0	70
R19556	Rock Island	3.54	0.06	3.48	<1	8.7	38	630	1.5	12.0	<2	65	9.8	53
R19557	Rock Island	0.63	0.04	0.59	<1	11.0	32	570	1.6	3.2	<2	73	12.0	73
R19696	Sangamon	2.02	0.02	2.00	<1	5.6	39	555	1.6	8.2	<3	65	9.4	51
R19697	Sangamon	0.47	0.02	0.45	<1	8.2	34	450	<1	5.3	<3	68	9.8	61
R19706	Schuyler	2.44	0.03	2.41	<1	8.8	38	640	<1	11.0	<3	73	11.0	58
R19707	Schuyler	0.59	0.02	0.57	<1	15.0	33	660	1.6	5.6	<3	75	13.0	70
R19694	Scott	1.86	0.03	1.83	<1	10.0	40	615	<1	7.4	<3	75	11.0	60
R19695	Scott	0.46	0.01	0.45	<1	14.0	45	515	1.3	5.8	<3	85	12.0	70
R18817	Stark	1.48	0.12	1.36	<1	7.2	30	805	<1	5.4	<3	71	13.0	56
R18818	Stark	0.32	0.09	0.23	<1	14.0	40	710	1.1	2.5	<3	83	13.0	70
R19527	Stephenson	3.06	1.46	1.60	<1	5.3	39	480	1.8	5.5	<2	52	7.4	42
R19528	Stephenson	2.34	0.66	1.68	<1	6.0	35	625	1.3	6.3	<3	66	7.9	53
R18636	Tazewell	4.72	0.24	4.48	<1	12.0	64	680	<1	11.0	<2.4	71	12.0	58
R18637	Tazewell	0.75	0.14	0.61	<1	15.0	53	620	<1	5.1	<2.5	73	11.0	75
R18823	Vermilion	3.70	0.19	3.51	<1	11.0	67	515	1.5	9.8	<3	72	14.0	63
R18824	Vermilion	1.65	1.45	0.20	<1	12.0	79	470	1.7	3.3	<3	74	16.0	73
R19373	Vermilion	3.55	0.06	3.49	<1	10.0	36	535	1.2	11.0	<3	66	13.0	56
R19374	Vermilion	0.74	0.05	0.69	<1	14.0	61	510	1.6	4.6	<3	80	18.0	78
R19375	Vermilion	3.04	0.03	3.01	<1	11.0	29	605	1.1	9.0	<3	70	10.7	53
R19376	^ Vermilion	0.72	0.02	0.70	<1	46.0	46	580	1.1	4.4	<3	78	14.0	63
R19558	Warren	1.29	0.03	1.26	<1	13.0	42	420	1.5	6.5	<2	71	14.0	64
R19559	Warren	0.49	0.03	0.46	<1	14.0	45	390	1.7	2.0	<2	69	14.0	61
R19560	Warren	0.90	0.03	0.87	<1	6.1	31	595	1.0	3.4	<2	67	11.0	58
R19561	Warren	0.38	0.02	0.36	<1	14.0	27	555	1.0	2.2	<3	84	15.0	71
R19379	Washington	1.01	0.05	0.96	<1	11.0	38	690	<1	4.7	<3	77	11.0	59
R19380	Washington	0.39	0.10	0.29	<1	12.0	43	935	1.2	2.0	<3	79	15.0	68
R19383	Washington	0.81	0.02	0.79	<1	7.5	39	500	1.0	4.1	<3	66	9.1	47
R19384	Washington	0.58	0.03	0.55	<1	9.7	34	435	<1	2.0	<3	58	13.0	47
R19385	Washington	1.42	0.02	1.40	<1	14.0	55	555	1.3	6.5	<3	64	9.3	51
R19386	Washington	0.52	0.03	0.49	<1	15.0	48	915	1.5	2.5	<3	64	9.8	71
R19540	Whiteside	3.14	1.00	2.14	<1	8.3	57	440	1.0	6.0	<2	56	8.7	61
R19541	Whiteside	2.93	0.76	2.17	<1	8.9	49	505	1.2	6.4	<2	61	9.2	61
R19542	Whiteside	1.02	0.07	0.95	<1	7.4	53	650	1.2	3.4	<3	67	10.4	60

*Continued on next page*

Electronic Filing: Received, Clerk's Office 3/24/2022

Analysis no.	County	Tot. C (%)	Inc. C (%)	Org. C (%)	Ag	As	B	Ba	Be	Br	Cd	Ce	Co	Cr
R19543	Whiteside	0.33	0.04	0.29	<1	11.0	56	595	1.3	2.0	<3	76	12.0	66
R19461	Will	2.09	0.05	2.04	<1	9.4	51	485	1.7	7.9	<3	65	12.0	63
R19462	Will	1.58	1.10	0.48	<1	11.0	55	535	2.0	2.0	<3	81	15.0	70
R19463	Will	1.40	0.02	1.38	<1	8.7	52	500	1.7	4.6	<3	66	14.0	55
R19464	Will	1.73	1.15	0.58	<1	14.0	73	480	2.1	3.0	<3	74	16.0	69
R18687	Williamson	0.87	0.04	0.83	<1	14.0	46	750	1.2	3.3	<2.5	75	13.0	58
R18688	Williamson	0.42	0.19	0.23	<1	12.0	42	605	1.3	5.1	<2.5	74	8.1	71
R19525	Winnebago	1.58	0.02	1.56	<1	6.4	49	490	1.8	8.3	<3	53	8.0	45
R19526	Winnebago	0.57	0.02	0.55	<1	8.9	50	595	2.2	7.4	<2	71	10.0	60
R18819	Woodford	1.74	1.14	0.60	<1	12.0	36	515	1.2	4.0	<3	70	11.0	59
R18820	Woodford	1.60	1.58	0.02	<1	12.0	32	540	1.1	4.3	<3	70	12.0	58
Quality control replicate samples														
R19536	Kane	3.13	0.03	3.10	<1	7.3	35	525	1.3	12.0	<2	64	9.6	55
R19519		3.48	0.03	3.45	<1	7.5	43	630	1.4	13.0	<2	66	9.6	56
R19537	Kane	1.20	0.53	0.67	<1	9.8	62	460	1.1	7.6	<2	67	12.0	60
R19520		1.26	0.49	0.77	<1	10.0	51	595	2.2	7.3	<2	68	12.0	63
R19550	Henry	0.86	0.06	0.80	<1	8.4	51	605	<1	3.8	<2	75	13.0	65
R19546		0.83	0.03	0.80	<1	8.5	32	565	1.0	3.9	<2	73	12.0	64
R19551	Henry	0.32	0.03	0.29	<1	11.0	48	480	1.1	<2	<2	76	11.0	64
R19547		0.30	0.02	0.28	<1	11.0	31	505	1.1	1.8	<3	75	11.0	66
R19686	Logan	1.92	0.04	1.88	<1	13.0	45	530	1.3	14.0	<3	74	12.0	64
R19590		1.94	0.03	1.91	<1	14.0	44	520	1.2	12.0	<4	76	12.0	63
R19687	Logan	0.78	0.04	0.74	<1	14.0	38	540	1.6	12.0	<3	76	12.0	67
R19591		0.76	0.03	0.73	<1	14.0	54	500	1.4	13.0	<4	77	12.0	68

Continued on next page

Electronic Filing: Received, Clerk's Office 3/24/2022

Analysis no.	County	Cs	Cu	Dy	Eu	Ga	Hf	La	Li	Lu	Ni	Pb	Rb	Sb	Sc	Se
R19598	Adams	3.4	26	5.3	1.1	11.0	11.0	35	29	0.48	<20	<10	73	0.8	8.6	<1
R19599	Adams	5.1	40	5.9	1.4	17.0	8.9	41	40	0.54	25	<10	91	1.0	12.0	<0.8
R19600	Adams	1.9	27	3.8	0.8	6.7	11.0	26	17	0.38	<18	10	49	0.7	5.2	<0.6
R19601	Adams	2.1	30	2.8	0.7	7.2	8.2	22	17	0.33	<18	10	37	0.5	4.9	<0.6
R19688	Adams	4.4	32	4.4	1.1	15.0	10.0	36	22	0.43	18	14	86	1.2	10.0	<1
R19689	Adams	4.1	36	5.4	1.4	15.0	11.0	40	23	0.53	19	14	89	1.2	11.0	<0.8
R19523	Boone	2.5	27	4.2	1.0	9.1	13.0	32	16	0.41	<10	31	79	0.7	6.7	<0.8
R19524	Boone	4.2	34	5.8	1.3	14.0	11.0	39	23	0.55	14	41	81	1.1	11.0	<0.8
R19704	Brown	2.9	19	4.9	1.1	9.0	12.0	36	14	0.50	<10	20	80	0.9	7.4	<1
R19705	Brown	4.2	38	5.2	1.3	13.0	9.8	37	22	0.53	23	21	82	1.3	11.0	<0.8
R18790	Bureau	3.5	16	4.8	1.2	14.0	11.0	36	14	0.43	<15	13	87	0.9	9.0	<0.8
R18791	Bureau	3.7	20	5.1	1.4	14.0	11.0	39	19	0.55	<15	12	72	1.1	10.0	<0.8
R18815	Bureau	3.1	15	4.8	1.1	14.0	11.0	33	15	0.43	<15	12	84	0.9	8.4	<0.8
R18816	Bureau	3.5	36	7.0	1.9	15.0	11.0	41	16	0.65	<15	11	69	1.7	10.2	<0.8
R19533	Carroll	2.3	15	4.6	1.1	12.0	14.0	33	14	0.50	<10	22	70	0.7	8.0	<0.8
R19534	Carroll	2.5	22	4.7	1.3	13.0	13.0	35	15	0.49	<10	20	61	0.8	9.5	<0.8
R19702	Cass	1.6	20	4.0	1.0	9.3	13.0	23	11	0.36	<10	15	57	0.6	6.4	<0.8
R19703	Cass	1.9	19	3.5	0.9	9.4	9.7	22	8	0.38	<10	39	61	0.6	6.6	<0.8
R18524	Champaign	4.1	25	4.6	1.2	12.0	7.8	36	22	0.49	<11	30	95	0.8	9.8	<1
R18525	Champaign	4.6	24	5.1	1.3	17.0	8.4	37	30	0.54	26	27	88	0.9	11.0	<1
R18821	Champaign	2.6	18	3.0	0.7	9.0	6.6	23	10	0.35	<15	20	67	0.8	6.2	<0.8
R18822	Champaign	4.3	20	3.5	0.9	12.0	5.2	25	24	0.34	<13	22	89	0.7	9.2	<0.8
R18446	* Champaign (30 ft)	2.6	15	4.7	1.1	12.0	12.0	35	15	0.48	<13	15	73	0.8	7.0	<1
R18447	* Champaign (30 ft)	4.3	24	5.0	1.2	17.0	9.6	36	25	0.50	<12	<10	80	1.1	12.0	<1
R18448	* Champaign (100 ft)	2.7	15	4.6	1.1	9.5	12.0	35	20	0.49	<14	11	72	0.9	7.4	1.0
R18449	* Champaign (100 ft)	3.8	20	4.5	1.3	12.0	7.9	32	23	0.44	18	<10	81	0.9	10.0	<0.8
R18450	Champaign (160 ft)	2.8	10	5.2	1.0	10.0	12.0	36	19	0.46	17	<10	74	1.0	7.4	<1
R18451	Champaign (160 ft)	4.0	24	5.4	1.4	14.0	10.4	36	24	0.51	<13	20	75	1.0	11.0	<0.8
R18632	Christian	2.7	21	5.1	1.1	9.6	11.0	33	11	0.49	<16	16	64	1.0	7.4	1.0
R18633	Christian	4.4	29	6.0	1.5	16.0	9.3	41	24	0.55	21	20	75	1.0	12.0	<1
R19377	Christian	2.5	14	4.8	1.0	9.7	12.0	32	11	0.52	<13	16	73	0.8	6.8	<0.8
R19378	Christian	3.2	14	3.7	0.9	10.0	7.2	29	16	0.39	<13	10	77	1.0	7.2	1.0
R19698	Christian	2.9	23	5.9	1.3	10.0	12.0	39	16	0.52	<10	72	75	1.0	7.1	<0.8
R19699	Christian	4.7	39	5.1	1.3	16.0	9.8	39	26	0.55	10	55	85	1.3	12.0	<0.8
R19387	Clay	3.0	15	4.2	1.0	11.0	12.0	33	16	0.48	<13	36	68	1.2	7.2	<1
R19388	Clay	5.2	33	5.2	1.3	16.0	10.0	39	25	0.53	16	38	86	1.2	14.0	<0.8
R19381	Clinton	2.4	8	5.0	1.1	8.2	13.0	33	10	0.47	<13	25	67	0.9	6.4	<1
R19382	Clinton	4.9	23	5.3	1.4	16.0	8.7	40	28	0.53	18	26	95	1.2	12.0	<0.8
R18634	Coles	3.1	19	4.0	1.0	12.0	8.1	27	18	0.46	16	20	74	0.8	7.9	1.0
R18635	Coles	4.3	26	4.2	1.1	13.0	5.7	29	26	0.43	17	22	82	0.7	10.0	<0.8
R18792	DeKalb	3.2	20	4.3	1.0	11.0	10.0	34	15	0.43	<15	17	84	0.8	8.0	<0.8
R18793	DeKalb	4.0	21	4.8	1.2	13.0	9.3	35	19	0.48	<15	10	89	1.1	10.0	<0.8
R19467	DuPage	4.6	53	4.6	1.1	12.0	5.1	29	38	0.42	28	51	97	1.0	10.0	1.5
R19468	DuPage	5.3	50	4.5	1.1	16.0	6.4	32	53	0.41	23	41	97	0.5	11.0	1.5
R19469	DuPage	4.2	32	4.3	1.0	13.0	8.0	32	30	0.44	31	36	110	0.9	9.8	<0.8
R19470	DuPage	7.3	55	5.6	1.5	19.0	5.5	42	53	0.49	63	39	150	1.1	15.0	<0.5
R18693	Franklin	3.2	24	4.4	1.1	9.6	13.0	36	10	0.55	<16	18	75	1.1	7.9	<0.8
R18694	Franklin	3.9	26	4.6	1.3	15.0	11.0	40	12	0.48	21	<10	74	1.1	12.0	<0.8
R18638	Fulton	3.5	21	5.0	1.1	13.0	11.0	35	10	0.52	16	25	78	1.1	8.8	<0.8
R18639	Fulton	3.9	32	7.8	1.8	13.0	10.0	44	15	0.60	25	12	74	1.3	12.0	<0.8
R18644	Fulton	4.0	27	4.9	1.3	14.0	11.0	37	15	0.50	<16	19	77	1.2	11.0	<0.8
R18645	Fulton	2.4	27	4.9	1.2	10.0	11.0	32	8	0.47	<17	13	54	0.8	8.7	<0.8
R19580	Grundy	3.0	39	4.2	1.1	11.0	7.2	29	23	0.39	<18	15	91	0.6	7.5	<1
R19581	Grundy	2.5	34	5.2	1.3	10.0	7.6	27	15	0.39	<18	28	89	0.4	7.4	<0.8
R19566	Hancock	2.8	36	4.8	1.1	10.0	12.0	36	18	0.52	<11	37	75	1.0	7.6	<1
R19567	Hancock	5.3	51	6.7	1.5	17.0	8.6	43	31	0.54	56	25	84	1.2	12.0	<0.8
R19568	Hancock	2.0	24	4.7	1.0	8.5	14.0	33	12	0.46	<11	14	72	0.7	6.0	<0.8
R19569	Hancock	3.6	34	4.9	1.3	14.0	11.0	34	18	0.46	<11	12	80	1.0	9.7	<0.8
R19562	Henderson	2.3	27	3.7	1.0	9.8	8.5	26	13	0.33	<11	24	71	0.5	6.3	<0.8

Continued on next page

Electronic Filing: Received, Clerk's Office 3/24/2022

Analysis no.	County	Cs	Cu	Dy	Eu	Ga	Hf	La	Li	Lu	Ni	Pb	Rb	Sb	Sc	Se
R19563	Henderson	2.4	30	4.3	1.0	11.0	9.0	29	14	0.41	<11	24	62	0.4	7.2	<0.8
R19544	Henry	2.8	35	4.1	1.0	10.0	11.0	32	15	0.44	<10	10	77	0.7	7.1	<1
R19545	Henry	3.7	37	4.3	1.1	12.0	10.0	34	22	0.49	<10	13	71	1.0	9.4	<0.8
R19546	Henry	3.3	35	4.7	1.1	13.0	13.0	37	17	0.52	20	19	85	1.0	8.4	<0.8
R19547	Henry	3.5	36	5.2	1.3	13.0	13.0	36	22	0.53	<10	26	74	0.9	11.0	<0.8
R19548	Henry	3.7	69	5.7	1.5	12.0	12.0	40	21	0.56	18	25	76	1.3	10.4	<0.8
R19549	Henry	3.0	35	5.6	1.3	12.0	12.0	37	19	0.55	18	26	64	0.9	9.4	<0.8
R18689	Jackson	2.9	21	4.8	1.1	12.0	13.0	34	14	0.51	<16	50	79	1.1	7.1	<0.8
R18690	Jackson	4.6	25	4.3	1.0	13.0	10.0	34	14	0.47	<17	14	81	1.3	11.0	<1
R19529	Jo Daviess	2.5	29	4.4	0.9	11.0	13.0	32	18	0.44	<9	16	72	0.8	6.4	<0.8
R19530	Jo Daviess	3.6	73	5.3	1.3	14.0	11.0	38	27	0.49	<10	23	80	0.9	11.0	<0.8
R19531	Jo Daviess	3.5	44	4.3	1.0	12.0	11.0	31	21	0.44	<10	46	87	0.9	8.7	<0.8
R19532	Jo Daviess	5.1	52	4.8	1.3	19.0	8.3	39	30	0.46	<10	32	88	1.0	13.0	<0.8
R19519	Kane	3.5	29	4.6	1.1	12.0	9.1	34	20	0.45	<9	36	87	0.9	8.6	<0.8
R19520	Kane	4.0	45	5.4	1.3	15.0	7.4	35	26	0.50	<9	20	81	1.0	10.0	<1
R19582	Kane	4.1	40	4.8	1.2	12.0	7.9	35	27	0.46	<18	16	99	1.1	9.5	<0.8
R19583	Kane	2.0	40	2.4	0.7	7.6	3.6	19	13	0.28	19	22	50	1.9	5.8	<0.8
R19473	Kankakee	2.0	34	2.3	0.6	7.5	6.0	20	12	0.26	<18	23	62	0.8	4.6	<0.8
R19474	Kankakee	1.9	35	1.7	0.5	7.6	4.0	14	10	0.23	22	18	54	0.6	4.5	<0.8
R19465	Kendall	4.4	44	5.0	1.2	13.0	8.8	35	28	0.44	19	36	99	1.0	10.4	<1
R19466	Kendall	4.7	51	5.4	1.4	15.0	9.5	39	34	0.54	28	38	85	1.1	11.0	<0.8
R19586	Knox	3.3	40	4.3	1.0	12.0	9.8	36	18	0.44	<18	25	87	0.8	8.0	<0.8
R19587	Knox	4.0	30	5.1	1.1	14.0	10.0	37	24	0.48	<18	21	91	0.9	9.4	<0.8
R19588	Knox	3.4	31	5.0	1.2	12.0	10.0	36	22	0.49	<18	17	94	0.9	8.7	<1
R19589	Knox	4.7	30	5.2	1.3	17.0	9.5	38	25	0.53	<20	15	92	1.1	11.0	<1
R19584	LaSalle	2.7	21	3.5	0.9	9.0	7.5	26	22	0.31	<18	19	69	1.2	6.7	<0.8
R19585	LaSalle	2.5	19	4.1	1.0	9.4	9.3	32	25	0.38	<18	17	72	1.4	7.6	<0.8
R19471	Lake	3.4	44	3.9	1.1	11.0	6.2	28	24	0.37	44	48	77	0.7	9.7	<0.8
R19472	Lake	3.8	69	5.0	1.3	12.0	4.4	29	27	0.37	34	34	81	0.9	12.0	<0.8
R19475	Lake	4.3	60	4.4	1.0	13.0	6.6	32	33	0.42	<9	33	106	0.8	11.0	<0.8
R19476	Lake	4.3	54	3.4	0.9	12.0	4.2	27	30	0.34	21	21	84	0.7	10.0	<0.8
R19477	Lake	7.0	61	7.0	1.7	20.0	5.0	46	56	0.55	40	36	140	0.9	16.0	<0.8
R19478	Lake	4.3	49	3.4	0.9	12.0	3.7	25	33	0.33	34	20	90	0.6	9.9	<0.8
R18788	Livingston	4.8	23	4.8	1.2	13.0	6.6	35	28	0.42	18	34	110	0.9	11.0	<0.8
R18789	Livingston	5.1	23	5.0	1.4	13.0	7.2	37	28	0.44	14	26	105	0.9	12.0	<0.8
R18458	# Logan	3.5	30	4.7	1.1	13.0	8.4	32	21	0.44	26	238	74	1.5	9.1	<1
R18459	# Logan	3.6	23	5.7	1.5	16.0	11.0	43	21	0.57	29	25	71	1.1	11.0	1.0
R19590	Logan	3.5	45	5.1	1.3	12.0	11.0	37	25	0.54	<19	17	83	1.2	9.1	<1
R19591	Logan	4.0	35	5.9	1.4	13.0	11.0	37	26	0.54	19	17	82	1.1	11.0	<0.8
R18630	Macon	3.3	25	4.4	1.1	11.0	9.3	33	15	0.50	16	27	81	1.0	8.3	<0.8
R18631	Macon	4.5	31	5.5	1.4	13.0	8.5	38	22	0.52	<16	14	79	1.1	11.0	<1
R18695	Marion	2.3	12	3.8	0.9	9.3	12.0	30	8	0.46	<16	11	62	1.0	6.3	<0.8
R18696	Marion	5.1	26	4.2	1.1	16.0	9.2	34	27	0.46	<16	20	80	1.0	13.0	1.0
R19596	Mason	0.7	25	1.1	0.3	5.5	2.6	9	3	0.15	<20	<10	34	0.2	1.9	<0.5
R19597	Mason	0.8	26	1.3	0.3	4.3	3.0	10	3	0.16	<16	<10	36	0.2	1.9	<0.5
R19564	McDonough	2.6	32	4.1	1.0	8.1	12.0	34	12	0.45	<11	18	86	0.8	6.4	<0.8
R19565	McDonough	5.3	51	4.9	1.2	17.0	8.7	37	28	0.47	<11	21	89	1.5	12.0	<1
R19479	McHenry	2.2	32	2.9	0.6	8.9	7.6	24	17	0.33	<10	33	70	0.6	5.6	<0.8
R19480	McHenry	4.6	54	3.5	1.0	14.0	5.2	31	32	0.41	14	24	95	0.6	11.0	<0.8
R19521	McHenry	2.6	36	3.4	0.8	11.0	6.8	23	17	0.36	<10	29	77	0.5	7.0	<0.8
R19522	McHenry	2.1	31	2.8	0.7	9.2	4.7	20	18	0.30	<10	19	61	0.5	6.1	<0.8
R18452	McLean	3.4	20	4.4	1.1	12.0	9.7	34	20	0.43	<14	30	87	1.0	8.5	<0.8
R18453	McLean	4.6	29	5.9	1.5	17.0	9.8	40	27	0.53	18	23	86	1.2	12.0	<0.8
R18454	McLean	2.8	20	4.5	1.0	10.0	10.0	31	17	0.43	<13	16	74	0.8	7.7	<1
R18455	& McLean	1.8	9	3.3	0.8	8.1	6.0	22	17	0.30	79	14	51	0.7	5.6	<1
R18456	& McLean	3.6	25	4.8	1.2	13.0	8.4	39	21	0.47	<14	21	90	0.9	9.2	<1
R18457	McLean	3.7	15	4.9	1.1	14.0	9.6	35	24	0.45	<17	33	88	0.9	9.3	<1
R19592	Menard	2.2	23	4.8	1.0	9.9	14.0	30	17	0.44	<18	17	74	0.7	6.7	<0.8
R19593	Menard	3.1	26	5.3	1.3	13.0	12.0	33	25	0.47	<20	13	78	0.8	9.8	<0.8

Continued on next page

Electronic Filing: Received, Clerk's Office 3/24/2022

Analysis no.	County	Cs	Cu	Dy	Eu	Ga	Hf	La	Li	Lu	Ni	Pb	Rb	Sb	Sc	Se
R19594	Menard	2.6	18	4.3	1.1	8.7	13.0	30	18	0.44	<19	12	73	0.9	7.1	<0.8
R19595	Menard	2.6	26	4.8	1.1	9.5	12.0	32	17	0.46	<19	10	71	0.8	7.7	<0.8
R19554	Mercer	3.2	30	4.9	1.1	11.0	10.0	34	18	0.49	13	29	92	1.1	8.0	1.2
R19555	Mercer	4.5	40	4.9	1.2	14.0	9.8	35	23	0.46	13	106	88	2.0	11.0	<0.8
R19700	Morgan	3.2	33	5.0	1.1	11.0	10.0	36	16	0.52	15	18	82	1.1	7.7	<1
R19701	Morgan	4.9	34	5.0	1.2	13.0	9.2	35	27	0.52	21	17	92	1.4	11.0	<1.2
R18794	Ogle	2.8	14	4.1	1.0	11.0	9.7	32	13	0.41	15	10	79	0.7	6.9	<0.8
R18795	Ogle	3.1	18	3.3	0.8	12.0	7.8	26	15	0.31	<15	<10	70	0.8	7.8	<0.8
R18796	Ogle	2.2	16	4.4	0.8	7.7	11.0	28	10	0.43	<15	10	68	0.6	5.8	<0.8
R18797	Ogle	2.8	16	3.2	0.7	9.3	7.7	24	12	0.36	<15	<10	58	0.6	7.7	<0.8
R18640	Peoria	3.5	23	4.8	1.1	11.0	8.5	32	13	0.45	20	10	78	1.1	9.2	1.0
R18641	Peoria	4.6	22	4.3	1.0	13.0	6.9	29	12	0.44	29	10	86	0.9	9.8	<0.8
R18642	Peoria	3.5	28	4.6	1.1	12.0	12.0	36	15	0.48	<16	12	84	1.1	8.9	<0.8
R18643	Peoria	4.5	34	5.4	1.4	15.0	11.0	38	18	0.50	17	12	83	1.3	12.0	1.0
R19538	Peoria	7.6	51	6.8	1.6	21.0	5.3	43	74	0.53	53	17	130	1.3	19.0	1.3
R19539	Peoria	5.8	40	4.3	1.2	14.0	3.8	31	17	0.42	34	11	103	0.9	12.0	<0.8
R18691	Perry	2.9	19	4.1	0.9	9.9	14.0	30	10	0.46	<16	30	67	1.1	7.2	<0.8
R18692	Perry	3.9	23	6.7	1.7	15.0	11.0	48	8	0.61	<18	21	79	1.0	10.0	<0.8
R19690	Pike	2.0	15	4.6	1.2	14.0	13.0	31	14	0.44	<10	12	56	0.7	7.5	<0.8
R19691	Pike	2.2	21	4.1	1.1	9.6	10.0	30	14	0.41	13	22	56	0.7	7.2	<0.8
R19692	Pike	2.6	21	5.1	1.2	10.0	13.0	35	15	0.52	<10	18	68	0.8	7.3	<0.8
R19693	Pike	3.9	36	4.7	1.2	14.0	11.0	36	23	0.47	16	35	75	1.1	11.0	<0.8
R18568	Rock Island	3.6	63	4.6	1.1	12.0	9.8	32	21	0.47	<15	41	77	0.6	8.6	<1
R18569	Rock Island	4.2	19	5.0	1.3	12.0	11.0	38	23	0.51	13	22	73	0.6	10.0	<1
R19552	Rock Island	3.1	22	4.6	1.1	9.2	12.0	36	17	0.49	<10	20	88	0.9	7.2	<0.8
R19553	Rock Island	4.7	38	5.3	1.3	16.0	10.0	40	25	0.49	<11	28	80	1.4	11.0	<0.8
R19556	Rock Island	3.2	27	4.7	1.0	12.0	10.0	32	15	0.44	<10	250	94	1.2	7.6	<1
R19557	Rock Island	4.8	34	4.4	1.2	15.0	9.5	37	25	0.49	<11	31	83	1.3	11.0	<1
R19696	Sangamon	2.4	23	5.0	1.2	8.4	12.0	33	17	0.48	<10	16	71	0.7	7.0	<0.8
R19697	Sangamon	3.5	27	5.0	1.2	12.0	9.7	33	23	0.45	19	43	85	0.8	9.5	<0.8
R19706	Schuyler	3.4	31	4.9	1.1	12.0	10.0	36	19	0.47	<9	22	82	1.0	8.0	<1
R19707	Schuyler	4.8	34	5.2	1.2	14.0	9.3	38	29	0.47	22	28	77	1.3	11.0	<1
R19694	Scott	2.9	33	5.3	1.3	12.0	13.0	37	18	0.50	<10	28	68	1.1	8.1	<0.8
R19695	Scott	4.0	35	6.4	1.4	14.0	11.0	39	25	0.55	16	28	82	1.1	11.0	<0.8
R18817	Stark	3.0	15	5.0	1.1	11.0	11.0	37	15	0.45	<15	11	88	0.8	7.6	<0.8
R18818	Stark	4.6	28	5.3	1.5	16.0	9.2	45	22	0.54	<15	14	82	1.2	11.0	<0.8
R19527	Stephenson	2.2	30	3.6	0.9	7.9	7.8	26	11	0.35	<10	21	62	0.6	5.8	<0.8
R19528	Stephenson	3.0	31	4.6	1.0	11.0	10.0	33	18	0.47	<10	13	80	0.7	7.6	<0.8
R18636	Tazewell	3.6	32	4.2	1.1	11.0	9.1	33	17	0.41	<16	40	89	1.3	8.7	<1
R18637	Tazewell	5.5	26	4.1	1.1	16.0	8.5	35	19	0.48	<16	21	85	1.5	12.0	<1
R18823	Vermilion	4.7	21	4.4	1.1	13.0	7.9	36	28	0.44	<13	52	101	1.2	10.4	<1
R18824	Vermilion	7.0	24	4.9	1.3	17.0	5.4	38	43	0.47	26	31	121	0.9	14.0	<0.8
R19373	Vermilion	4.3	19	4.6	1.0	13.0	7.3	32	23	0.40	<13	29	103	2.0	9.5	<1
R19374	Vermilion	7.8	32	5.1	1.3	18.0	5.5	40	47	0.45	33	14	140	1.0	15.0	<0.8
R19375	Vermilion	3.2	53	5.2	1.2	12.0	10.5	35	20	0.46	13	25	79	1.1	8.3	<1
R19376	^ Vermilion	3.9	22	5.7	1.5	14.0	10.0	40	24	0.52	20	14	73	1.0	11.0	<0.8
R19558	Warren	3.8	30	4.6	1.2	14.0	7.5	34	36	0.47	13	24	74	1.1	11.0	<0.8
R19559	Warren	4.2	48	5.0	1.2	15.0	7.4	34	37	0.48	18	23	78	0.9	11.0	<0.8
R19560	Warren	2.4	19	4.5	1.0	11.0	14.0	34	13	0.49	<14	16	70	0.9	6.8	<1
R19561	Warren	4.1	37	5.9	1.4	15.0	10.5	41	21	0.57	<11	19	79	1.2	11.0	<1
R19379	Washington	2.7	15	4.9	1.2	11.0	14.0	35	10	0.51	<13	16	67	1.2	7.2	2.6
R19380	Washington	4.7	25	5.7	1.4	14.0	9.2	39	20	0.51	17	18	85	1.1	11.0	<0.8
R19383	Washington	2.5	9	4.8	1.1	10.0	11.0	32	10	0.43	<13	18	65	0.9	6.4	<1
R19384	Washington	2.5	12	4.1	1.0	11.0	10.0	28	11	0.42	<13	24	61	0.9	6.8	<1
R19385	Washington	2.0	10	3.9	0.8	7.2	14.0	30	8	0.46	<13	45	61	1.1	5.7	<0.8
R19386	Washington	4.9	24	4.2	1.0	15.0	9.2	31	26	0.42	<13	28	80	1.4	12.0	2.2
R19540	Whiteside	2.9	44	3.9	1.0	12.0	8.2	30	17	0.44	<10	19	69	1.0	8.1	<0.8
R19541	Whiteside	3.1	39	4.1	1.0	11.0	8.1	31	20	0.43	25	26	75	0.9	8.3	<1
R19542	Whiteside	2.6	24	5.0	1.1	10.0	13.0	35	15	0.48	21	13	77	0.8	7.8	<0.8

Continued on next page

Electronic Filing: Received, Clerk's Office 3/24/2022

Analysis no.	County	Cs	Cu	Dy	Eu	Ga	Hf	La	Li	Lu	Ni	Pb	Rb	Sb	Sc	Se
R19543	Whiteside	3.7	33	5.0	1.2	15.0	11.0	37	19	0.50	<10	20	71	1.0	10.0	<0.8
R19461	Will	4.4	31	4.3	1.0	12.0	7.6	31	32	0.42	28	40	110	0.9	9.7	<1
R19462	Will	6.4	45	5.2	1.3	16.0	5.5	37	49	0.44	45	26	120	0.8	13.0	<0.8
R19463	Will	3.6	42	4.2	0.9	12.0	8.6	32	26	0.43	<18	44	97	0.9	8.2	<0.8
R19464	Will	6.6	53	4.8	1.3	17.0	5.2	38	46	0.48	45	28	130	1.0	13.0	<0.8
R18687	Williamson	2.6	17	4.0	1.1	11.0	13.0	33	8	0.50	<17	17	69	1.3	6.7	1.0
R18688	Williamson	4.8	21	4.8	1.2	16.0	9.9	37	14	0.49	17	16	86	1.2	11.0	<0.8
R19525	Winnebago	2.4	27	3.4	0.9	8.5	9.4	27	14	0.36	<10	28	62	0.7	6.4	<0.8
R19526	Winnebago	3.5	40	4.8	1.1	12.0	9.7	34	22	0.48	<10	28	68	0.8	9.9	<0.8
R18819	Woodford	3.6	21	4.9	1.3	13.0	9.4	35	21	0.45	<15	11	71	0.9	10.1	<0.8
R18820	Woodford	3.7	22	5.2	1.4	13.0	9.0	37	21	0.54	<15	11	76	0.9	10.2	<0.8
Quality control replicate samples																
R19536	Kane	3.4	29	4.5	1.1	12.0	9.1	33	19	0.48	<10	26	82	0.7	8.6	<0.8
R19519		3.5	29	4.6	1.1	12.0	9.1	34	20	0.45	<9	36	87	0.9	8.6	<0.8
R19537	Kane	3.8	41	5.2	1.3	14.0	7.3	34	27	0.47	16	11	75	1.0	10.0	<0.8
R19520		4.0	45	5.4	1.3	15.0	7.4	35	26	0.50	<9	20	81	1.0	10.0	<1
R19550	Henry	3.3	36	5.2	1.2	11.0	13.0	36	17	0.55	<11	23	84	0.9	8.4	<0.8
R19546		3.3	35	4.7	1.1	13.0	13.0	37	17	0.52	20	19	85	1.0	8.4	<0.8
R19551	Henry	3.4	36	5.0	1.3	13.0	12.0	36	21	0.54	<11	20	72	0.9	11.0	<0.8
R19547		3.5	36	5.2	1.3	13.0	13.0	36	22	0.53	<10	26	74	0.9	11.0	<0.8
R19686	Logan	3.7	38	5.5	1.3	12.0	12.0	36	17	0.49	<9	18	83	1.1	9.1	<0.8
R19590		3.5	45	5.1	1.3	12.0	11.0	37	25	0.54	<19	17	83	1.2	9.1	<1
R19687	Logan	4.0	26	6.2	1.4	14.0	11.0	37	20	0.49	15	24	77	1.2	11.0	<0.8
R19591		4.0	35	5.9	1.4	13.0	11.0	37	26	0.54	19	17	82	1.1	11.0	<0.8

Continued on next page



Electronic Filing: Received, Clerk's Office 3/24/2022

Analysis no.	County	Sm	Sr	Ta	Tb	Th	Tl	U	V	Yb	Zn
R19598	Adams	5.6	100	1.00	0.78	10.0	1	2.7	65	3.0	48.0
R19599	Adams	6.9	100	1.00	0.92	11.0	1	3.3	104	3.1	68.0
R19600	Adams	4.1	80	0.70	0.60	7.2	<1	3.2	44	2.3	33.0
R19601	Adams	3.5	60	0.63	0.52	6.4	1	2.4	52	1.9	26.0
R19688	Adams	5.5	110	1.00	0.72	12.0	2	2.5	84	2.8	74.1
R19689	Adams	6.4	125	1.10	0.89	11.0	<1	3.9	60	3.3	72.9
R19523	Boone	4.3	120	0.97	0.69	9.0	<1	3.0	82	2.5	47.0
R19524	Boone	6.6	120	0.91	0.93	11.0	<1	3.0	102	3.1	75.0
R19704	Brown	5.6	110	1.00	0.83	9.7	1	3.0	60	3.0	49.5
R19705	Brown	6.3	100	0.98	0.84	11.0	<1	3.5	130	3.0	93.1
R18790	Bureau	5.5	115	0.97	0.82	9.7	2	3.5	76	2.9	118.0
R18791	Bureau	6.8	125	0.92	0.99	10.0	3	3.3	105	3.3	79.0
R18815	Bureau	5.1	115	1.00	0.76	9.1	2	4.0	61	2.7	64.0
R18816	Bureau	8.8	135	0.92	1.30	10.0	1	3.5	136	4.0	54.0
R19533	Carroll	5.5	135	0.87	0.80	8.8	1	4.8	92	2.8	46.0
R19534	Carroll	6.0	155	0.88	0.84	9.1	1	3.8	128	3.1	53.0
R19702	Cass	4.2	130	0.61	0.62	5.9	1	<2.5	43	2.2	36.0
R19703	Cass	4.0	115	0.56	0.55	5.8	<1	2.0	52	2.0	33.8
R18524	Champaign	5.9	100	0.92	0.86	9.3	2	3.4	83	2.8	80.0
R18525	Champaign	6.4	106	0.91	0.91	10.0	2	3.0	110	3.1	62.0
R18821	Champaign	3.6	85	0.57	0.48	6.3	1	2.0	58	1.8	61.0
R18822	Champaign	4.3	80	0.69	0.59	7.3	3	2.0	69	2.0	50.0
R18446	* Champaign (30 ft)	5.4	98	1.00	0.78	8.8	2	3.6	77	3.0	47.0
R18447	* Champaign (30 ft)	6.0	97	0.95	0.76	10.0	2	4.2	96	3.1	80.0
R18448	* Champaign (100 ft)	5.7	98	1.00	0.74	9.3	2	3.6	59	2.9	51.0
R18449	* Champaign (100 ft)	6.0	106	0.80	0.84	8.6	1	4.0	70	2.8	70.0
R18450	Champaign (160 ft)	5.4	98	1.10	0.74	9.6	2	4.5	70	2.9	51.0
R18451	Champaign (160 ft)	6.5	106	0.96	0.91	10.0	1	3.4	97	3.1	80.0
R18632	Christian	5.3	110	1.00	0.89	9.0	2	4.2	75	2.8	47.7
R18633	Christian	7.1	110	0.96	1.00	11.0	1	3.5	116	3.4	78.6
R19377	Christian	5.1	100	1.00	0.74	8.9	1	3.3	61	2.9	43.0
R19378	Christian	4.3	100	0.77	0.63	7.9	1	3.3	61	2.2	42.0
R19698	Christian	6.2	105	1.00	0.97	9.5	2	3.4	105	3.4	47.6
R19699	Christian	6.2	100	0.97	0.92	12.0	<1	3.8	139	3.1	96.3
R19387	Clay	5.0	80	1.10	0.72	10.0	1	3.6	119	2.9	35.0
R19388	Clay	6.4	95	1.10	0.92	12.0	1	3.7	168	3.1	73.0
R19381	Clinton	5.2	105	1.00	0.74	8.9	1	2.8	85	2.8	19.0
R19382	Clinton	6.4	115	1.00	0.90	11.0	1	3.9	137	3.1	78.0
R18634	Coles	4.6	90	0.75	0.68	7.6	1	3.3	64	2.4	64.5
R18635	Coles	5.4	90	0.72	0.72	7.9	2	3.4	75	2.4	60.9
R18792	DeKalb	5.2	105	0.93	0.65	9.6	2	3.4	74	2.7	72.0
R18793	DeKalb	5.7	95	0.88	0.86	9.7	1	2.8	98	2.8	74.0
R19467	DuPage	5.0	100	0.71	0.82	8.3	1	4.9	78	2.5	121.0
R19468	DuPage	5.3	115	0.85	0.69	9.6	1	6.7	82	2.6	98.0
R19469	DuPage	4.6	90	1.00	0.69	9.4	1	4.2	100	2.5	83.0
R19470	DuPage	7.0	90	0.96	0.87	11.0	1	4.6	163	2.9	104.0
R18693	Franklin	5.4	80	1.10	0.80	11.0	1	3.3	64	3.1	50.2
R18694	Franklin	6.6	110	1.00	0.84	11.0	1	3.5	83	3.0	64.3
R18638	Fulton	5.4	100	1.00	0.83	9.9	2	4.0	87	2.9	106.0
R18639	Fulton	8.5	110	0.94	1.20	10.0	2	3.8	120	3.9	94.7
R18644	Fulton	5.9	100	1.00	0.83	11.0	1	3.8	83	3.1	84.1
R18645	Fulton	5.8	140	0.86	0.78	8.2	1	2.0	52	2.8	48.6
R19580	Grundy	5.2	80	0.78	0.73	7.6	1	2.7	68	2.3	71.0
R19581	Grundy	6.0	65	0.68	0.82	7.6	1	2.5	71	2.4	78.0
R19566	Hancock	5.5	120	1.00	0.75	10.0	2	4.1	88	3.0	59.0
R19567	Hancock	7.4	125	1.00	0.95	12.0	<1	3.5	134	3.3	97.0
R19568	Hancock	5.2	125	0.95	0.75	8.5	<1	3.1	71	2.9	44.0
R19569	Hancock	6.0	125	0.89	0.77	9.9	1	3.5	132	2.8	70.0
R19562	Henderson	4.2	125	0.65	0.62	6.9	1	3.0	75	2.1	96.0

Continued on next page

Electronic Filing: Received, Clerk's Office 3/24/2022

Analysis no.	County	Sm	Sr	Ta	Tb	Th	Tl	U	V	Yb	Zn
R19563	Henderson	4.6	135	0.72	0.66	7.6	<1	2.7	93	2.4	53.0
R19544	Henry	4.7	110	0.84	0.69	8.3	1	3.5	95	2.6	58.0
R19545	Henry	5.3	120	0.94	0.76	10.2	<1	3.4	132	2.8	62.0
R19546	Henry	5.5	115	1.10	0.77	10.0	1	4.5	135	3.0	67.0
R19547	Henry	6.3	125	0.97	0.84	10.0	<1	3.9	122	3.1	69.0
R19548	Henry	6.9	125	1.00	1.00	11.0	<1	3.4	159	3.5	124.0
R19549	Henry	6.3	130	0.88	0.90	9.6	1	2.7	114	3.2	63.0
R18689	Jackson	5.4	100	1.10	0.83	9.7	2	3.6	89	3.0	185.0
R18690	Jackson	5.2	110	1.00	0.76	12.0	2	4.0	115	2.9	74.0
R19529	Jo Daviess	4.6	115	0.96	0.62	8.4	1	3.0	104	2.6	51.0
R19530	Jo Daviess	6.4	110	1.10	0.89	11.0	<1	3.0	126	3.2	59.0
R19531	Jo Daviess	4.6	120	0.90	0.64	9.4	1	3.0	107	2.5	258.0
R19532	Jo Daviess	6.3	120	0.95	0.85	11.0	<1	3.4	112	2.9	132.0
R19519	Kane	5.3	95	0.88	0.75	9.5	1	3.2	85	2.7	66.0
R19520	Kane	6.1	100	0.77	0.90	8.9	1	3.6	139	2.9	61.0
R19582	Kane	5.7	95	0.90	0.74	9.8	<1	3.1	118	2.5	89.0
R19583	Kane	3.0	90	0.40	0.42	4.4	1	3.0	41	1.4	94.0
R19473	Kankakee	2.6	85	0.51	0.39	5.0	2	2.0	35	1.5	62.0
R19474	Kankakee	2.1	75	0.40	0.29	4.2	1	2.0	53	1.2	36.0
R19465	Kendall	5.6	95	1.00	0.82	10.0	1	5.2	137	2.9	86.0
R19466	Kendall	6.4	115	0.99	1.00	11.0	1	4.8	96	3.1	86.0
R19586	Knox	5.4	120	0.98	0.73	10.0	1	3.1	106	2.7	104.0
R19587	Knox	5.7	115	1.00	0.78	11.0	1	2.6	119	3.0	73.0
R19588	Knox	5.7	115	0.94	0.79	10.0	1	4.2	77	2.9	80.0
R19589	Knox	6.2	110	1.00	0.80	11.0	1	3.6	127	2.9	85.0
R19584	LaSalle	4.4	55	0.84	0.52	7.2	1	2.0	37	1.9	87.0
R19585	LaSalle	5.7	60	0.98	0.67	9.1	1	3.1	62	2.4	80.0
R19471	Lake	4.7	95	0.67	0.67	7.5	1	4.0	91	2.3	103.0
R19472	Lake	5.7	80	0.54	0.89	6.8	1	3.7	72	2.4	144.0
R19475	Lake	4.9	80	0.90	0.68	8.8	1	3.3	79	2.4	76.0
R19476	Lake	4.4	90	0.62	0.58	7.1	1	3.2	78	2.0	64.0
R19477	Lake	8.2	80	0.88	1.10	11.0	1	4.3	81	3.5	102.0
R19478	Lake	4.2	90	0.63	0.57	7.1	1	3.5	105	2.0	64.0
R18788	Livingston	5.7	90	0.89	0.81	9.7	2	3.5	77	2.7	124.0
R18789	Livingston	6.2	85	0.91	0.90	10.0	2	3.4	100	2.9	99.0
R18458	# Logan	5.4	116	0.85	0.72	8.8	2	3.2	100	2.7	121.0
R18459	# Logan	7.2	120	0.88	0.92	9.7	3	3.5	104	3.5	75.0
R19590	Logan	6.3	100	0.96	0.86	10.0	1	3.0	83	3.3	119.0
R19591	Logan	6.8	100	0.93	0.93	10.0	1	3.0	106	3.3	87.0
R18630	Macon	5.3	100	0.97	0.80	9.3	1	4.1	78	2.8	83.6
R18631	Macon	7.4	100	0.89	1.00	9.9	1	3.0	108	3.1	70.6
R18695	Marion	4.4	95	0.98	0.71	8.5	2	3.9	50	2.6	46.1
R18696	Marion	5.3	85	0.98	0.73	12.0	1	2.5	148	2.6	73.4
R19596	Mason	1.3	75	0.19	0.20	2.0	1	1.3	22	0.8	25.0
R19597	Mason	1.4	70	0.21	0.20	2.2	1	<1.5	20	0.7	17.0
R19564	McDonough	4.8	105	1.10	0.69	9.8	<1	4.0	77	3.0	46.0
R19565	McDonough	5.6	100	0.94	0.75	12.0	1	4.4	138	2.8	97.0
R19479	McHenry	3.3	85	0.77	0.50	6.5	1	3.0	102	1.9	43.0
R19480	McHenry	4.8	85	0.71	0.71	8.4	1	3.6	168	2.2	63.0
R19521	McHenry	3.7	90	0.59	0.50	6.5	1	2.4	82	1.9	45.0
R19522	McHenry	3.2	95	0.51	0.48	5.1	1	2.0	71	1.5	26.0
R18452	McLean	5.5	99	0.99	0.76	9.6	2	3.6	62	2.7	91.0
R18453	McLean	7.2	105	1.00	0.97	11.0	2	3.7	88	3.2	91.0
R18454	McLean	5.1	96	0.96	0.71	8.8	2	3.5	63	2.6	64.0
R18455	& McLean	4.1	89	0.45	0.56	5.7	2	3.0	35	1.7	40.0
R18456	& McLean	6.1	103	1.00	0.82	9.8	2	3.1	92	2.8	87.0
R18457	McLean	5.4	101	1.10	0.77	10.0	3	4.0	84	2.7	76.0
R19592	Menard	4.7	115	0.98	0.74	8.4	1	4.0	73	2.7	44.0
R19593	Menard	5.9	120	0.90	0.84	9.4	1	2.4	71	3.0	50.0

Continued on next page



Electronic Filing: Received, Clerk's Office 3/24/2022

Analysis no.	County	Sm	Sr	Ta	Tb	Th	Tl	U	V	Yb	Zn
R19594	Menard	5.2	105	0.91	0.78	8.4	1	3.4	71	2.8	54.0
R19595	Menard	5.4	110	0.84	0.79	8.6	1	2.2	64	2.8	56.0
R19554	Mercer	5.5	115	0.88	0.72	9.0	<1	3.7	136	2.7	95.0
R19555	Mercer	5.6	120	1.00	0.76	11.0	1	3.2	144	2.8	84.0
R19700	Morgan	5.5	105	0.96	0.85	9.8	1	3.2	101	3.0	143.0
R19701	Morgan	5.4	90	0.95	0.74	11.0	1	3.0	109	2.8	82.2
R18794	Ogle	4.5	105	0.85	0.68	8.3	2	2.6	53	2.4	58.0
R18795	Ogle	3.9	90	0.65	0.54	7.9	2	2.4	45	1.8	43.0
R18796	Ogle	3.8	105	0.87	0.62	7.5	2	3.0	43	2.3	38.0
R18797	Ogle	3.6	85	0.65	0.47	7.6	1	2.0	63	1.9	55.0
R18640	Peoria	5.4	90	0.87	0.83	8.2	1	4.0	89	2.6	103.0
R18641	Peoria	4.8	140	0.74	0.69	7.6	1	3.0	136	2.2	59.2
R18642	Peoria	5.4	100	1.00	0.81	9.9	1	3.1	83	2.9	63.9
R18643	Peoria	6.7	110	1.10	0.88	11.0	1	3.0	99	3.2	77.3
R19538	Peoria	7.8	125	1.10	1.00	12.0	<1	3.2	260	3.4	149.0
R19539	Peoria	5.2	390	0.75	0.68	8.1	<1	3.5	183	2.4	35.0
R18691	Perry	4.4	85	1.00	0.65	10.0	2	3.2	76	2.8	43.4
R18692	Perry	8.1	120	1.10	1.20	11.0	1	3.0	99	3.9	62.9
R19690	Pike	5.3	165	0.75	0.78	8.1	<1	2.8	60	2.6	38.8
R19691	Pike	5.2	165	0.69	0.73	7.8	1	3.2	67	2.5	43.8
R19692	Pike	5.6	110	1.00	0.84	9.2	<1	3.8	68	3.0	49.8
R19693	Pike	5.8	110	1.00	0.73	11.0	<1	3.4	135	2.9	73.9
R18568	Rock Island	5.5	109	0.90	0.79	8.5	2	3.0	68	2.7	69.0
R18569	Rock Island	6.5	117	0.97	0.95	9.9	2	2.7	81	3.1	33.0
R19552	Rock Island	5.2	125	1.00	0.75	9.6	1	3.8	117	2.8	59.0
R19553	Rock Island	6.5	125	1.00	0.81	12.0	<1	3.5	167	3.0	89.0
R19556	Rock Island	4.7	110	0.92	0.71	9.0	1	<4	95	2.7	84.0
R19557	Rock Island	5.8	115	0.95	0.71	12.0	<1	5.0	125	2.7	87.0
R19696	Sangamon	5.6	115	0.90	0.81	8.5	2	3.0	88	3.0	42.9
R19697	Sangamon	5.6	100	0.84	0.78	8.7	1	2.9	142	2.8	60.4
R19706	Schuyler	5.4	105	0.99	0.77	9.7	1	3.4	71	2.8	73.4
R19707	Schuyler	6.0	95	0.98	0.78	11.0	<1	3.6	97	2.9	94.2
R19694	Scott	6.4	110	1.00	0.84	10.0	1	3.3	91	3.1	62.6
R19695	Scott	7.1	100	1.00	1.00	11.0	1	3.1	95	3.4	83.8
R18817	Stark	5.4	115	0.96	0.76	9.2	2	3.0	56	2.9	65.0
R18818	Stark	7.5	120	1.00	0.99	11.0	2	3.0	141	3.2	73.0
R19527	Stephenson	4.1	100	0.61	0.60	6.3	<1	3.0	62	2.0	50.0
R19528	Stephenson	5.0	115	0.88	0.78	8.9	<1	3.3	98	2.7	62.0
R18636	Tazewell	5.1	100	0.90	0.76	9.5	1	3.5	105	2.7	92.2
R18637	Tazewell	5.1	90	1.10	0.72	12.0	2	3.6	117	2.5	86.6
R18823	Vermilion	5.6	85	0.95	0.79	10.0	2	3.3	110	2.8	98.0
R18824	Vermilion	6.2	110	0.89	0.84	9.9	2	3.2	114	2.7	79.0
R19373	Vermilion	5.2	80	0.91	0.74	9.1	3	3.4	65	2.5	84.0
R19374	Vermilion	6.2	70	0.99	0.89	11.0	3	5.0	88	2.9	87.0
R19375	Vermilion	5.5	100	0.95	0.84	9.5	2	4.0	59	2.8	143.0
R19376	^ Vermilion	7.0	105	0.94	0.96	10.0	2	3.4	64	3.2	73.0
R19558	Warren	6.0	90	0.87	0.79	9.3	<1	2.0	91	2.7	76.0
R19559	Warren	5.9	100	0.86	0.80	9.3	1	2.7	101	2.8	87.0
R19560	Warren	5.1	125	0.99	0.71	9.2	<1	3.3	69	3.0	41.0
R19561	Warren	6.8	120	0.95	0.94	11.0	1	3.7	112	3.2	76.0
R19379	Washington	6.0	120	1.00	0.85	9.8	1	6.1	66	3.1	35.0
R19380	Washington	6.3	150	0.98	0.92	11.0	1	5.0	128	3.0	73.0
R19383	Washington	5.1	95	0.94	0.74	8.5	2	3.1	69	2.8	23.0
R19384	Washington	4.7	90	0.84	0.66	8.2	1	3.9	65	2.6	43.0
R19385	Washington	4.3	95	1.00	0.65	8.7	<1	5.0	100	2.7	27.0
R19386	Washington	5.0	105	1.10	0.67	12.0	<1	5.7	138	2.8	69.0
R19540	Whiteside	4.7	110	0.73	0.71	7.7	1	3.0	142	2.5	141.0
R19541	Whiteside	4.9	110	0.79	0.68	8.2	<1	3.0	146	2.5	131.0

Continued on next page

Electronic Filing: Received, Clerk's Office 3/24/2022

Analysis no.	County	Sm	Sr	Ta	Tb	Th	Tl	U	V	Yb	Zn
R19542	Whiteside	5.4	135	1.00	0.81	9.0	<1	3.6	165	2.9	61.0
R19543	Whiteside	6.0	135	0.88	0.86	10.0	1	3.3	150	3.0	77.0
R19461	Will	4.8	85	0.97	0.70	9.3	1	5.4	100	2.6	71.0
R19462	Will	6.5	95	0.87	0.88	10.0	1	4.2	132	2.8	73.0
R19463	Will	4.6	90	0.98	0.67	9.1	2	4.7	98	2.4	69.0
R19464	Will	6.4	90	0.80	0.86	9.8	2	3.7	127	2.6	101.0
R18687	Williamson	5.3	95	1.00	0.72	10.0	2	3.5	89	3.0	59.0
R18688	Williamson	5.7	105	1.10	0.76	12.0	2	3.6	101	3.1	74.3
R19525	Winnebago	4.1	85	0.71	0.66	7.0	<1	2.5	88	2.2	42.0
R19526	Winnebago	5.6	105	0.91	0.75	9.7	1	2.0	103	2.8	48.0
R18819	Woodford	6.2	110	0.85	0.83	9.3	2	3.0	88	2.9	48.0
R18820	Woodford	6.6	110	0.88	0.91	9.2	1	3.5	95	3.0	54.0
Quality control replicate samples											
R19536	Kane	5.1	100	0.86	0.79	8.9	1	3.5	116	2.6	69.0
R19519		5.3	95	0.88	0.75	9.5	1	3.2	85	2.7	66.0
R19537	Kane	6.1	100	0.78	0.83	8.4	1	3.5	197	2.7	65.0
R19520		6.1	100	0.77	0.90	8.9	1	3.6	139	2.9	61.0
R19550	Henry	5.7	115	1.00	0.81	10.0	<1	2.4	137	3.1	64.0
R19546		5.5	115	1.10	0.77	10.0	1	4.5	135	3.0	67.0
R19551	Henry	6.3	125	0.94	0.81	10.0	1	3.0	140	3.0	65.0
R19547		6.3	125	0.97	0.84	10.0	<1	3.9	122	3.1	69.0
R19686	Logan	5.9	105	1.00	0.90	10.0	1	3.1	93	3.2	114.0
R19590		6.3	100	0.96	0.86	10.0	1	3.0	83	3.3	119.0
R19687	Logan	6.9	105	0.96	0.91	10.0	1	2.5	97	3.3	79.0
R19591		6.8	100	0.93	0.93	10.0	1	3.0	106	3.3	87.0

**APPENDIX 2—API NUMBER, CORE IDENTIFICATION, COUNTY, SOIL TYPE, LOCATION,  
ELEVATION, DEPTH OF CORE, DATE COLLECTED, AND NUMBER OF SUBSAMPLES  
(DREHER AND FOLLMER SERIES)**

Note: Location and elevation information were determined by GPS.

API no.	Core ID	County	Soil type	Latitude	Longitude	Elevation (m)	Depth of core (m)	Date collected	Subsamples (n)
120012297200	60	Adams	Keomah	40.015242	-91.104389	223.6	7.3	10/18/2000	6
120052333000	29	Bond	Darmstadt-Oconee	38.850455	-89.573899	166.8	6.1	10/26/1999	6
120072414900	125	Boone	Drummer	42.349611	-88.792336	255.6	5.2	10/30/2002	6
120172093700	61	Brown	Rozetta	40.006908	-90.720873	202.3	5.2	10/18/2000	6
120112304300	106	Bureau	Catlin	41.178618	-89.577246	250.9	6.4	10/22/2002	6
120112304400	112	Bureau	Port Byron	41.481257	-89.583652	245.6	4.4	10/24/2002	6
120112304500	113	Bureau	Catlin	41.468611	-89.192140	208.9	5.9	10/24/2002	6
120152169600	118	Carroll	Fayette	42.058217	-89.973160	246.4	8.2	10/28/2002	6
120172093700	62	Cass	Plainfield	40.011596	-90.337232	144.2	5.3	10/19/2000	7
120192560700	65	Champaign	Flanagan	40.007914	-88.060343	204.6	5.2	10/23/2000	6
120192572100	70	Champaign	Drummer	40.296726	-88.059279	221.3	4.1	10/24/2000	6
120192572000	71	Champaign	Drummer	40.295449	-88.441568	231.7	4.4	10/25/2000	6
120192563700	76	Champaign	Flanagan	40.009423	-88.439867	211.0	4.3	10/26/2000	6
120212496400	49	Christian	Virден	39.434546	-89.206144	200.3	4.9	11/04/1999	6
120212496500	54	Christian	Ipava	39.726182	-89.201425	180.4	5.7	10/16/2000	6
120232668400	36	Clark	Stoy	39.424327	-87.698352	183.2	3.7	10/28/1999	6
120252862700	32	Clay	Wynoose	38.848358	-88.455237	155.0	6.0	10/27/1999	6
120472449300	18	Clinton	Cowden	38.560363	-89.573221	135.4	5.3	11/20/1998	6
120272665500	19	Clinton	Hoyleton	38.558347	-89.198909	144.4	5.0	12/01/1998	6
120292424900	37	Coles	Xenia	39.427843	-88.064358	218.9	5.0	10/28/1999	6
120292425200	51	Coles	Toronto	39.430396	-88.448612	231.0	6.7	11/04/1999	6
120313433500	128	Cook	Alvin	41.757262	-87.638733	183.2	6.1	10/27/2003	6
120313444300	130	Cook	Mundelein	42.048007	-88.018908	211.0	6.1	10/28/2003	6
120333663900	35	Crawford	Muren	39.127023	-87.703158	150.9	4.6	10/28/1999	6
120372349500	126	DeKalb	Drummer	42.052380	-88.802055	262.1	5.8	10/30/2002	6
120372352700	134	DeKalb	Flanagan	41.763661	-88.802275	267.3	5.3	10/29/2003	6
120412281800	52	Douglas	Drummer	39.722746	-88.440921	199.1	4.3	10/16/2000	6
120412283600	66	Douglas	Toronto	39.723015	-88.073339	195.6	5.1	10/23/2000	6
120433146200	129	DuPage	Markham	41.756448	-88.017789	223.8	6.1	10/28/2003	6
120452320800	67	Edgar	Wingate	39.704526	-87.685549	198.0	5.2	10/23/2000	6
120472449300	22	Edwards	Belknap	38.549137	-88.101689	127.6	3.3	12/02/1998	6
120472449400	24	Edwards	Hosmer	38.267407	-88.095054	130.8	4.6	11/18/1998	6
120492479100	39	Effingham	Bluford	39.137876	-88.453636	176.1	4.8	10/29/1999	6
120512724500	30	Fayette	Bluford	38.854295	-89.200161	147.9	5.6	10/26/1999	5
120512797300	31	Fayette	Atlas	38.851078	-88.834686	170.7	4.8	10/26/1999	6
120512797400	40	Fayette	Bluford	39.136717	-88.830023	185.1	4.9	11/01/1999	6
120512801500	41	Fayette	Oconee	39.142615	-89.201557	194.4	6.9	11/01/1999	6
120532115700	89	Ford	Milford	40.602653	-88.427832	238.9	2.9	10/29/2001	6
120552465900	11	Franklin	Bonnie	37.979042	-88.835493	123.6	6.6	11/17/1998	6
120572480100	79	Fulton	Fayette	40.305260	-90.339493	156.8	7.0	10/23/2001	6
120572480200	84	Fulton	Rozetta	40.597824	-90.343331	158.0	5.0	10/30/2001	6
120572480300	85	Fulton	Hickory	40.591480	-89.954004	173.2	5.3	10/30/2001	6
120612110900	46	Greene	Muscatine	39.433275	-90.335362	165.4	6.7	11/03/1999	6
120632434700	103	Grundy	Reddick	41.182392	-88.426200	189.1	1.1	10/21/2002	5
120652535900	12	Hamilton	Zipp	37.974941	-88.469335	115.1	6.8	11/17/1998	6
120672132400	81	Hancock	Ipava	40.297711	-91.102245	160.0	4.3	10/23/2001	6
120672132500	82	Hancock	Atterberry	40.603934	-91.108535	158.3	7.0	10/24/2001	6
120732331400	107	Henry	Hickory	41.180811	-90.348791	238.7	5.0	10/22/2002	6
120732327500	108	Henry	Ipava	41.476641	-90.352822	246.1	7.3	10/22/2002	6
120732331500	110	Henry	Dickinson	41.184560	-89.964188	179.9	6.0	10/23/2002	6
120732331600	111	Henry	Selma	41.475551	-89.970725	185.5	3.9	10/23/2002	6
120752315600	97	Iroquois	Milford	40.873427	-88.035141	201.0	6.3	11/02/2001	6

*Continued on next page*

Electronic Filing: Received, Clerk's Office 3/24/2022

API no.	Core ID	County	Soil type	Latitude	Longitude	Elevation (m)	Depth of core (m)	Date collected	Subsamples (n)
120752315700	99	Iroquois	Watseka	40.874969	-87.659609	195.2	2.0	11/05/2001	6
120752315500	100	Iroquois	Lisbon	40.584738	-87.656844	209.8	2.7	11/13/2001	6
120752315200	101	Iroquois	Rutland	40.588303	-88.050844	212.0	4.3	11/05/2001	6
120772615300	8	Jackson	Belknap	37.685666	-89.210446	130.7	3.7	11/13/1998	6
120792531200	38	Jasper	Hoyleton	39.134259	-88.078135	176.0	5.8	10/29/1999	6
120812502100	26	Jefferson	Bluford	38.267509	-88.838011	151.1	3.0	11/18/1998	6
120832065300	44	Jersey	Keomah	39.142857	-90.330052	174.2	6.2	11/02/1999	6
120852309900	119	Jo Daviess	Fayette	42.345785	-90.357440	247.9	3.3	10/29/2002	6
120852310000	120	Jo Daviess	Atterberry	42.355471	-89.970268	289.2	4.0	10/29/2002	6
120872070300	3	Johnson	Hosmer	37.390018	-88.848546	148.6	3.6	10/11/1998	7
120893583400	133	Kane	Millbrook	42.052799	-88.406925	275.6	6.1	10/29/2003	6
120893583300	135	Kane	Saybrook	41.760599	-88.409256	169.0	6.1	10/29/2003	6
120912605600	98	Kankakee	Plattville	41.153730	-87.647820	195.0	1.2	11/05/2001	6
120912635800	102	Kankakee	Kankakee	41.174940	-88.037394	190.1	1.1	10/21/2002	6
120932442500	136	Kendall	Plattville	41.471238	-88.412526	206.9	4.0	10/29/2003	6
120952341400	91	Knox	Tama	40.887055	-90.347278	229.4	6.6	10/31/2001	6
120974909200	131	Lake	Grays-Markham	42.338409	-88.009593	242.1	6.1	10/28/2003	6
120992719000	104	LaSalle	Elburn	41.179872	-88.816312	198.6	4.9	10/21/2002	6
120992720000	114	LaSalle	Muscatine	41.472404	-88.806696	191.5	4.0	10/24/2002	6
121012976700	34	Lawrence	Ava	38.836222	-87.710588	154.9	4.2	10/27/1999	6
121032349800	115	Lee	Hartsburg	41.771976	-89.180776	226.9	3.8	10/25/2002	6
121032349900	116	Lee	Dakota	41.768891	-89.582236	207.9	6.2	10/25/2002	6
121052306000	95	Livingston	Ashkum	40.884522	-88.814097	198.3	4.6	11/02/2001	6
121052306100	96	Livingston	Ashkum	40.885324	-88.432739	209.3	4.0	11/02/2001	6
121072267900	64	Logan	Sawmill	40.017497	-89.576698	182.0	6.0	10/19/2000	6
121072271200	74	Logan	Sable	40.016780	-89.199948	195.3	6.7	10/26/2000	6
121072271300	77	Logan	Broadwell	40.307537	-89.579540	145.4	7.3	10/22/2001	6
121152296900	75	Macon	Catlin	40.009528	-88.821598	205.3	4.3	10/26/2000	6
121172396300	43	Macoupin	Harrison	39.141219	-89.942085	195.8	6.3	11/02/1999	6
121172396400	47	Macoupin	Wakeland	39.433705	-89.953232	175.0	6.2	11/03/1999	6
121192767000	28	Madison	Beaucoup	38.849167	-89.949326	134.6	6.5	10/25/1999	6
121212798900	20	Marion	Ava	38.552245	-88.837449	172.4	4.5	12/01/1998	6
121252200800	78	Mason	Onarga	40.307996	-89.957537	120.1	4.3	10/22/2001	6
121092283800	80	McDonough	Wakeland	40.302203	-90.734718	131.4	6.1	10/23/2001	6
121092283900	83	McDonough	Ipava	40.597140	-90.731382	231.6	6.7	10/31/2001	6
121114189600	132	McHenry	Ringwood	42.343684	-88.411511	274.3	6.1	10/28/2003	6
121132388700	72	McLean	Ipava	40.308790	-88.814788	240.9	5.0	10/25/2000	6
121132388800	73	McLean	Catlin	40.307093	-89.196729	223.6	3.2	10/25/2000	6
121132388900	88	McLean	Elkhart	40.601511	-88.812850	232.9	2.8	10/29/2001	6
121152296800	53	Menard	Drummer	39.724588	-88.821472	207.7	2.9	10/16/2000	6
121292150900	63	Menard	Arenzville	40.011047	-89.955365	160.9	6.1	10/19/2000	5
121312173700	109	Mercer	Hickory	41.178938	-90.728307	207.1	5.2	10/23/2002	6
121332276500	16	Monroe	Marine	38.268573	-89.937675	131.6	4.6	11/19/1998	6
121332276600	17	Monroe	Riley	38.266580	-90.320468	119.6	5.2	11/20/1998	5
121352396500	42	Montgomery	Ross	39.142791	-89.577299	167.7	5.8	11/01/1999	6
121352396600	48	Montgomery	Herrick	39.434568	-89.570377	199.1	6.1	11/03/1999	6
121372196600	57	Morgan	Rozetta	39.715170	-90.330943	192.6	6.4	10/17/2000	6
121412520700	122	Ogle	Tama	42.060445	-89.575460	277.1	6.3	10/29/2002	6
121412521100	123	Ogle	Assumption	42.052144	-89.188936	216.8	5.1	10/30/2002	6
121433425800	92	Peoria	Rozetta	40.893094	-89.964791	215.1	5.5	11/01/2001	6
121433425900	93	Peoria	Strawn	40.885883	-89.585775	203.6	3.7	11/01/2001	6
121452888100	9	Perry	Stoy	37.984185	-89.576625	151.9	3.8	11/16/1998	6
121452888000	10	Perry	Hoyleton/Dar	37.979585	-89.208011	122.9	4.3	11/16/1998	6
121492163500	45	Pike	Fayette	39.429489	-90.703425	224.0	6.1	11/02/1999	6
121492163600	58	Pike	Sable	39.720517	-90.707900	188.8	6.7	10/17/2000	6
121492163700	59	Pike	Fayette	39.714684	-91.087109	203.3	2.7	10/18/2000	6
121512058200	4	Pope	Hurst	37.099175	-88.490821	106.1	3.5	10/11/1998	6
121512058100	5	Pope	Hosmer	37.376320	-88.487481	166.5	2.8	10/12/1998	6

Continued on next page

## Electronic Filing: Received, Clerk's Office 3/24/2022

API no.	Core ID	County	Soil type	Latitude	Longitude	Elevation (m)	Depth of core (m)	Date collected	Subsamples (n)
121532089400	1	Pulaski	Karnak	37.105069	-89.217420	102.0	6.7	10/11/1998	6
121552070100	105	Putnam	Catlin	41.179263	-89.198828	210.1	4.9	10/21/2002	6
121592589500	33	Richland	Cisne	38.843130	-88.085053	145.7	4.3	10/27/1999	6
121652658400	6	Saline	Hurst	37.683796	-88.472848	112.8	4.9	10/12/1998	6
121672620000	55	Sangamon	Radford	39.709922	-89.576828	166.8	6.7	10/16/2000	6
121672620100	56	Sangamon	Sable	39.723535	-89.956388	197.9	6.3	10/17/2000	6
121732396700	50	Shelby	Dana	39.433311	-88.824085	191.7	5.8	11/04/1999	6
121632978200	27	St. Clair	Fayette	38.562054	-89.946805	127.8	6.4	10/25/1999	6
121772289500	121	Stephenson	Huntsville	42.359635	-89.573724	276.7	3.0	10/29/2002	6
121792446100	86	Tazewell	Stronghurst	40.601655	-89.576662	200.1	6.7	10/30/2001	6
121812148400	2	Union	Hosmer	37.395835	-89.210001	183.3	6.1	10/12/1998	7
121832554700	68	Vermilion	Flanagan	39.996363	-87.675479	213.4	4.8	10/24/2000	6
121832566600	69	Vermilion	Elliott	40.295438	-87.674530	211.1	4.3	10/24/2000	6
121852812300	23	Wabash	Hosmer	38.546208	-87.719452	137.5	6.6	12/02/1998	6
121872166500	90	Warren	Muscatine	40.891184	-90.720034	236.5	7.3	10/31/2001	6
121892465200	14	Washington	Bluford	38.259353	-89.210879	163.5	6.2	11/19/1998	6
121892465300	15	Washington	Bluford	38.277243	-89.566780	155.6	5.4	11/19/1998	6
121913265200	21	Wayne	Wynoose	38.549470	-88.466462	145.9	4.6	12/02/1998	6
121913265300	25	Wayne	Bonnie	38.262685	-88.467901	118.2	6.9	11/18/1998	6
121933198400	13	White	Alvin	37.972826	-88.100317	113.7	4.6	11/17/1998	5
121952334800	117	Whiteside	Otter	41.771734	-89.968303	187.0	6.1	10/28/2002	6
120313433400	127	Will	Martinton	41.472741	-87.645405	214.8	6.1	10/27/2003	6
121974143500	137	Will	Ashkum	41.467279	-88.031479	200.6	6.1	10/30/2003	6
121992396000	7	Williamson	Ava	37.691467	-88.844336	150.8	4.2	11/13/1998	5
122013255100	124	Winnebago	Winnebago	42.343514	-89.185205	251.9	2.0	10/30/2002	6
122032228800	87	Woodford	Rozetta	40.600952	-89.199600	229.3	5.3	10/29/2001	6
122032228900	94	Woodford	Drummer	40.887416	-89.198048	216.5	4.9	11/01/2001	6

Electronic Filing: Received, Clerk's Office 3/24/2022



**APPENDIX 3—CORE IDENTIFICATION, COUNTY, SOIL TEXTURE, SOIL TYPE, SOIL ASSOCIATION, AND LAND USE (DREHER AND FOLLMER SERIES)**

Core ID	County	Texture	Soil type	Soil association	Land use
60	Adams	Silt loam	Keomah	Clinton-Keomah-Rushville	Upland, forest
29	Bond	Silt loam	Darmstadt-Oconee	Oconee-Cowden-Piasa	Upland, prairie
125	Boone	Silt loam	Drummer	Catlin-Flanagan-Drummer	Upland, prairie
61	Brown	Silt loam	Rozetta	Fayette-Rozetta-Stronghurst	Upland, forest
106	Bureau	Silty clay loam	Catlin	Catlin-Flanagan-Drummer	Upland, prairie
112	Bureau	Silt loam	Port Byron	Port Byron-Joy	Upland, prairie
113	Bureau	Silty clay loam	Catlin	Catlin-Flanagan-Drummer	Upland, prairie
118	Carroll	Silt loam	Fayette	Fayette-Rozetta-Stronghurst	Upland, forest
62	Cass	Loamy sand	Plainfield	Oakville-Lamont-Alvin	Aeolian, prairie
65	Champaign	Silt loam	Flanagan	Catlin-Flanagan-Drummer	Upland, prairie
70	Champaign	Silty clay loam	Drummer	Catlin-Flanagan-Drummer	Upland, prairie
71	Champaign	Silt loam	Drummer	Catlin-Flanagan-Drummer	Upland, prairie
76	Champaign	Silt loam	Flanagan	Catlin-Flanagan-Drummer	Upland, prairie
49	Christian	Silt loam	Virden	Herrick-Virden-Piasa	Upland, prairie
54	Christian	Silt loam	Ipava	Tama-Ipava-Sable	Upland, prairie
36	Clark	Silt loam	Stoy	Hosmer-Stoy-Weir	Upland, forest
32	Clay	Silt loam	Wynoose	Ava-Bluford-Wynoose	Upland, forest
18	Clinton	Silt loam	Cowden	Oconee-Cowden-Piasa	Prairie
19	Clinton	Silt loam	Hoyleton	Hoyleton-Cisne-Huey	Prairie
37	Coles	Silt loam	Xenia	Dodge-Russell-Miami	Upland, forest
51	Coles	Silt loam	Toronto	Dodge-Russell-Miami	Upland, forest
128	Cook	Loam	Alvin	Oakville-Lamont-Alvin	Aeolian, forest
130	Cook	Silty clay loam	Mundelein	Plano-Proctor-Worthen	Alluvium, prairie
35	Crawford	Silt loam	Muren	Alford-Muren-Iva	Upland, forest
126	DeKalb	Silty clay loam	Drummer	Catlin-Flanagan-Drummer	Upland, prairie
134	DeKalb	Silt loam	Flanagan	Catlin-Flanagan-Drummer	Upland, prairie
52	Douglas	Silty clay loam	Drummer	Catlin-Flanagan-Drummer	Upland, prairie
66	Douglas	Silt loam	Toronto	Dodge-Russell-Miami	Upland, forest
129	DuPage	Silty clay loam	Markham	Marley-Blount-Beecher	Upland, forest
67	Edgar	Loam	Wingate	Dodge-Russell-Miami	Upland, forest
22	Edwards	Silt loam	Belknap	Haymond-Petrolia-Karnak	Alluvial, forest
24	Edwards	Silt loam	Hosmer	Hosmer-Stoy-Weir	Upland, forest
39	Effingham	Silt loam	Bluford	Ava-Bluford-Wynoose	Upland, forest
30	Fayette	Silt loam	Bluford	Ava-Bluford-Wynoose	Upland, forest
31	Fayette	Clay loam	Atlas	Fayette-Rozetta-Stronghurst	Upland, forest
40	Fayette	Silt loam	Bluford	Ava-Bluford-Wynoose	Upland, forest
41	Fayette	Silt loam	Oconee	Oconee-Cowden-Piasa	Upland, prairie
89	Ford	Silty clay loam	Milford	Martinton-Milford	Lacustrine, prairie
11	Franklin	Silt loam	Bonnie	Haymond-Petrolia-Karnak	Alluvial, forest
79	Fulton	Silt loam	Fayette	Fayette-Rozetta-Stronghurst	Upland, forest
84	Fulton	Silt loam	Rozetta	Fayette-Rozetta-Stronghurst	Upland, forest
85	Fulton	Silt loam	Hickory	Fayette-Rozetta-Stronghurst	Upland, forest
46	Greene	Silt loam	Muscatine	Tama-Muscatine-Sable	Upland, prairie
103	Grundy	Silty clay loam	Reddick	Symerton-Andres-Reddick	Upland, prairie
12	Hamilton	Silty clay loam	Zipp	Markland-Colp-Del Rey	Lacustrine, forest
81	Hancock	Silt loam	Ipava	Tama-Ipava-Sable	Upland, prairie
82	Hancock	Silt loam	Atterberry	Fayette-Rozetta-Stronghurst	Upland, forest
107	Henry	Silty clay loam	Hickory	Fayette-Rozetta-Stronghurst	Upland, forest
108	Henry	Silty clay loam	Ipava	Tama-Ipava-Sable	Upland, prairie
110	Henry	Sandy loam	Dickinson	Fayette-Rozetta-Stronghurst	Upland, forest
111	Henry	Loam	Selma	Jasper-LaHogue-Selma	Upland, prairie
97	Iroquois	Clay loam	Milford	Martinton-Milford	Lacustrine, prairie
99	Iroquois	Sandy loam	Watseka	Sparta-Dickinson-Onarga	Upland, prairie
100	Iroquois	Silt loam	Lisbon	Saybrook-Dana-Drummer	Upland, prairie
101	Iroquois	Silty clay loam	Rutland	Wenona-Rutland-Streator	Upland, prairie
8	Jackson	Silt loam	Belknap	Haymond-Petrolia-Karnak	Alluvial, forest

Continued on next page

Electronic Filing: Received, Clerk's Office 3/24/2022

Core ID	County	Texture	Soil type	Soil association	Land use
38	Jasper	Silt loam	Hoyleton	Hoyleton-Cisne-Huey	Upland, prairie
26	Jefferson	Silt loam	Bluford	Ava-Bluford-Wynoose	Alluvial, forest
44	Jersey	Silt	Keomah	Clinton-Keomah-Rushville	Upland, forest
119	Jo Daviess	Silt loam	Fayette	Fayette-Rozetta-Stronghurst	Upland, forest
120	Jo Daviess	Silt loam	Atterberry	Fayette-Rozetta-Stronghurst	Upland, forest
3	Johnson	Silt loam	Hosmer	Hosmer-Stoy-Weir	Upland forest
133	Kane	Silt loam	Millbrook	St. Charles-Camden-Drury	Upland, forest
135	Kane	Silty clay loam	Saybrook	Saybrook-Dana-Drummer	Upland, prairie
98	Kankakee	Loam	Plattville	Channahon-Dodgeville-Ashdale	Upland, prairie
102	Kankakee	Loam	Kankakee	Channahon-Dodgeville-Ashdale	Upland, prairie
136	Kendall	Silty clay loam	Plattville	Channahon-Dodgeville-Ashdale	Upland, prairie
91	Knox	Silt loam	Tama	Tama-Muscatine-Sable	Upland, prairie
131	Lake	Silty clay loam	Grays-Markham	St. Charles-Camden-Drury	Upland, forest
104	LaSalle	Silty clay loam	Elburn	Plano-Proctor-Worthen	Upland, prairie
114	LaSalle	Silty clay loam	Muscatine	Tama-Muscatine-Sable	Upland, prairie
34	Lawrence	Silt loam	Ava	Ava-Bluford-Wynoose	Upland, forest
115	Lee	Silt loam	Hartsburg	Tama-Ipava-Sable	Upland, prairie
116	Lee	Loam	Dakota	Lorenzo-Warsaw-Wea	Upland, prairie
95	Livingston	Silty clay loam	Ashkum	Varna-Elliott-Ashkum	Upland, prairie
96	Livingston	Silty clay loam	Ashkum	Varna-Elliott-Ashkum	Upland, prairie
64	Logan	Silt loam	Sawmill	Lawson-Sawmill-Darwin	Alluvium, prairie
74	Logan	Silty clay loam	Sable	Tama-Ipava-Sable	Upland, prairie
77	Logan	Silt loam	Broadwell	Broadwell-Waukegan-Pillot	Upland, prairie
75	Macon	Silt loam	Catlin	Catlin-Flanagan-Drummer	Upland, prairie
43	Macoupin	Silt	Harrison	Herrick-Virden-Piasa	Upland, prairie
47	Macoupin	Silt loam	Wakeland	Haymond-Petrolia-Karnak	Alluvial, forest
28	Madison	Silt loam	Beaucoup	Lawson-Sawmill-Darwin	Alluvial, prairie
20	Marion	Silt loam	Ava	Ava-Bluford-Wynoose	Upland, forest
78	Mason	Loamy sand	Onarga	Sparta-Dickinson-Onarga	Upland, prairie
80	McDonough	Loam	Wakeland	Haymond-Petrolia-Karnak	Alluvium, forest
83	McDonough	Silty clay loam	Ipava	Tama-Ipava-Sable	Upland, prairie
132	McHenry	Silt loam	Ringwood	Griswold-Ringwood	Upland, prairie
72	McLean	Silty clay loam	Ipava	Tama-Ipava-Sable	Upland, prairie
73	McLean	Silt loam	Catlin	Catlin-Flanagan-Drummer	Upland, prairie
88	McLean	Silty clay loam	Elkhart	Tama-Ipava-Sable	Upland, prairie
53	Menard	Silt loam	Drummer	Catlin-Flanagan-Drummer	Upland, prairie
63	Menard	Silt loam	Arenzvill	Haymond-Petrolia-Karnak	Alluvium, forest
109	Mercer	Silt loam	Hickory	Fayette-Rozetta-Stronghurst	Upland, forest
16	Monroe	Silty clay loam	Marine	Alford-Muren-Iva	Upland, forest
17	Monroe	Silty clay loam	Riley	Lawson-Sawmill-Darwin	Alluvial, prairie
42	Montgomery	Silt loam	Ross	Lawson-Sawmill-Darwin	Alluvial, prairie
48	Montgomery	Silt loam	Herrick	Herrick-Virden-Piasa	Upland, prairie
57	Morgan	Silt loam	Rozetta	Fayette-Rozetta-Stronghurst	Upland, forest
122	Ogle	Silt loam	Tama	Tama-Muscatine-Sable	Upland, prairie
123	Ogle	Silt loam	Assumption	Tama-Muscatine-Sable	Upland, prairie
92	Peoria	Silty clay loam	Rozetta	Fayette-Rozetta-Stronghurst	Upland, forest
93	Peoria	Silt loam	Strawn	Dodge-Russell-Miami	Upland, forest
9	Perry	Silt loam	Stoy	Hosmer-Stoy-Weir	Upland forest
10	Perry	Silt loam	Hoyleton/Dar	Hoyleton-Cisne-Huey	Upland prairie
45	Pike	Silt loam	Fayette	Fayette-Rozetta-Stronghurst	Upland, forest
58	Pike	Silt loam	Sable	Tama-Ipava-Sable	Upland, prairie
59	Pike	Silt loam	Fayette	Fayette-Rozetta-Stronghurst	Upland, forest
4	Pope	Silty clay loam	Hurst	Markland-Colp-DelRey	Lacustrine, forest
5	Pope	Silt loam	Hosmer	Hosmer-Stoy-Weir	Upland forest
1	Pulaski	Silty clay loam	Karnak	Haymond-Petrolia-Karnak	Alluvial, forest
105	Putnam	Silt loam	Catlin	Catlin-Flanagan-Drummer	Upland, prairie
33	Richland	Silt loam	Cisne	Hoyleton-Cisne-Huey	Upland, prairie
6	Saline	Silt loam	Hurst	Markland-Colp-DelRey	Lacustrine, forest

Continued on next page



## Electronic Filing: Received, Clerk's Office 3/24/2022

Core ID	County	Texture	Soil type	Soil association	Land use
55	Sangamon	Silt loam	Radford	Lawson-Sawmill-Darwin	Alluvium, prairie
56	Sangamon	Silty clay	Sable	Tama-Ipava-Sable	Upland, prairie
50	Shelby	Silty clay	Dana	Saybrook-Dana-Drummer	Upland, prairie
27	St. Clair	Silt	Fayette	Fayette-Rozetta-Stronghurst	Upland, forest
121	Stephenson	Silt loam	Huntsville	Lawson-Sawmill-Darwin	Alluvium, prairie
86	Tazewell	Silt loam	Stronghurst	Fayette-Rozetta-Stronghurst	Upland, forest
2	Union	Silt loam	Hosmer	Hosmer-Stoy-Weir	Upland forest
68	Vermilion	Silt loam	Flanagan	Catlin-Flanagan-Drummer	Upland, prairie
69	Vermilion	Silty clay loam	Elliott	Varna-Elliott-Ashkum	Upland, prairie
23	Wabash	Silt loam	Hosmer	Hosmer-Stoy-Weir	Upland, forest
90	Warren	Silt loam	Muscatine	Tama-Muscatine-Sable	Upland, prairie
14	Washington	Silt loam	Bluford	Ava-Bluford-Wynoose	Upland, forest
15	Washington	Silt loam	Bluford	Ava-Bluford-Wynoose	Upland, forest
21	Wayne	Silt loam	Wynoose	Ava-Bluford-Wynoose	Upland, forest
25	Wayne	Silt loam	Bonnie	Haymond-Petrolia-Karnak	Alluvial, forest
13	White	Sandy loam	Alvin	Oakville-Lamont-Alvin	Windblown sand
117	Whiteside	Silt loam	Otter	Lawson-Sawmill-Darwin	Alluvium, prairie
127	Will	Silty clay loam	Martinton	Martinton-Milford	Lacustrine, prairie
137	Will	Silty clay loam	Ashkum	Varna-Elliott-Ashkum	Upland, prairie
7	Williamson	Silt loam	Ava	Ava-Bluford-Wynoose	Upland forest
124	Winnebago	Sandy loam	Winnebago	Winnebago-Durand-Ogle	Upland, prairie
87	Woodford	Silt loam	Rozetta	Fayette-Rozetta-Stronghurst	Upland, forest
94	Woodford	Silty clay loam	Drummer	Catlin-Flanagan-Drummer	Upland, prairie

Electronic Filing: Received, Clerk's Office 3/24/2022

**APPENDIX 4—SAMPLE IDENTIFICATION; COUNTY; DEPTH INTERVAL;  
HORIZON; SAND, SILT, AND CLAY CONCENTRATIONS; AND SOIL TEXTURE  
(DREHER AND FOLLMER SERIES)**

Note: An asterisk (\*) indicates that an insufficient sample of core 15 was available to measure sand, silt, and clay contents.

Sample ID	County	Depth interval (m)	Horizon	Sand (%)	Silt (%)	Clay (%)	Texture
60-1	Adams	0.0–0.1	Ap	1.86	83.58	14.56	Silt loam
60-2	Adams	0.1–0.4	Ap2	1.50	84.06	14.44	Silt loam
60-3	Adams	0.4–0.5	E	3.70	83.90	12.40	Silt loam
60-6	Adams	0.6–0.9	Bt2	1.56	52.90	45.54	Silty clay
60-21	Adams	3.4–3.5	3Btt	18.99	46.51	34.50	Silty clay loam
60-40	Adams	7.2–7.3	3C	30.06	32.14	37.80	Clay loam
29-1	Bond	0.0–0.2	Ap	10.27	71.57	18.16	Silt loam
29-2	Bond	0.2–0.3	A1	6.82	74.04	19.14	Silt loam
29-3	Bond	0.3–0.4	Ae	5.28	77.50	17.22	Silt loam
29-4	Bond	0.4–0.7	E	2.90	67.04	30.06	Silty clay loam
29-9	Bond	2.1–2.4	C1	35.10	52.34	12.56	Silt loam
29-14	Bond	3.7–3.9	2A	64.61	18.25	17.14	Sandy loam
125-1	Boone	0.0–0.3	Ap1	8.31	69.23	22.46	Silt loam
125-2	Boone	0.3–0.4	Ap2	12.30	62.60	25.10	Silt loam
125-3	Boone	0.4–0.6	Bg	3.60	69.52	26.88	Silt loam
125-4	Boone	0.6–0.8	Bg	5.10	59.52	35.36	Silty clay loam
125-6	Boone	1.0–1.1	BCg	64.59	18.95	16.46	Silt loam
125-10	Boone	1.8–2.1	3C	43.92	38.54	17.54	Loam
61-1	Brown	0.0–0.2	Ap	8.48	70.88	20.64	Silt loam
61-2	Brown	0.2–0.4	Bt1	1.08	60.49	38.43	Silty clay loam
61-3	Brown	0.4–0.6	Bt1	0.32	63.96	35.72	Silty clay loam
61-4	Brown	0.6–0.8	Bt2	0.96	66.50	32.54	Silty clay loam
61-10	Brown	1.9–2.1	C	0.58	82.42	17.00	Silt loam
61-18	Brown	3.5–3.7	3Bt	15.46	48.48	36.06	Silty clay loam
106-1	Bureau	0.0–0.2	Ap	1.45	69.31	29.24	Silty clay loam
106-2	Bureau	0.2–0.4	BA	0.78	67.27	31.95	Silty clay loam
106-3	Bureau	0.4–0.6	Bt	1.27	70.95	27.78	Silty clay loam
106-4	Bureau	0.6–0.8	Bt	2.56	70.58	26.86	Silt loam
106-6	Bureau	1.0–1.2	B2tj	3.17	80.12	16.71	Silt loam
106-8	Bureau	1.3–1.5	C	4.42	85.82	9.76	Silt
112-1	Bureau	0.0–0.3	Ap1	3.26	77.42	19.32	Silt loam
112-3	Bureau	0.3–0.6	Btj	1.72	72.33	25.95	Silt loam
112-4	Bureau	0.6–0.7	Btj	2.50	71.48	26.02	Silt loam
112-6	Bureau	0.9–1.0	Btj	4.04	74.14	21.82	Silt loam
112-8	Bureau	1.2–1.4	BCtj	7.68	74.06	18.26	Silt loam
112-10	Bureau	1.5–1.7	C	11.28	69.44	19.28	Silt loam
113-1	Bureau	0.0–0.2	Ap	1.19	69.83	28.98	Silty clay loam
113-2	Bureau	0.2–0.4	Btj	0.99	63.81	35.20	Silty clay loam
113-3	Bureau	0.4–0.6	Bt	1.30	68.10	30.60	Silty clay loam
113-4	Bureau	0.6–0.7	Bt	1.96	74.29	23.76	Silt loam
113-5	Bureau	0.7–0.9	BCtj	2.32	81.96	15.72	Silt loam
113-6	Bureau	1.4–1.6	C	6.52	81.50	11.98	Silt
118-1	Carroll	0.0–0.3	Ap	3.68	80.22	16.10	Silt loam
118-2	Carroll	0.3–0.5	Btj	0.96	75.14	23.90	Silt loam
118-3	Carroll	0.5–0.6	Btj	1.56	71.86	26.58	Silt loam
118-5	Carroll	0.8–1.0	Bt	3.76	69.42	26.82	Silt loam
118-8	Carroll	1.4–1.6	Bt	3.00	70.38	26.62	Silt loam
118-11	Carroll	2.0–2.3	Ctj	1.36	81.68	16.96	Silt loam
62-1	Cass	0.0–0.2	Ap	84.06	13.34	2.60	Loamy sand
62-2	Cass	0.2–0.4	AB	84.99	12.29	2.72	Loamy sand
62-3	Cass	0.4–0.6	AB	83.33	13.18	3.40	Loamy sand
62-5	Cass	0.9–1.1	BA	84.26	12.78	2.96	Loamy sand
62-7	Cass	1.3–1.5	Bw	86.04	9.08	4.88	Loamy sand

*Continued on next page*

## Electronic Filing: Received, Clerk's Office 3/24/2022

Sample ID	County	Depth interval (m)	Horizon	Sand (%)	Silt (%)	Clay (%)	Texture
62-17	Cass	3.2-3.4	Bâ	89.78	2.94	7.28	Sand
62-18	Cass	3.4-3.5	C	95.54	2.82	1.72	Sand
65-1	Champaign	0.0-0.2	Ap	3.02	69.98	27.00	Silt loam
65-2	Champaign	0.2-0.4	A2	1.72	66.76	31.52	Silty clay loam
65-3	Champaign	0.4-0.6	BAt	1.65	61.35	37.00	Silty clay loam
65-4	Champaign	0.6-0.8	Bt	1.32	63.34	35.34	Silty clay loam
65-5	Champaign	0.8-1.1	Btj	4.36	68.46	27.18	Silty clay loam
65-11	Champaign	1.9-2.1	3C	26.49	49.33	24.18	Loam
70-1	Champaign	0.0-0.4	Ap	5.47	65.42	29.11	Silty clay loam
70-2	Champaign	0.4-0.6	A	20.40	46.52	33.08	Clay loam
70-3	Champaign	0.6-0.9	AB	24.44	40.74	34.82	Clay loam
70-4	Champaign	0.9-1.1	BA	26.66	41.46	31.88	Clay loam
70-5	Champaign	1.1-1.3	Bg	32.02	37.92	30.06	Clay loam
70-8	Champaign	1.7-2.0	B3â	66.53	21.17	12.30	Sandy loam
71-1	Champaign	0.0-0.2	Ap	7.06	67.75	25.19	Silt loam
71-2	Champaign	0.2-0.4	AB	1.09	66.21	32.70	Silty clay loam
71-3	Champaign	0.4-0.6	Btj	0.69	71.06	28.25	Silty clay loam
71-4	Champaign	0.6-0.7	CB	0.85	86.37	12.78	Silt loam
71-5	Champaign	0.7-0.9	C	0.88	89.66	9.60	Silt
71-10	Champaign	1.7-1.9	2C	12.16	51.27	36.52	Silty clay loam
76-1	Champaign	0.0-0.3	Ap	9.39	68.62	21.99	Silt loam
76-3	Champaign	0.4-0.6	Bt	4.19	58.42	37.39	Silty clay loam
76-4	Champaign	0.6-0.8	Bt	6.65	60.02	33.33	Silty clay loam
76-5	Champaign	0.8-1.0	Btj	5.32	68.24	26.44	Silt loam
76-6	Champaign	1.0-1.2	BC	8.36	66.38	25.26	Silt loam
76-8	Champaign	1.3-1.4	2Câ	42.15	36.20	21.65	Loam
49-1	Christian	0.0-0.2	Ap	3.66	72.83	23.51	Silt loam
49-2	Christian	0.2-0.4	Ap2	3.11	65.17	31.72	Silty clay loam
49-3	Christian	0.4-0.6	BAt	2.36	61.6	36.04	Silty clay loam
49-5	Christian	0.8-1.1	Bgt2	4.90	66.76	28.34	Silty clay loam
49-7	Christian	1.3-1.4	CBtj	0.54	80.55	18.91	Silt loam
49-21	Christian	3.8-4.0	Bg	30.08	44.17	25.75	Loam
54-1	Christian	0.0-0.2	Ap	7.13	68.08	24.79	Silt loam
54-3	Christian	0.4-0.6	AB	1.75	61.89	36.36	Silty clay loam
54-4	Christian	0.6-0.7	B1	1.99	63.22	34.79	Silty clay loam
54-5	Christian	0.7-0.9	Bt	1.02	68.15	30.83	Silty clay loam
54-7	Christian	1.1-1.2	C	0.46	85.96	13.58	Silt loam
54-14	Christian	2.2-2.4	2Ab	9.19	69.31	21.50	Silt loam
36-1	Clark	0.0-0.3	Ap	5.81	77.67	16.51	Silt loam
36-2	Clark	0.3-0.4	EB1	3.76	73.53	22.71	Silt loam
36-3	Clark	0.4-0.7	EB2	2.08	70.54	27.38	Silty clay loam
36-4	Clark	0.7-0.9	B1	2.64	70.10	27.26	Silty clay loam
36-6	Clark	1.4-1.6	Btx2	30.98	54.98	14.04	Silt loam
36-8	Clark	2.1-2.4	C1	43.18	28.87	27.95	Clay loam
32-1	Clay	0.0-0.2	Ap	16.73	65.40	17.87	Silt loam
32-2	Clay	0.2-0.5	Eg1	15.72	63.37	20.91	Silt loam
32-3	Clay	0.5-0.8	Eg2	16.12	62.32	21.56	Silt loam
32-4	Clay	0.8-1.4	Btg	12.60	50.40	37.00	Silty clay loam
32-6	Clay	1.4-2.1	C1	23.72	45.91	30.37	Clay loam
32-11	Clay	4.3-4.9	C6	43.50	39.65	16.85	Loam
18-01	Clinton	0.0-0.1	A	4.50	84.34	11.16	Silt loam
18-02	Clinton	0.1-0.2	A	4.11	84.68	11.21	Silt loam
18-03	Clinton	0.2-0.3	A	4.46	84.40	11.14	Silt loam
18-04	Clinton	0.3-0.5	E	5.02	84.44	10.54	Silt loam
18-10	Clinton	1.0-1.3	B	1.92	65.50	32.58	Silty clay
18-16	Clinton	2.4-3.1	C	25.50	54.54	19.96	Silt loam
19-01	Clinton	0.0-0.1	A	16.64	69.25	14.11	Silt loam
19-02	Clinton	0.1-0.2	A	5.50	79.10	15.40	Silt loam
19-03	Clinton	0.2-0.3	E	7.00	76.24	16.76	Silt loam

*Continued on next page*

Electronic Filing: Received, Clerk's Office 3/24/2022

Sample ID	County	Depth interval (m)	Horizon	Sand (%)	Silt (%)	Clay (%)	Texture
19-04	Clinton	0.3-0.4	B	2.00	57.51	40.49	Silty clay
19-05	Clinton	0.4-0.6	B	0.83	54.00	45.17	Silty clay
19-13	Clinton	1.7-2.1	2B	18.19	55.97	25.84	Silt loam
37-1	Coles	0.0-0.2	Ap	18.32	63.08	18.60	Silt loam
37-2	Coles	0.2-0.4	A	13.61	55.00	31.39	Silty clay loam
37-3	Coles	0.4-0.5	AB	8.37	49.39	42.24	Silty clay
37-4	Coles	1.5-0.8	Bt1	6.78	55.75	37.47	Silty clay loam
37-8	Coles	1.5-1.8	C2	46.84	32.74	20.42	Loam
37-11	Coles	2.2-2.4	Cg5	17.20	59.64	23.16	Silt loam
51-1	Coles	0.0-0.2	Ap	6.75	72.90	20.35	Silt loam
51-2	Coles	0.2-0.4	Ap2	5.40	70.00	24.60	Silt loam
51-3	Coles	0.4-0.6	BA	2.67	56.90	40.43	Silty clay
51-4	Coles	0.6-0.8	Bt	3.30	57.92	38.78	Silty clay loam
51-6	Coles	1.1-1.2	B/C	24.11	50.49	25.40	Loam
51-21	Coles	4.1-4.2	D	31.60	46.95	21.45	Loam
128-1	Cook	0.0-0.2	A1	42.98	39.11	17.91	Loam
128-2	Cook	0.2-0.3	A2	25.86	47.29	26.85	Loam
128-3	Cook	0.3-0.6	Bwcalc	93.77	5.47	0.76	Sand
128-4	Cook	0.6-0.8	Bwcalc	95.42	4.18	0.40	Sand
128-7	Cook	1.0-1.1	Ab2	78.30	16.50	5.20	Loamy sand
128-9	Cook	1.2-1.4	C2	89.24	8.20	2.56	Sand
130-1	Cook	0.0-0.2	A	4.30	60.26	35.44	Silty clay loam
130-3	Cook	0.4-0.6	B1	1.96	58.69	39.35	Silty clay loam
130-5	Cook	0.7-0.9	B2g	1.61	58.65	39.74	Silty clay loam
130-8	Cook	1.2-1.3	CBg	2.22	59.71	38.07	Silty clay loam
130-12	Cook	1.6-1.8	CD	3.48	69.04	27.48	Silty clay loam
130-13	Cook	1.8-2.0	D	2.94	68.10	28.96	Silty clay loam
35-1	Crawford	0.0-0.2	Ap	13.52	73.24	13.24	Silt loam
35-2	Crawford	0.2-0.4	E	11.00	70.60	18.40	Silt loam
35-3	Crawford	0.4-0.5	BE	6.22	63.86	29.92	Silty clay loam
35-4	Crawford	1.5-0.9	Bt1	4.96	62.24	32.80	Silty clay loam
35-6	Crawford	1.2-1.6	Bt3	6.46	76.48	17.06	Silt loam
35-9	Crawford	2.4-2.7	B6	24.50	53.81	21.69	Silt loam
126-1	DeKalb	0.0-0.3	Ap	2.27	65.59	32.14	Silty clay loam
126-2	DeKalb	0.3-0.5	A2	2.84	57.27	39.89	Silty clay loam
126-3	DeKalb	0.5-0.6	AB	3.67	57.15	39.18	Silty clay loam
126-5	DeKalb	0.8-1.0	Bg	3.23	61.05	35.72	Silty clay loam
126-7	DeKalb	1.2-1.4	Bg	4.24	64.39	31.37	Silty clay lam
126-11	DeKalb	1.8-2.0	2C	39.16	43.13	17.71	Loam
134-1	DeKalb	0.0-0.2	Ap	3.98	70.89	25.13	Silt loam
134-2	DeKalb	0.2-0.4	B1	1.63	66.67	31.70	Silty clay loam
134-3	DeKalb	0.4-0.6	B2tj	1.60	64.50	33.90	Silty clay loam
134-4	DeKalb	0.6-0.8	B3t	5.02	62.87	32.11	Silty clay loam
134-5	DeKalb	0.8-1.0	B4t	22.92	49.87	27.21	Clay loam
134-6	DeKalb	1.0-1.2	C	36.35	45.76	17.89	Loam
52-1	Douglas	0.0-0.3	Ap	7.72	61.69	30.59	Silty clay loam
52-2	Douglas	0.3-0.5	BA	6.94	59.83	33.23	Silty clay loam
52-3	Douglas	0.5-0.6	Bg	6.14	59.66	34.20	Silty clay loam
52-5	Douglas	0.9-1.0	BCtj	7.06	62.95	29.99	Silty clay loam
52-7	Douglas	1.2-1.4	C	11.98	62.19	25.83	Silt loam
52-14	Douglas	2.8-3.0	2DC	29.96	44.64	25.40	Loam
66-1	Douglas	0.0-0.3	Ap	14.22	64.94	20.84	Silt loam
66-2	Douglas	0.3-0.5	AB	8.10	52.23	39.67	Silty clay loam
66-3	Douglas	0.5-0.7	BA	10.73	51.90	37.37	Silty clay loam
66-4	Douglas	0.7-0.9	Bg	11.26	55.70	33.04	Silty clay loam
66-5	Douglas	0.9-1.1	Bg	15.56	56.94	27.50	Silty clay loam
66-6	Douglas	1.1-1.3	2C	27.64	50.02	22.34	Loam
129-01	DuPage	0.0-0.2	Bw	15.50	54.06	30.44	Silty clay loam
129-04	DuPage	0.8-1.1	C	16.33	55.01	28.66	Silty clay loam

Continued on next page

Electronic Filing: Received, Clerk's Office 3/24/2022

Sample ID	County	Depth interval (m)	Horizon	Sand (%)	Silt (%)	Clay (%)	Texture
129-05	DuPage	1.1-1.3	2Oa	5.86	61.78	32.36	Silty clay loam
129-06	DuPage	1.3-1.5	2Bg	1.08	68.22	30.70	Silty clay loam
129-07	DuPage	1.5-1.6	3Bg	13.04	62.72	24.24	Silt loam
129-11	DuPage	2.0-2.2	3C22	17.76	53.90	28.34	Silty clay loam
67-1	Edgar	0.0-0.2	Ap	25.68	49.60	24.72	Loam
67-2	Edgar	0.2-0.4	A	7.18	66.10	26.72	Silt loam
67-3	Edgar	0.4-0.6	A	4.26	69.10	26.64	Silt loam
67-5	Edgar	0.7-0.8	Bt	2.18	55.28	42.54	Silty clay
67-7	Edgar	1.0-1.2	BCt	9.34	62.70	27.96	Silty clay loam
67-9	Edgar	1.4-1.7	2C	37.60	42.76	19.64	Loam
22-01	Edwards	0.0-0.1	A	28.60	57.80	13.60	Silt loam
22-02	Edwards	0.1-0.4	A	42.22	48.10	9.68	Loam
22-03	Edwards	0.4-0.6	A	36.03	54.65	9.32	Silt loam
22-04	Edwards	0.6-0.9	A	46.76	45.00	8.24	Silt loam
22-08	Edwards	1.4-1.8	C	32.92	54.86	12.22	Silt loam
22-14	Edwards	2.9-3.1	C	71.92	14.40	13.68	Sandy loam
24-01	Edwards	0.0-0.2	A	4.56	80.44	15.00	Silt loam
24-02	Edwards	0.2-0.4	A	1.74	77.06	21.20	Silt loam
24-03	Edwards	0.4-0.5	B	1.02	69.86	29.12	Silty clay loam
24-04	Edwards	0.5-0.6	B	1.00	69.65	29.35	Silty clay loam
24-10	Edwards	1.8-2.2	C	34.26	46.22	19.52	Loam
24-16	Edwards	2.8-3.0	2B	46.70	30.66	22.64	Loam
39-1/2	Effingham	0.0-0.3	A	15.15	68.93	15.92	Silt loam
39-3	Effingham	0.3-0.4	E	5.17	59.10	35.73	Silty clay loam
39-4	Effingham	0.4-0.8	B1	3.46	57.94	38.60	Silty clay loam
39-5	Effingham	0.8-0.9	B2	4.83	65.94	29.23	Silty clay loam
39-7	Effingham	1.0-1.3	2B1	24.56	52.48	22.96	Silt loam
39-13	Effingham	2.7-2.9	3Bt4	35.88	32.41	31.71	Clay loam
30-1	Fayette	0.0-0.2	Ap	10.45	75.60	13.95	Silt loam
30-2	Fayette	0.2-0.4	AE	6.62	74.94	18.44	Silt loam
30-3	Fayette	0.4-0.5	E	4.60	70.61	24.79	Silt loam
30-4	Fayette	0.5-0.9	B1	7.08	61.52	31.40	Silty clay loam
30-8	Fayette	1.6-1.8	2B	42.00	36.76	21.24	Loam
31-1	Fayette	0.0-0.1	Ap	24.83	46.59	28.58	Clay loam
31-2	Fayette	0.1-0.4	Bt1	20.61	43.12	36.27	Clay loam
31-3	Fayette	0.4-0.7	Bt2	25.97	42.59	31.44	Clay loam
31-4	Fayette	0.7-1.1	Bt3	33.43	37.49	29.08	Clay loam
31-8	Fayette	1.1-2.0	B7	52.20	31.62	16.18	Loam
31-20	Fayette	3.8-4.9	2A	23.94	54.69	21.37	Silt loam
40-1	Fayette	0.0-0.1	Ap	15.20	70.17	14.63	Silt loam
40-2	Fayette	0.1-0.4	E	10.17	72.27	17.56	Silt loam
40-3	Fayette	0.4-0.5	B1	7.04	64.38	28.58	Silty clay loam
40-4	Fayette	0.5-0.7	B2	5.91	62.23	31.86	Silty clay loam
40-7	Fayette	1.0-1.2	2B1	5.32	59.96	34.72	Silty clay loam
40-14	Fayette	2.8-3.1	3Bt1	35.14	36.73	28.13	Clay loam
41-1	Fayette	0.0-0.3	Ap	5.13	78.19	16.68	Silt loam
41-2	Fayette	0.3-0.4	E1	4.20	74.64	21.16	Silt loam
41-3	Fayette	0.4-0.5	E2	3.48	74.46	22.06	Silt loam
41-4	Fayette	0.5-0.7	EB	4.97	63.58	31.45	Silty clay loam
41-9	Fayette	1.8-2.4	C1	23.47	61.17	15.36	Silt loam
41-23	Fayette	5.2-5.5	3C2	30.25	47.01	22.74	Loam
89-1	Ford	0.0-0.3	Ap	11.72	60.61	27.67	Silty clay loam
89-2	Ford	0.3-0.5	Bg1	6.15	62.54	31.31	Silty clay loam
89-3	Ford	0.5-0.6	Bgt21	3.61	53.65	42.74	Silty clay
89-4	Ford	0.6-0.9	Bgt22	3.78	59.06	37.16	Silty clay loam
89-5	Ford	0.9-1.0	2Bg3	59.87	27.69	12.44	Sandy loam
89-7	Ford	1.1-1.3	2C	76.01	16.15	7.84	Sandy loam
11-1	Franklin	0.0-0.2	Ap	7.06	75.58	17.36	Silt loam
11-2	Franklin	0.2-0.4	AE	5.41	77.87	16.72	Silt loam

Continued on next page



Electronic Filing: Received, Clerk's Office 3/24/2022

Sample ID	County	Depth interval (m)	Horizon	Sand (%)	Silt (%)	Clay (%)	Texture
11-3	Franklin	0.4–0.6	AE	7.38	79.10	13.52	Silt loam
11-5	Franklin	0.9–1.1	B	14.10	71.40	14.50	Silt loam
11-8	Franklin	1.6–1.7	B	19.04	65.40	15.56	Silt loam
11-34	Franklin	6.8–6.9	C	27.36	56.07	16.57	Silt loam
79-1	Fulton	0.0–0.2	Ap	2.14	82.36	15.50	Silt loam
79-2	Fulton	0.2–0.3	E	1.94	78.62	19.44	Silt loam
79-3	Fulton	0.3–0.4	BE	1.78	67.38	30.84	Silty clay loam
79-4	Fulton	0.4–0.6	Bt	0.84	70.53	28.63	Silty clay loam
79-6	Fulton	0.8–1.1	Bt2	0.64	68.44	30.92	Silty clay loam
79-11	Fulton	1.6–1.8	C	0.69	81.16	18.16	Silt loam
84-1	Fulton	0.0–0.2	Ap	6.42	70.80	22.78	Silt loam
84-2	Fulton	0.2–0.4	Btj	4.67	63.33	32.00	Silty clay loam
84-3	Fulton	0.4–0.6	Bt	8.46	61.19	30.35	Silty clay loam
84-5	Fulton	0.8–1.0	Bt	7.49	65.61	26.90	Silty clay loam
84-9	Fulton	1.4–1.7	2Bw	83.94	5.82	10.24	Loamy sand
84-14	Fulton	2.3–2.4	2C	67.03	21.37	11.60	Sandy loam
85-1	Fulton	0.0–0.1	Ap	2.69	76.08	21.23	Silt loam
85-2	Fulton	0.1–0.4	Bt	1.13	69.64	29.23	Silty clay loam
85-3	Fulton	0.4–0.6	Bt	0.82	67.03	32.15	Silty clay loam
85-5	Fulton	0.8–1.0	Bt	0.85	67.92	31.23	Silty clay loam
85-9	Fulton	1.7–1.9	CBt	2.85	73.84	23.31	Silt loam
85-13	Fulton	2.3–2.5	C	1.54	81.98	16.48	Silt loam
46-1	Greene	0.0–0.2	Ap	0.38	80.74	18.88	Silt loam
46-2	Greene	0.2–0.4	A	0.41	79.79	19.80	Silt loam
46-4	Greene	0.6–0.7	AB	0.86	71.70	27.44	Silty clay loam
46-5	Greene	0.7–0.9	B/Ab	0.56	65.56	33.88	Silty clay loam
46-8	Greene	1.2–1.5	Bg	1.12	69.08	29.80	Silty clay loam
46-33	Greene	5.7–5.9	2DC	45.10	36.22	18.68	Loam
103-1	Grundy	0.0–0.2	Ap	18.89	49.76	31.35	Silty clay loam
103-2	Grundy	0.2–0.5	A	17.37	50.62	32.01	Silty clay loam
103-3	Grundy	0.5–0.6	BA	18.94	50.85	30.21	Silty clay loam
103-4	Grundy	0.6–0.7	Btj	49.31	35.95	14.74	Loam
103-5	Grundy	0.7–0.9	Ctj	21.78	50.48	27.74	Clay loam
12-1	Hamilton	0.1–0.2	Ap	4.74	62.51	32.75	Silty clay loam
12-2	Hamilton	0.2–0.4	B	3.87	57.46	38.67	Silty clay loam
12-4	Hamilton	0.4–0.6	B	3.90	58.24	37.86	Silty clay loam
12-6	Hamilton	0.9–1.0	B	3.18	57.42	39.40	Silty clay loam
12-19	Hamilton	2.8–3.1	2B	5.64	69.60	24.76	Silt loam
12-27	Hamilton	6.7–6.9	3C	21.73	46.65	31.62	Clay loam
81-1	Hancock	0.0–0.2	A	8.71	68.66	22.63	Silt loam
81-2	Hancock	0.2–0.6	AB	4.10	69.04	26.86	Silt loam
81-3	Hancock	0.6–0.7	Bt	3.81	57.48	38.71	Silty clay loam
81-5	Hancock	0.9–1.1	Btg	16.90	43.26	39.84	Silty clay loam
81-7	Hancock	1.3–1.5	Btg	18.23	39.02	42.75	Clay
81-13	Hancock	2.2–2.4	Btox	29.14	39.23	31.63	Clay loam
82-1	Hancock	0.0–0.2	A	1.98	74.63	23.39	Silt loam
82-2	Hancock	0.2–0.4	AB	0.66	67.49	31.85	Silty clay loam
82-3	Hancock	0.4–0.6	Bt	1.48	77.04	21.48	Silt loam
82-4	Hancock	0.6–1.0	Bt	0.97	66.57	32.46	Silty clay loam
82-9	Hancock	1.7–1.9	CBgt	1.10	72.81	26.09	Silt loam
82-13	Hancock	2.4–2.7	Cgtj	0.90	80.38	18.72	Silt loam
107-1	Henry	0.0–0.2	Ap	0.51	69.51	29.98	Silty clay loam
107-2	Henry	0.2–0.3	Bt1	0.40	72.64	26.96	Silt loam
107-3	Henry	0.3–0.6	Bt2	0.70	75.26	24.04	Silt loam
107-4	Henry	0.6–0.7	Bt3	0.60	77.87	21.53	Silt loam
107-6	Henry	0.8–0.9	2Ab	7.83	71.57	20.60	Silt loam
107-9	Henry	1.2–1.4	3BtA	21.82	39.88	38.30	Clay loam
108-1	Henry	0.0–0.2	Ap	1.11	66.09	32.80	Silty clay loam
108-2	Henry	0.2–0.4	A2	1.28	63.48	35.24	Silty clay loam

Continued on next page

## Electronic Filing: Received, Clerk's Office 3/24/2022

Sample ID	County	Depth interval (m)	Horizon	Sand (%)	Silt (%)	Clay (%)	Texture
108-3	Henry	0.4-0.6	Bt	1.49	62.42	36.09	Silty clay loam
108-5	Henry	0.8-1.0	Bt	0.86	66.28	32.86	Silty clay loam
108-7	Henry	1.2-1.4	BCtj	0.90	74.65	24.45	Silt loam
108-10	Henry	1.8-2.0	C21	0.52	81.34	18.14	Silt loam
110-1	Henry	0.0-0.2	Ap	56.38	30.36	13.26	Sandy loam
110-2	Henry	0.2-0.3	Btj	23.90	56.40	19.70	Sandy loam
110-3	Henry	0.3-0.5	Bt	56.65	22.85	20.50	Sandy clay loam
110-5	Henry	0.7-0.8	Bt	78.62	7.39	13.99	Sandy loam
110-7	Henry	0.9-1.0	E	87.71	8.07	4.22	Sand
110-9	Henry	1.2-1.4	C	95.68	3.18	1.14	Sand
111-1	Henry	0.0-0.3	Ap	41.14	35.90	22.96	Loam
111-2	Henry	0.3-0.4	A12	41.95	35.91	22.14	Loam
111-3	Henry	0.4-0.6	A13	46.84	32.90	20.26	Loam
111-4	Henry	0.6-0.8	BA	39.93	37.41	22.66	Loam
111-5	Henry	0.8-1.0	AB	56.68	27.82	15.50	Sandy loam
111-6	Henry	1.0-1.1	C1	87.77	7.25	4.98	Sand
100-1	Iroquois	0.0-0.2	Ap	24.77	53.84	21.39	Silt loam
100-2	Iroquois	0.2-0.3	BAt	17.39	51.01	31.60	Silty clay loam
100-3	Iroquois	0.3-0.6	Bt	11.24	58.10	30.66	Silty clay loam
100-5	Iroquois	0.6-0.7	B3t	10.83	70.74	18.43	Silt loam
100-6	Iroquois	0.6-1.0	C	11.00	72.82	16.18	Silt loam
100-8	Iroquois	1.3-1.5	C	5.62	80.54	13.84	Silt loam
101-1	Iroquois	0.0-0.2	Ap	7.02	55.87	37.11	Silty clay loam
101-2	Iroquois	0.2-0.4	BA	3.28	46.00	50.72	Silty clay
101-3	Iroquois	0.4-0.6	Bgtj	2.88	41.08	56.04	Silty clay
101-4	Iroquois	0.6-0.8	Bgt	5.57	37.58	56.85	Clay
101-5	Iroquois	0.8-1.1	Cgtj	3.64	45.08	51.28	Silty clay
101-7	Iroquois	1.3-1.5	Cg	5.17	44.32	50.51	Silty clay
97-1	Iroquois	0.0-0.2	Ap	20.61	50.11	29.28	Clay loam
97-2	Iroquois	0.2-0.4	A2	20.46	49.45	30.09	Clay loam
97-3	Iroquois	0.4-0.6	Bg	19.62	47.86	32.52	Clay loam
97-5	Iroquois	0.8-1.0	Bg	20.75	49.81	29.44	Silty clay loam
97-7	Iroquois	1.2-1.4	C	4.55	60.83	34.62	Clay loam
97-9	Iroquois	1.8-2.0	C	2.29	67.22	30.49	Silty clay loam
99-1	Iroquois	0.0-0.3	Ap	74.76	17.96	7.28	Sandy loam
99-2	Iroquois	0.3-0.4	BA	76.99	16.54	6.47	Loamy sand
99-3	Iroquois	0.4-0.6	Bw	80.93	11.79	7.28	Loamy sand
99-6	Iroquois	0.9-1.1	Bg	88.36	1.54	10.10	Loamy sand
99-8	Iroquois	1.3-1.5	CBg	65.22	31.28	3.50	Sand
99-9	Iroquois	1.5-1.7	Cg	65.58	31.36	3.06	Sand
8-1	Jackson	0.0-0.3	B	24.07	55.77	20.16	Silt loam
8-2	Jackson	0.3-0.4	C	10.94	72.78	16.28	Silt loam
8-3	Jackson	0.4-0.5	C	11.40	71.52	17.08	Silt loam
8-6	Jackson	1.0-1.2	2B	2.41	86.45	11.14	Silt loam
8-12	Jackson	2.4-2.7	3A	33.81	48.27	17.92	Silt loam
8-22	Jackson	4.1-4.2	4C	1.70	79.32	18.98	Silt loam
38-1	Jasper	0.0-0.2	Ap	12.79	70.55	16.48	Silt loam
38-2	Jasper	0.2-0.4	AE	12.84	69.44	17.72	Silt loam
38-3	Jasper	0.4-0.6	E	11.89	70.87	17.24	Silt loam
38-5	Jasper	0.6-0.9	Bt1	2.84	49.14	48.02	Silty clay
38-8	Jasper	1.5-1.9	2A1	29.88	44.58	25.54	Loam
38-13	Jasper	3.7-3.8	2Bt4	39.56	29.24	31.20	Clay loam
26-01	Jefferson	0.0-0.2	A	11.72	76.40	11.88	Silt loam
26-02	Jefferson	0.2-0.5	A	18.70	66.86	14.44	Silt loam
26-03	Jefferson	0.5-0.6	E	19.90	63.96	16.14	Silt loam
26-04	Jefferson	0.6-0.9	B	28.60	57.78	13.62	Silt loam
26-08	Jefferson	1.5-1.7	2C	19.82	45.20	34.98	Silty clay loam
26-15	Jefferson	2.4-2.8	2D	2.38	73.60	24.02	Silt loam
44-1	Jersey	0.0-0.3	Ap	3.74	85.94	10.32	Silt

*Continued on next page*



Electronic Filing: Received, Clerk's Office 3/24/2022

Sample ID	County	Depth interval (m)	Horizon	Sand (%)	Silt (%)	Clay (%)	Texture
44-2	Jersey	0.3-0.5	EB	3.27	77.58	19.15	Silt loam
44-3	Jersey	0.5-0.6	B	1.94	62.21	35.85	Silty clay loam
44-4	Jersey	0.6-0.9	Btj	2.20	64.45	33.35	Silty clay loam
44-13	Jersey	2.4-2.7	2Ab	11.77	63.51	24.72	Silt loam
44-29	Jersey	5.4-5.5	2C	37.38	45.36	17.26	Loam
119-1	Jo Daviess	0.0-0.2	Ap	5.19	78.47	16.34	Silt loam
119-2	Jo Daviess	0.2-0.4	Ap	2.72	77.18	20.15	Silt loam
119-3	Jo Daviess	0.4-0.6	BA	3.13	72.23	24.64	Silt loam
119-5	Jo Daviess	0.7-0.9	Bt	1.55	69.43	29.02	Silty clay loam
119-6	Jo Daviess	0.9-1.0	Bt	0.53	74.59	24.85	Silt loam
119-11	Jo Daviess	1.6-1.9	2Cr	2.32	43.18	54.50	Silty clay
120-1	Jo Daviess	0.0-0.1	Ap	3.69	69.81	26.50	Silt loam
120-2	Jo Daviess	0.1-0.3	Bt	2.13	68.16	29.71	Silty clay loam
120-4	Jo Daviess	0.4-0.6	Bt	0.86	65.94	33.20	Silty clay loam
120-5	Jo Daviess	0.6-0.8	Btg	1.22	65.53	33.25	Silty clay loam
120-8	Jo Daviess	0.9-1.0	C	0.62	72.93	26.45	Silt loam
120-15	Jo Daviess	1.4-1.6	2Ab	1.46	64.87	33.67	Silty clay loam
3-1	Johnson	0.0-0.2	Ap	4.65	80.43	14.92	Silt loam
3-2	Johnson	0.2-0.4	B	3.13	77.83	19.04	Silt loam
3-3	Johnson	0.4-0.6	B	5.99	75.92	18.09	Silt loam
3-4	Johnson	0.6-0.9	B	5.18	71.38	23.44	Silt loam
3-5	Johnson	0.9-1.3	B	1.51	67.26	31.23	Silty clay loam
3-10	Johnson	2.0-2.2	B	2.82	74.96	22.22	Silt loam
3-14	Johnson	3.0-3.6	B	1.18	24.75	74.07	Clay
133-1	Kane	0.0-0.3	Ap	15.20	66.89	17.91	Silt loam
133-2	Kane	0.3-0.5	Btj	18.06	54.81	27.13	Silty clay loam
133-3	Kane	0.5-0.6	2Bt	25.24	49.91	24.85	Loam
133-4	Kane	0.6-0.7	2BC	34.71	44.67	20.62	Loam
133-5	Kane	0.8-1.0	2C1	32.52	55.04	12.44	Silt loam
133-6	Kane	1.0-1.2	2C2	37.60	53.23	9.17	Silt loam
135-1	Kane	0.0-0.3	Ap	4.11	67.12	28.77	Silty clay loam
135-2	Kane	0.3-0.5	Btj	14.56	47.48	37.96	Silty clay loam
135-3	Kane	0.5-0.6	Btj	37.34	28.29	34.37	Clay loam
135-4	Kane	0.6-0.7	2Bt	20.20	35.63	44.17	Clay
135-5	Kane	0.7-0.9	2CB	20.29	52.83	26.88	Silt loam
135-6	Kane	0.9-1.2	2C	25.20	55.34	19.46	Silt loam
102-1	Kankakee	0.0-0.2	A	43.17	41.97	14.86	Loam
102-2	Kankakee	0.2-0.4	E	52.36	34.36	13.28	Silt loam
102-3	Kankakee	0.4-0.6	Bt	52.12	28.36	19.54	Silt loam
102-4	Kankakee	0.6-0.7	Bt	50.14	21.94	27.92	Silty clay loam
102-5	Kankakee	0.7-0.9	Btfr	43.60	23.17	33.23	Clay loam
102-6	Kankakee	0.9-1.1	Cr	63.24	27.12	9.64	Silt loam
98-1	Kankakee	0.0-0.2	Ap	30.33	49.68	19.99	Loam
98-2	Kankakee	0.2-0.5	Bt	44.66	30.41	24.93	Loam
98-3	Kankakee	0.5-0.6	Ab	43.59	36.92	19.49	Loam
98-5	Kankakee	0.6-0.8	Bt	54.68	20.48	24.84	Sandy clay loam
98-6	Kankakee	0.8-1.0	Bt	56.55	20.40	23.05	Sandy clay loam
98-7	Kankakee	1.0-1.2	Cr	32.26	57.70	10.04	Silt loam
136-1	Kendall	0.0-0.2	Ap1	3.84	69.10	27.06	Silty clay loam
136-4	Kendall	0.5-0.6	Btj	1.43	64.31	34.26	Silty clay loam
136-6	Kendall	0.8-0.9	Btj	6.28	61.43	32.29	Silty clay loam
136-8	Kendall	1.1-1.4	2Bt	51.67	23.53	24.80	Sandy clay loam
136-9	Kendall	1.4-1.5	2C1	44.82	38.92	16.26	Loam
136-10	Kendall	1.5-1.7	2C2	36.00	47.09	16.91	Loam
91-1	Knox	0.0-0.2	Ap1	0.57	73.22	26.20	Silt loam
91-2	Knox	0.2-0.4	Ap2	0.55	71.64	27.81	Silty clay loam
91-3	Knox	0.4-0.6	BA	1.22	68.32	30.46	Silty clay loam
91-5	Knox	0.8-1.0	Btj	1.37	32.76	65.87	Silty clay loam
91-7	Knox	1.1-1.3	CBtj	1.32	72.79	25.90	Silt loam

Continued on next page

## Electronic Filing: Received, Clerk's Office 3/24/2022

Sample ID	County	Depth interval (m)	Horizon	Sand (%)	Silt (%)	Clay (%)	Texture
91-11	Knox	1.9-2.1	C	0.34	79.60	20.06	Silt loam
131-1	Lake	0.0-0.1	A+C1	18.31	47.95	33.74	Silty clay loam
131-3	Lake	0.3-0.5	C3	15.72	36.12	48.16	Clay
131-4	Lake	0.5-0.6	2CB	3.31	53.85	42.84	Silty clay
131-5	Lake	0.6-0.8	2C	3.33	51.31	45.36	Silty clay
131-6	Lake	0.8-1.0	2C	2.56	51.18	46.26	Silty clay
131-7	Lake	1.0-1.2	2C	0.94	52.74	46.32	Silty clay
104-1	LaSalle	0.0-0.3	Ap	3.18	68.82	28.00	Silty clay loam
104-2	LaSalle	0.3-0.5	AB	2.45	67.50	30.05	Silty clay loam
104-3	LaSalle	0.5-0.6	Bt	1.18	62.70	36.12	Silty clay loam
104-4	LaSalle	0.6-0.8	Bt	1.22	64.22	34.56	Silty clay loam
104-6	LaSalle	0.9-1.1	C	1.47	78.33	20.20	Silt loam
104-8	LaSalle	1.2-1.5	C	2.32	77.08	20.60	Silt loam
114-1	LaSalle	0.0-0.2	Ap	2.72	69.45	27.83	Silty clay loam
114-2	LaSalle	0.2-0.4	A2	1.62	64.71	33.67	Silty clay loam
114-3	LaSalle	0.4-0.6	Bt	1.40	63.62	34.98	Silty clay loam
114-4	LaSalle	0.6-0.8	Bt	1.70	67.16	31.14	Silty clay loam
114-5	LaSalle	0.8-1.0	Btj	1.69	73.18	25.33	Silt loam
114-6	LaSalle	1.0-1.2	Ctj	2.88	78.42	18.70	Silt loam
34-1	Lawrence	0.0-0.2	Ap	5.45	79.23	15.32	Silt loam
34-2	Lawrence	0.2-0.3	A2	4.99	80.01	15.00	Silt loam
34-3	Lawrence	0.3-0.4	E	4.92	78.62	16.46	Silt loam
34-4	Lawrence	0.4-0.5	B1	2.60	74.85	22.55	Silt loam
34-10	Lawrence	1.2-1.5	2Btx4	28.12	56.42	15.46	Silty clay
34-13	Lawrence	1.8-2.0	3A	45.43	39.69	14.88	Loam
115-1	Lee	0.0-0.3	Ap	8.70	66.06	25.24	Silt loam
115-2	Lee	0.3-0.6	AB	7.28	65.50	27.22	Silty clay loam
115-3	Lee	0.6-0.7	BAG	8.20	65.64	26.16	Silt loam
115-5	Lee	0.9-1.1	Cg	7.10	66.56	26.34	Silt loam
115-7	Lee	1.2-1.4	Cg	5.60	77.38	17.02	Silt loam
115-9	Lee	1.5-1.7	Cg	30.92	56.48	12.60	Silt loam
116-1	Lee	0.0-0.2	Ap	39.96	44.14	15.90	Loam
116-3	Lee	0.3-0.5	Btj	37.98	43.98	18.04	Loam
116-4	Lee	0.5-0.6	Btj	42.82	38.44	18.74	Loam
116-5	Lee	0.6-0.8	Btj	58.44	26.96	14.60	Sandy loam
116-6	Lee	0.8-0.9	BC	77.63	13.64	8.73	Sandy loam
116-9	Lee	1.1-1.3	C	91.66	4.08	4.26	Sand
95-1	Livingston	0.0-0.3	Ap	18.25	55.48	26.27	Silt loam
95-2	Livingston	0.3-0.5	A	16.66	55.59	27.75	Silty clay loam
95-3	Livingston	0.5-0.6	Bgtj	11.56	52.14	36.30	Silty clay loam
95-5	Livingston	0.8-0.9	Bgt2	6.70	58.18	35.12	Silty clay loam
95-8	Livingston	1.2-1.4	2Cgt1	21.74	55.90	22.36	Silt loam
95-13	Livingston	2.0-2.3	3Cg	11.44	50.54	38.02	Silty clay loam
96-1	Livingston	0.0-0.3	Ap	7.70	52.57	39.73	Silty clay loam
96-2	Livingston	0.3-0.5	Bgt	17.07	41.25	41.68	Silty clay
96-3	Livingston	0.5-0.6	2CBtj	28.29	45.77	25.94	Loam
96-4	Livingston	0.6-0.9	2CBtj	22.10	49.58	28.32	Clay loam
96-7	Livingston	1.1-1.4	2C	8.14	53.49	38.37	Silty clay loam
96-11	Livingston	2.0-2.3	4C	10.98	50.10	38.92	Silty clay loam
64-1	Logan	0.0-0.2	Ap	0.64	72.44	26.92	Silt loam
64-2	Logan	0.2-0.5	A	0.38	70.70	28.92	Silty clay loam
64-3	Logan	0.5-0.6	Bt1	0.71	73.31	25.98	Silt loam
64-6	Logan	1.0-1.1	BC	0.64	78.90	20.46	Silt loam
64-8	Logan	1.2-1.5	C	1.04	84.08	14.88	Silt loam
64-22	Logan	4.1-4.3	3BAAb	24.60	43.68	31.72	Clay loam
74-1	Logan	0.0-0.2	Ap	1.28	68.00	30.72	Silty clay loam
74-3	Logan	0.3-0.5	AB	1.62	66.02	32.36	Silty clay loam
74-4	Logan	0.5-0.7	Bg	1.24	66.37	32.39	Silty clay loam
74-5	Logan	0.7-0.9	B	2.46	65.58	31.96	Silty clay loam

*Continued on next page*

Electronic Filing: Received, Clerk's Office 3/24/2022

Sample ID	County	Depth interval (m)	Horizon	Sand (%)	Silt (%)	Clay (%)	Texture
74-7	Logan	1.0–1.2	Bgtj	1.20	67.90	30.90	Silty clay loam
74-11	Logan	1.7–1.8	C	4.10	85.24	10.66	Silt
77-1	Logan	0.0–0.3	Ap	1.98	75.07	22.95	Silt loam
77-2	Logan	0.3–0.5	AB	1.78	67.98	30.24	Silty clay loam
77-5	Logan	0.5–1.0	Bt	1.42	70.94	27.64	Silty clay loam
77-8	Logan	1.3–1.5	Bt1	2.10	76.66	21.20	Silt loam
77-14	Logan	2.2–2.4	C	88.14	7.77	4.10	Loamy sand
77-26	Logan	3.9–4.1	Ab	1.85	82.57	15.58	Silt loam
75-1	Macon	0.0–0.2	Ap	3.14	71.82	25.04	Silt loam
75-2	Macon	0.2–0.4	AB	2.10	63.22	34.68	Silty clay loam
75-3	Macon	0.4–0.6	Btj	1.80	59.51	38.69	Silty clay loam
75-4	Macon	0.6–0.8	Bt	2.50	63.06	34.44	Silty clay loam
75-6	Macon	1.0–1.1	Btj	9.12	65.98	24.90	Silt loam
75-10	Macon	1.6–1.8	2C	39.97	37.73	22.30	Loam
43-1	Macoupin	0.0–0.2	Ap	4.24	85.80	9.96	Silt
43-3	Macoupin	0.3–0.5	E	5.66	73.78	20.56	Silt loam
43-5	Macoupin	0.6–0.9	Bt	2.90	59.65	37.45	Silty clay loam
43-8	Macoupin	1.3–1.5	C	0.64	81.38	17.98	Silt loam
43-12	Macoupin	1.9–2.1	3A	20.78	51.04	28.18	Clay loam
43-27	Macoupin	4.9–5.1	3CD	42.74	40.30	16.96	Loam
47-1	Macoupin	0.0–0.2	Ap	17.27	69.01	13.72	Silt loam
47-2	Macoupin	0.2–0.6	C1	12.32	72.20	15.48	Silt loam
47-4	Macoupin	0.7–1.1	C3	37.51	49.31	13.18	Loam
47-5	Macoupin	1.1–1.2	C4	14.70	70.18	15.12	Silt loam
47-8	Macoupin	1.8–2.0	2Bt1	32.52	50.50	16.98	Silt loam
47-16	Macoupin	4.3–4.5	2C7	39.36	40.66	19.98	Loam
28-1	Madison	0.0–0.3	A	16.58	68.67	14.75	Silt loam
28-2	Madison	0.3–0.7	B1	2.01	68.12	29.87	Silty clay loam
28-3	Madison	0.7–1.1	B2	4.12	75.70	20.18	Silt loam
28-4	Madison	1.1–1.4	B3	5.04	71.07	23.84	Silt loam
28-10	Madison	2.9–3.1	C3	21.02	64.79	14.19	Silt loam
28-15	Madison	4.9–5.1	D3	18.20	67.72	14.08	Silt loam
20-1	Marion	0.0–0.1	A	12.39	72.69	14.92	Silt loam
20-2	Marion	0.1–0.2	E	7.33	77.39	15.28	Silt loam
20-3	Marion	0.2–0.4	B	2.93	62.95	34.12	Silty clay loam
20-4	Marion	0.4–0.6	B	1.52	54.76	43.72	Silty clay
20-8	Marion	1.3–1.7	B	22.16	56.08	21.76	Silt loam
20-11	Marion	2.3–2.4	C	25.66	55.48	18.86	Silt loam
78-1	Mason	0.0–0.3	Ap	81.72	14.52	3.76	Loamy sand
78-3	Mason	0.4–0.6	Bt1	16.21	53.27	30.52	Silty clay loam
78-4	Mason	0.6–0.7	Bt1	48.64	26.36	25.00	Sandy clay loam
78-9	Mason	1.3–1.4	C	95.12	1.02	3.86	Sand
78-12	Mason	1.6–1.8	â	91.14	2.24	6.62	Sand
78-17	Mason	2.7–2.9	C	96.04	2.86	1.10	Sand
80-1	McDonough	0.0–0.2	Ap	42.01	44.04	13.95	Loam
80-4	McDonough	0.3–0.4	C/A	29.82	53.22	16.96	Silt loam
80-8	McDonough	0.8–0.9	CB	47.25	36.70	16.06	Loam
80-10	McDonough	1.1–1.2	2CB	16.04	63.55	20.42	Silt loam
80-15	McDonough	1.5–1.6	4B	15.64	63.89	20.47	Silt loam
80-20	McDonough	2.2–2.4	5Ab	26.64	48.84	24.52	Loam
83-1	McDonough	0.0–0.2	A	1.08	68.13	30.79	Silty clay loam
83-2	McDonough	0.2–0.4	A	1.26	65.62	33.12	Silty clay loam
83-4	McDonough	0.8–1.0	Bgt	1.64	62.50	35.86	Silty clay loam
83-5	McDonough	1.0–1.2	Bgt	0.58	67.14	32.28	Silty clay loam
83-10	McDonough	2.0–2.1	BCtj	0.84	79.73	19.43	Silt loam
83-14	McDonough	2.6–2.8	2Ab	12.27	59.83	27.90	Silty clay loam
132-1	McHenry	0.0–0.2	Ap	12.05	63.16	24.79	Silt loam
132-2	McHenry	0.2–0.4	Btj	22.04	47.86	30.10	Clay loam
132-3	McHenry	0.4–0.6	Btj	4.74	60.35	34.91	Silty clay loam

Continued on next page

## Electronic Filing: Received, Clerk's Office 3/24/2022

Sample ID	County	Depth interval (m)	Horizon	Sand (%)	Silt (%)	Clay (%)	Texture
132-4	McHenry	0.6–0.7	2Bt	42.69	30.24	27.07	Clay loam
132-5	McHenry	0.7–0.9	2BC	40.79	45.13	14.08	Loam
132-6	McHenry	0.9–1.0	2C1	14.30	78.36	7.34	Silt loam
72-1	McLean	0.0–0.3	Ap	3.30	67.67	29.03	Silty clay loam
72-2	McLean	0.3–0.5	AB	4.08	60.56	35.36	Silty clay loam
72-3	McLean	0.5–0.6	Bg	2.60	60.63	36.77	Silty clay loam
72-4	McLean	0.6–0.9	Bg	3.24	63.50	33.26	Silty clay loam
72-6	McLean	1.0–1.2	Bg	7.26	63.36	29.38	Silty clay loam
72-9	McLean	1.7–2.0	2C	35.36	40.74	23.90	Loam
73-1	McLean	0.0–0.2	Ap	2.82	72.47	24.71	Silt loam
73-2	McLean	0.2–0.4	AB	1.47	65.22	33.31	Silty clay loam
73-3	McLean	0.4–0.6	Bt	1.34	64.14	34.13	Silty clay loam
73-4	McLean	0.6–0.9	Btj	1.29	68.81	29.90	Silty clay loam
73-5	McLean	0.9–1.0	Btj	1.17	72.89	25.94	Silt loam
73-6	McLean	1.0–1.2	C	1.08	78.10	20.82	Silt loam
88-1	McLean	0.0–0.2	Ap1	9.27	63.29	27.44	Silty clay loam
88-2	McLean	0.2–0.4	Ap2	3.74	64.44	31.82	Silty clay loam
88-3	McLean	0.4–0.6	Btj	1.82	63.42	34.76	Silty clay loam
88-5	McLean	0.8–0.9	Bt	7.54	58.54	33.92	Silty clay loam
88-7	McLean	1.1–1.2	2BC	34.10	28.09	37.81	Clay loam
88-8	McLean	1.2–1.4	2CBt	44.04	39.98	15.98	Loam
53-1	Menard	0.0–0.2	Ap	4.15	69.05	26.80	Silt loam
53-2	Menard	0.2–0.4	AB	2.94	65.71	31.35	Silty clay loam
53-3	Menard	0.4–0.6	BAt	1.50	58.35	40.15	Silty clay loam
53-4	Menard	0.6–0.8	Bt	2.10	68.27	29.63	Silty clay loam
53-5	Menard	0.8–1.0	CB	0.92	74.91	24.18	Silt loam
53-11	Menard	2.3–2.4	3C	38.90	37.82	23.28	Loam
63-1	Menard	0.0–0.2	Ap	2.59	80.46	16.95	Silt loam
63-2	Menard	0.2–0.4	Ap2	2.58	82.14	15.28	Silt loam
63-3	Menard	0.4–0.6	A	3.78	80.78	15.44	Silt loam
63-6	Menard	1.0–1.3	2Ab	12.30	70.94	16.76	Silt loam
63-15	Menard	2.7–2.9	2Bwg	16.64	65.66	17.70	Silt loam
109-1	Mercer	0.0–0.2	Ap	7.87	65.74	26.39	Silt loam
109-3	Mercer	0.4–0.6	A11	2.61	74.69	22.70	Silt loam
109-4	Mercer	0.6–0.9	A12	4.74	79.24	16.02	Silt loam
109-5	Mercer	0.6–1.1	Btj	17.16	56.73	26.11	Silt loam
109-7	Mercer	1.2–1.4	Bk	32.14	43.23	24.63	Loam
109-9	Mercer	1.6–1.8	2C2	37.26	41.34	21.40	Loam
16-01	Monroe	0.0–0.1	A	1.16	68.01	30.83	Silty clay loam
16-02	Monroe	0.1–0.3	E	1.25	60.11	38.64	Silty clay loam
16-03	Monroe	0.3–0.6	B	2.27	53.79	43.94	Silty clay
16-04	Monroe	0.6–0.9	B	0.96	66.16	32.88	Silty clay loam
16-16	Monroe	2.8–3.0	2A	13.46	54.64	31.90	Silty clay loam
16-26	Monroe	5.6–5.8	2B	31.64	52.73	15.63	Silt loam
17-01	Monroe	0.0–0.2	A	16.04	48.65	35.31	Silty clay loam
17-02	Monroe	0.2–0.3	A	14.69	48.21	37.10	Silty clay loam
17-03	Monroe	0.3–0.5	A	16.55	44.63	38.82	Silty clay loam
17-04	Monroe	0.5–0.6	A	24.54	38.75	36.71	Clay loam
17-16	Monroe	2.4–3.1	C	54.04	32.74	13.22	Loam
42-1	Montgomery	0.0–0.2	Ap	36.14	52.02	11.84	Silt loam
42-2	Montgomery	0.2–0.4	A	35.56	48.88	15.56	Loam
42-4	Montgomery	0.6–0.8	AB	39.72	43.02	17.26	Loam
42-6	Montgomery	1.0–1.2	Bw	56.45	30.47	13.08	Sandy loam
42-16	Montgomery	2.8–3.1	CA	76.70	13.20	10.10	Loamy sand
42-23	Montgomery	4.3–4.6	D/A	11.17	66.63	22.20	Silt loam
48-1	Montgomery	0.0–0.2	Ap	3.74	77.34	18.92	Silt loam
48-3	Montgomery	0.3–0.5	Bt1	3.20	69.64	27.16	Silty clay loam
48-4	Montgomery	0.5–0.6	Bt2	2.66	59.38	37.96	Silty clay loam
48-6	Montgomery	0.8–1.0	Bt4	2.48	61.10	36.42	Silty clay loam

*Continued on next page*

## Electronic Filing: Received, Clerk's Office 3/24/2022

Sample ID	County	Depth interval (m)	Horizon	Sand (%)	Silt (%)	Clay (%)	Texture
48-9	Montgomery	1.3-1.6	C	2.51	72.27	25.22	Silt loam
48-16	Montgomery	3.1-3.4	2C1	43.16	37.82	19.02	Loam
57-1	Morgan	0.0-0.2	Ap	1.51	82.37	16.12	Silt loam
57-2	Morgan	0.2-0.4	AE	0.40	69.77	29.83	Silty clay loam
57-3	Morgan	0.4-0.6	Btj	0.42	66.16	33.42	Silty clay loam
57-5	Morgan	0.8-1.0	Bt	0.52	70.94	28.54	Silty clay loam
57-11	Morgan	2.0-2.3	CB	0.64	84.08	15.28	Silt loam
57-16	Morgan	3.2-3.4	2A	2.29	82.77	14.94	Silt loam
122-1	Ogle	0.0-0.2	Ap	14.66	59.76	25.58	Silt loam
122-2	Ogle	0.2-0.4	AB	3.69	66.38	29.93	Silty clay loam
122-3	Ogle	0.4-0.6	Btj	2.40	70.52	27.08	Silty clay loam
122-5	Ogle	0.9-1.0	Btj	1.84	67.08	31.08	Silty clay loam
122-8	Ogle	1.5-1.8	Bt	1.00	74.47	24.53	Silt loam
122-9	Ogle	1.7-2.0	C	1.42	82.16	16.42	Silt loam
123-1	Ogle	0.0-0.2	Ap	2.93	72.11	24.96	Silt loam
123-2	Ogle	0.2-0.4	AB	1.25	65.06	33.69	Silty clay loam
123-3	Ogle	0.4-0.6	Btj	2.68	65.96	31.36	Silty clay loam
123-4	Ogle	0.6-0.8	E'	1.84	73.98	24.18	Silt loam
123-7	Ogle	0.9-1.1	2Bg	2.85	47.67	49.48	Silty clay
123-8	Ogle	1.1-1.3	3AB	14.66	39.64	45.70	Clay
92-1	Peoria	0.0-0.2	Ap	1.95	68.66	29.39	Silty clay loam
92-2	Peoria	0.2-0.3	AB	0.31	65.39	34.30	Silty clay loam
92-3	Peoria	0.3-0.5	BA	0.57	65.73	33.70	Silty clay loam
92-4	Peoria	0.5-0.6	Bt	0.52	69.65	29.83	Silty clay loam
92-6	Peoria	1.1-1.2	BCtj	0.20	77.33	22.47	Silt loam
92-9	Peoria	1.6-1.7	C	0.22	82.88	17.50	Silt loam
93-1	Peoria	0.0-0.2	A/E	0.99	81.15	17.86	Silt loam
93-2	Peoria	0.2-0.3	EB	0.52	73.80	25.68	Silt loam
93-3	Peoria	0.3-0.5	Bt	1.34	68.63	30.03	Silty clay loam
93-4	Peoria	0.5-0.6	Bt	1.20	68.06	30.74	Silty clay loam
93-6	Peoria	0.8-1.0	Bt2	4.09	71.93	23.98	Silt loam
93-9	Peoria	1.7-2.0	2C	35.30	40.26	24.44	Loam
10-1	Perry	0.0-0.2	Ap	3.58	70.18	26.24	Silt loam
10-2	Perry	0.2-0.4	EB	5.76	70.09	24.15	Silt loam
10-3	Perry	0.4-0.6	EB	10.84	65.31	23.85	Silt loam
10-5	Perry	0.8-1.1	B	15.42	59.52	25.06	Silt loam
10-10	Perry	1.8-2.1	B	16.00	52.52	31.48	Silty clay loam
10-16	Perry	3.5-3.7	BC	35.70	44.82	19.48	Loam
9-1	Perry	0.0-0.2	Ap	5.55	79.01	15.44	Silt loam
9-2	Perry	0.2-0.4	E	5.07	80.25	14.68	Silt loam
9-3	Perry	0.4-0.5	E	4.85	76.15	19.00	Silt loam
9-7	Perry	0.8-1.0	B	2.34	63.34	34.32	Silty clay loam
9-12	Perry	1.9-2.0	B	8.26	72.24	19.50	Silt loam
9-20	Perry	4.4-4.6	3B	33.20	38.25	28.55	Clay loam
45-1	Pike	0.0-0.3	Ap	1.12	85.24	13.64	Silt loam
45-2	Pike	0.3-0.6	E1	0.89	77.28	21.83	Silt loam
45-3	Pike	0.6-0.9	E2	1.04	69.28	29.68	Silty clay loam
45-5	Pike	1.0-1.2	Bt	1.37	67.52	31.11	Silty clay loam
45-9	Pike	1.8-2.0	C	1.32	79.76	18.92	Silt loam
45-17	Pike	3.7-4.0	2Bt	0.80	51.57	47.63	Silt loam
58-1	Pike	0.0-0.3	Ap	2.71	82.73	14.56	Silt loam
58-2	Pike	0.3-0.4	E	1.61	80.51	17.88	Silt loam
58-3	Pike	0.4-0.6	Bt	0.68	60.22	39.10	Silty clay loam
58-4	Pike	0.6-0.9	Bt	0.59	62.17	37.24	Silty clay loam
58-7	Pike	1.2-1.4	Btj	0.72	69.96	29.32	Silty clay loam
58-10	Pike	1.7-2.0	C	0.43	83.59	15.98	Silt loam
58-31	Pike	5.6-5.7	2Ab	0.34	85.58	14.08	Silt loam
59-1	Pike	0.0-0.1	Ap	0.73	73.32	25.95	Silt loam
59-2	Pike	0.1-0.3	Bt	0.57	66.76	32.67	Silty clay loam

*Continued on next page*



Electronic Filing: Received, Clerk's Office 3/24/2022

Sample ID	County	Depth interval (m)	Horizon	Sand (%)	Silt (%)	Clay (%)	Texture
59-3	Pike	0.3–0.5	Bt	0.68	64.97	34.35	Silty clay loam
59-6	Pike	0.9–1.0	Bt	0.60	69.32	30.08	Silty clay loam
59-13	Pike	2.1–2.2	3EB	2.86	73.46	23.68	Silt loam
59-16	Pike	2.5–2.7	4Bt	13.50	61.92	24.58	Silt loam
4-1	Pope	0.0–0.2	A	1.81	62.43	35.76	Silty clay loam
4-2	Pope	0.2–0.3	A	2.19	58.94	38.87	Silty clay loam
4-3	Pope	0.3–0.5	AB	5.26	54.06	40.68	Silty clay
4-4	Pope	0.5–0.6	B	5.21	53.65	41.14	Silty clay
4-8	Pope	1.1–1.2	B	3.06	54.38	42.56	Silty clay
4-12	Pope	1.7–1.8	B	1.62	60.16	38.22	Silty clay loam
5-1	Pope	0.0–0.1	A	1.27	80.85	17.88	Silt loam
5-2	Pope	0.1–0.2	E	2.80	83.30	13.90	Silt loam
5-3	Pope	0.2–0.4	B	2.56	75.90	21.54	Silt loam
5-4	Pope	0.4–0.6	B	1.92	70.72	27.36	Silt loam
5-7	Pope	1.2–1.5	B	1.48	81.12	17.40	Silt loam
5-14	Pope	2.4–2.6	3EB	21.33	58.09	20.58	Silt loam
1-1	Pulaski	0.0–0.2	Ap	3.69	56.65	39.66	Silty clay loam
1-2	Pulaski	0.2–0.3	AB	2.69	56.12	41.19	Silty clay
1-3	Pulaski	0.3–0.5	BA	1.70	53.63	44.67	Silty clay
1-4	Pulaski	0.5–0.6	B	1.51	52.81	45.68	Silty clay
1-8	Pulaski	1.2–1.4	B	1.06	46.90	52.04	Silty clay
1-11	Pulaski	2.4–2.6	B	0.88	44.09	55.03	Silt loam
105-1	Putnam	0.0–0.3	Ap	1.88	71.80	26.32	Silt loam
105-2	Putnam	0.3–0.5	AB	1.15	64.74	34.11	Silty clay loam
105-3	Putnam	0.5–0.6	Bt	1.61	63.17	35.22	Silty clay loam
105-5	Putnam	0.8–1.0	Bt2	2.69	71.21	26.10	Silt loam
105-7	Putnam	1.2–1.4	2C	19.34	46.68	33.98	Silty clay loam
105-12	Putnam	2.2–2.4	2C	20.58	45.92	33.50	Clay loam
33-1	Richland	0.0–0.2	Ap	12.10	64.98	23.22	Silt loam
33-2	Richland	0.2–0.3	A2	10.07	64.77	25.16	Silt loam
33-3	Richland	0.3–0.5	AB	7.79	74.63	17.58	Silt loam
33-4	Richland	0.5–0.6	B1	7.04	74.04	18.92	Silt loam
33-6	Richland	0.7–1.3	B3	10.99	56.03	32.98	Silty clay loam
33-10	Richland	2.6–2.7	C3g	17.76	43.27	38.97	Silty clay loam
6-1	Saline	0.0–0.2	Ap	13.81	62.95	23.24	Silt loam
6-2	Saline	0.2–0.5	B	5.54	47.88	46.58	Silty clay
6-3	Saline	0.5–0.7	B	4.28	45.00	50.72	Silty clay
6-4	Saline	0.7–1.0	B	4.24	47.34	48.42	Silty clay
6-6	Saline	1.1–1.3	B	6.02	47.85	46.13	Silty clay
6-20	Saline	3.8–4.0	2B	0.48	53.12	46.40	Silty clay
55-1	Sangamon	0.0–0.2	A	2.35	72.53	25.12	Silt loam
55-3	Sangamon	0.3–0.5	A	9.01	72.24	18.75	Silt loam
55-6	Sangamon	0.9–1.1	A	20.52	59.68	19.80	Silt loam
55-8	Sangamon	1.3–1.5	A	26.56	54.16	19.38	Silt loam
55-11	Sangamon	2.1–2.3	Bw	29.66	51.30	19.04	Silt loam
55-28	Sangamon	5.2–5.6	2C	0.05	19.18	80.77	Clay
56-1	Sangamon	0.0–0.2	A	1.93	71.28	26.79	Silt loam
56-2	Sangamon	0.2–0.5	A	1.33	70.08	28.59	Silty clay loam
56-3	Sangamon	0.5–0.6	AB	2.91	66.01	31.08	Silty clay loam
56-5	Sangamon	0.8–1.0	Bt	4.39	62.10	33.51	Silty clay loam
56-7	Sangamon	1.2–1.5	Bt	2.50	70.26	27.24	Silty clay loam
56-11	Sangamon	2.6–2.7	C	0.68	84.18	15.14	Silt loam
50-1	Shelby	0.0–0.2	Ap	5.44	67.40	27.16	Silty clay loam
50-2	Shelby	0.2–0.4	AB	3.16	63.81	33.03	Silty clay loam
50-3	Shelby	0.4–0.6	BA	4.73	60.45	34.82	Silty clay loam
50-5	Shelby	0.8–1.1	Bt	23.68	44.55	31.77	Clay loam
50-7	Shelby	1.2–1.5	C	29.98	45.34	24.68	Loam
50-16	Shelby	3.1–3.4	D	30.09	47.25	22.66	Loam

Continued on next page

Electronic Filing: Received, Clerk's Office 3/24/2022

Sample ID	County	Depth interval (m)	Horizon	Sand (%)	Silt (%)	Clay (%)	Texture
27-1	St. Clair	0.0–0.2	Ap	1.91	86.38	11.71	Silt
27-2	St. Clair	0.2–0.3	A2	1.88	82.08	16.04	Silt loam
27-3	St. Clair	0.3–0.5	B	1.74	73.23	25.03	Silt loam
27-4	St. Clair	0.5–0.8	B2	1.36	67.65	30.99	Silty clay loam
27-9	St. Clair	1.9–2.1	C2	1.07	81.55	17.38	Silt loam
27-13	St. Clair	3.6–3.9	2A	0.65	84.93	14.42	Silt loam
121-1	Stephenson	0.0–0.2	Ap	3.74	72.64	23.62	Silt loam
121-2	Stephenson	0.2–0.4	C	0.96	79.00	20.04	Silt loam
121-3	Stephenson	0.4–0.6	2A1	1.24	76.96	21.80	Silt loam
121-5	Stephenson	0.8–1.0	3Ab	1.94	76.44	21.62	Silt loam
121-8	Stephenson	1.3–1.5	3BA	1.71	66.29	32.00	Silty clay loam
121-10	Stephenson	1.7–1.9	3CB	0.94	70.08	28.98	Silty clay loam
86-1	Tazewell	0.0–0.2	Ap	4.10	79.64	16.26	Silt loam
86-2	Tazewell	0.2–0.4	E	4.21	86.08	9.71	Silt
86-3	Tazewell	0.4–0.6	Bt	1.86	56.61	41.53	Silty clay
86-5	Tazewell	0.8–1.0	Bt	2.10	64.59	33.31	Silty clay loam
86-7	Tazewell	1.2–1.5	B3	1.47	70.32	28.21	Silty clay loam
86-12	Tazewell	2.1–2.3	C	1.98	80.62	17.40	Silt loam
2-1	Union	0.0–0.2	Ap	0.76	79.64	19.60	Silt loam
2-2	Union	0.2–0.4	B	0.90	73.47	25.63	Silt loam
2-3	Union	0.4–0.6	B	3.00	73.66	23.34	Silt loam
2-4	Union	0.6–0.8	E	3.84	73.94	22.22	Silt loam
2-6	Union	0.8–1.2	2B	3.06	71.50	25.44	Silt loam
2-13	Union	2.4–3.1	2A	0.62	82.26	17.12	Silt loam
2-26	Union	4.9–5.2	4B	0.60	75.75	23.65	Silt loam
68-1	Vermilion	0.0–0.2	Ap	5.94	70.22	23.84	Silt loam
68-2	Vermilion	0.2–0.4	AB	1.18	60.71	38.11	Silt loam
68-3	Vermilion	0.4–0.6	Btg	1.24	59.04	39.72	Silty clay loam
68-4	Vermilion	0.6–0.9	Btg	1.24	63.65	35.11	Silty clay loam
68-6	Vermilion	1.0–1.2	2BC	50.10	32.46	17.44	Loam
68-9	Vermilion	1.7–1.8	2C	28.28	51.10	20.62	Silt loam
69-1	Vermilion	0.0–0.2	Ap	6.03	54.11	39.86	Silty clay loam
69-3	Vermilion	0.4–0.6	A	19.66	43.87	36.47	Silty clay loam
69-4	Vermilion	0.6–0.9	A	24.08	38.22	37.70	Clay loam
69-5	Vermilion	0.9–1.1	AB	37.12	31.66	31.87	Clay loam
69-8	Vermilion	1.4–1.8	2C1	15.99	57.44	26.57	Silt loam
69-11	Vermilion	2.1–2.4	2C2	18.42	55.62	25.96	Silt loam
23-01	Wabash	0.0–0.2	A	4.78	79.02	16.20	Silt loam
23-02	Wabash	0.2–0.3	A	2.65	82.43	14.92	Silt loam
23-03	Wabash	0.3–0.5	B	1.26	77.84	20.90	Silt loam
23-04	Wabash	0.5–0.7	A'	0.56	67.56	31.88	Silty clay loam
23-08	Wabash	1.5–1.8	C	0.96	77.20	21.84	Silt loam
23-14	Wabash	3.1–3.4	C	30.77	41.07	28.16	Clay loam
90-1	Warren	0.0–0.3	Ap	2.40	74.25	23.35	Silt loam
90-2	Warren	0.3–0.5	BA	1.48	72.05	26.47	Silt loam
90-3	Warren	0.5–0.7	Btj	1.41	69.93	28.66	Silty clay loam
90-5	Warren	0.9–1.1	Bw	1.61	68.87	29.52	Silty clay loam
90-7	Warren	1.3–1.5	BCtj	1.24	73.21	25.55	Silt loam
90-11	Warren	2.1–2.3	C	0.99	80.05	18.96	Silt loam
14-01	Washington	0.0–0.1	Ap	7.31	78.45	14.24	Silt loam
14-02	Washington	0.1–0.2	Ap	6.15	79.45	14.40	Silt loam
14-03	Washington	0.2–0.4	Ap	4.39	79.39	16.22	Silt loam
14-04	Washington	0.4–0.6	E	4.04	67.52	28.44	Silty clay loam
14-06	Washington	0.9–1.1	B	3.86	63.46	32.68	Silty clay loam
14-15	Washington	2.0–2.2	2B	12.08	64.96	22.96	Silt loam
15-01	Washington	0.0–0.3	A	1.49	80.07	18.44	Silt loam
15-02	Washington	0.3–0.5	A	2.79	78.37	18.84	Silt loam
15-03*	Washington	0.5–0.6	E				
15-04	Washington	0.9–1.0	B	1.43	40.81	57.76	Silty clay

Continued on next page

## Electronic Filing: Received, Clerk's Office 3/24/2022

Sample ID	County	Depth interval (m)	Horizon	Sand (%)	Silt (%)	Clay (%)	Texture
15-13	Washington	2.1-2.7	B	10.28	61.66	28.06	Silty clay
15-20	Washington	4.6-4.9	C	25.53	41.17	32.30	Clay loam
21-01	Wayne	0.0-0.1	A	5.68	71.64	22.68	Silt loam
21-02	Wayne	0.1-0.3	A	5.94	71.54	22.52	Silt loam
21-03	Wayne	0.3-0.6	E	9.08	72.08	18.84	Silt loam
21-04	Wayne	0.6-0.9	B	3.28	52.47	44.25	Silty clay
21-07	Wayne	1.4-1.8	B	7.60	62.02	30.38	Silty clay loam
21-10	Wayne	2.0-2.3	B	11.68	52.97	35.35	Silty clay loam
25-01	Wayne	0.0-0.2	A	6.12	75.20	18.68	Silt loam
25-02	Wayne	0.2-0.3	C	6.01	74.96	19.03	Silt loam
25-03	Wayne	0.3-0.6	C	6.09	71.39	22.52	Silt loam
25-04	Wayne	0.6-0.9	C	5.36	66.88	27.76	Silt loam
25-22	Wayne	2.6-2.7	2C	3.70	58.44	37.86	Silty clay loam
25-29	Wayne	4.4-4.8	2C	10.46	53.86	35.68	Silty clay loam
13-01	White	0.0-0.2	Ap	68.39	23.77	7.84	Sandy loam
13-02	White	0.2-0.4	B	60.67	26.93	12.40	Sandy loam
13-03	White	0.4-0.6	B	57.53	22.55	19.92	Sandy loam
13-04	White	0.6-0.9	B	64.53	16.87	18.60	Sandy loam
13-05	White	3.2-4.0	C	92.05	2.93	5.02	Sand
117-1	Whiteside	0.0-0.2	Ap	25.94	53.07	20.99	Silt loam
117-2	Whiteside	0.2-0.4	A2	37.24	49.17	13.59	Loam
117-3	Whiteside	0.4-0.6	Ab	41.06	47.34	11.60	Loam
117-5	Whiteside	0.9-1.1	Ab	50.59	38.77	10.64	Loam
117-6	Whiteside	1.1-1.3	Ab	54.74	33.38	9.88	Sandy loam
117-8	Whiteside	1.5-1.7	AB	57.07	34.34	8.59	Sandy loam
127-1	Will	0.0-0.2	A	6.15	56.18	37.67	Silty clay loam
127-3	Will	0.3-0.5	Bgtj	4.59	49.25	46.16	Silty clay
127-4	Will	0.5-0.7	BCK	7.27	50.29	42.03	Silty clay
127-5	Will	0.7-0.9	BCK	7.74	49.87	42.39	Silty clay
127-6	Will	0.9-1.0	BCK	4.59	52.29	42.83	Silty clay
127-7	Will	1.0-1.2	C	2.54	54.62	42.63	Silty clay
137-1	Will	0.0-0.3	Ap	6.44	61.74	31.82	Silty clay loam
137-2	Will	0.3-0.5	B1t	3.70	56.33	39.97	Silty clay loam
137-3	Will	0.5-0.6	B2tj	7.22	57.02	35.76	Silty clay loam
137-4	Will	0.6-0.8	B2tj	13.02	49.60	37.38	Silty clay loam
137-5	Will	0.8-1.0	B3t	11.94	49.16	38.90	Silty clay loam
137-6	Will	1.0-1.2	2C	11.40	51.58	37.02	Silty clay loam
7-1	Williamson	0.0-0.2	A	3.10	79.22	17.68	Silt loam
7-2	Williamson	0.2-0.3	BA	1.06	74.18	24.76	Silt loam
7-3	Williamson	0.3-0.5	B	1.22	70.46	28.32	Silt loam
7-6	Williamson	0.7-0.9	B	0.52	72.14	27.34	Silt loam
7-21	Williamson	3.8-4.3	BE	5.46	79.12	15.42	Silt loam
124-1	Winnebago	0.0-0.2	Ap	61.47	24.10	14.43	Sandy loam
124-2	Winnebago	0.2-0.3	Btj	61.73	22.47	15.80	Sandy loam
124-3	Winnebago	0.3-0.5	C	60.32	28.10	11.58	Sandy loam
124-4	Winnebago	0.5-0.6	C	60.26	29.03	10.71	Sandy loam
124-5	Winnebago	0.6-0.8	C	57.30	31.65	11.05	Sandy loam
124-7	Winnebago	1.0-1.2	C	58.52	31.28	10.20	Sandy loam
87-1	Woodford	0.0-0.2	Ap	4.45	78.08	17.47	Silt loam
87-2	Woodford	0.4-0.5	AE	4.29	80.15	15.56	Silt loam
87-3	Woodford	0.4-0.6	EB	4.12	82.52	13.36	Silt loam
87-4	Woodford	0.6-0.8	Bt	1.46	65.00	33.54	Silty clay loam
87-5	Woodford	0.8-1.0	BC	1.16	74.65	24.19	Silt loam
87-6	Woodford	1.0-1.2	C	1.04	80.58	18.38	Silt loam
94-1	Woodford	0.0-0.3	Ap	2.86	67.56	29.58	Silty clay loam
94-2	Woodford	0.3-0.5	A	2.90	64.65	32.45	Silty clay loam
94-4	Woodford	0.6-0.8	Bgt	3.02	64.19	32.79	Silty clay loam
94-6	Woodford	0.9-1.1	Bgtj	2.36	68.26	29.38	Silty clay loam
94-8	Woodford	1.3-1.4	C	2.64	83.78	13.58	Silt loam
94-12	Woodford	2.0-2.2	2C	68.86	24.44	6.70	Sandy loam



**APPENDIX 5—LABORATORY NUMBER, SAMPLE IDENTIFICATION,  
COUNTY, HORIZON, DEPTH INTERVAL, ELEMENTAL CONCENTRATIONS, AND pH  
(DREHER AND FOLLMER SERIES)**

Note: An asterisk (\*) indicates data from this core were excluded when calculating the means and ranges of element contents in the uppermost samples.

Lab no.	Sample ID	County	Horizon	Depth interval (m)	SiO <sub>2</sub> (%)	Al <sub>2</sub> O <sub>3</sub> (%)	Fe <sub>2</sub> O <sub>3</sub> (%)	MgO (%)	CaO (%)	Na <sub>2</sub> O (%)	K <sub>2</sub> O (%)
R22313	60-01	Adams	Ap	0.0–0.1	77.60	8.20	2.41	0.32	0.77	1.09	1.82
R22314	60-02	Adams	Ap2	0.1–0.4	82.30	7.20	2.44	0.24	0.40	0.94	1.85
R22315	60-03	Adams	E	0.4–0.5	82.80	7.36	2.72	0.23	0.34	1.00	1.90
R22316	60-06	Adams	Bt2	0.6–0.9	69.00	14.40	6.68	0.97	0.44	0.69	1.68
R22317	60-21	Adams	Btt	3.4–3.5	76.60	11.00	5.30	0.44	0.21	0.34	1.08
R22318	60-40	Adams	C	7.2–7.3	74.50	8.90	4.70	1.12	2.64	0.49	1.37
R22110	29-01	Bond	Ap	0.0–0.2	78.40	8.40	2.43	0.47	0.76	0.97	1.87
R22111	29-02	Bond	A1	0.2–0.3	78.40	9.10	2.51	0.53	0.69	1.03	2.00
R22112	29-03	Bond	AE	0.3–0.4	78.50	9.50	2.59	0.55	0.60	1.05	2.06
R22113	29-04	Bond	E	0.4–0.7	72.40	12.80	4.68	1.07	0.55	0.88	1.97
R22114	29-09	Bond	C1	2.1–2.4	84.40	7.10	2.26	0.35	0.48	0.90	1.68
R22115	29-14	Bond	2A	3.7–3.9	84.90	6.20	4.07	0.18	0.23	0.37	1.24
R23522	125-1	Boone	Ap1	0.0–0.3	78.76	9.92	3.16	1.09	1.18	1.01	2.22
R23523	125-2	Boone	Ap2	0.3–0.4	74.53	9.52	3.26	1.08	1.25	0.93	1.99
R23524	125-3	Boone	Bg	0.4–0.6	75.18	11.00	4.09	1.22	1.07	1.00	2.18
R23525	125-4	Boone	Bg	0.6–0.8	71.56	12.14	5.67	1.48	1.24	0.93	2.10
R23526	125-6	Boone	BCg	1.0–1.1	85.24	6.89	1.75	0.90	0.91	0.63	1.66
R23527	125-10	Boone	3C	1.8–2.1	57.39	6.94	3.16	5.34	8.42	0.52	2.26
R22329	61-01	Brown	Ap	0.0–0.2	72.40	7.90	3.54	0.97	3.70	0.83	1.93
R22330	61-02	Brown	Bt1	0.2–0.4	71.40	13.00	5.88	1.00	0.69	0.62	2.00
R22331	61-03	Brown	Bt1	0.4–0.6	72.10	12.70	6.11	0.97	0.49	0.63	2.07
R22332	61-04	Brown	Bt2	0.6–0.8	72.30	12.20	6.40	0.89	0.47	0.68	2.11
R22333	61-10	Brown	C	1.9–2.1	75.30	10.20	5.54	0.70	1.14	1.24	2.17
R22334	61-18	Brown	2Bt	3.5–3.7	75.40	11.30	5.83	0.52	0.37	0.40	1.33
R23338	106-1	Bureau	Ap	0.0–0.2	71.80	11.67	4.25	1.27	1.09	0.91	2.12
R23339	106-2	Bureau	BA	0.2–0.4	71.06	12.93	4.88	1.32	0.95	0.90	2.03
R23340	106-3	Bureau	Bt	0.4–0.6	71.23	12.80	5.01	1.32	0.97	1.48	2.10
R23341	106-4	Bureau	Bt	0.6–0.8	72.43	12.48	5.08	1.33	1.01	1.07	2.10
R23342	106-6	Bureau	B2tj	1.0–1.2	75.78	10.56	4.40	1.17	1.22	1.23	2.26
R23343	106-8	Bureau	C	1.3–1.5	60.10	8.17	3.06	4.96	7.36	1.00	1.91
R23402	112-1	Bureau	Ap1	0.0–0.3	75.45	9.15	2.93	1.14	1.46	1.15	2.08
R23403	112-3	Bureau	Btj	0.3–0.6	72.72	12.76	4.09	1.17	1.00	1.15	2.08
R23404	112-4	Bureau	Btj	0.6–0.7	73.24	12.01	4.60	1.26	1.11	1.22	2.02
R23405	112-6	Bureau	Btj	0.9–1.0	74.38	11.74	4.20	1.19	1.35	1.48	1.97
R23406	112-8	Bureau	BCtj	1.2–1.4	76.14	11.03	3.68	1.11	1.40	1.50	1.99
R23407	112-10	Bureau	C	1.5–1.7	75.97	11.11	3.74	1.14	1.41	1.50	2.01
R23408	113-1	Bureau	Ap	0.0–0.2	72.10	11.86	3.88	1.15	1.15	1.09	1.98
R23409	113-2	Bureau	Btj	0.2–0.4	70.11	13.88	5.08	1.40	1.21	1.05	1.89
R23410	113-3	Bureau	Bt	0.4–0.6	71.20	13.39	4.93	1.35	1.27	1.20	1.96
R23411	113-4	Bureau	Bt	0.6–0.7	71.20	12.25	4.40	1.68	1.96	1.23	2.09
R23412	113-5	Bureau	BCtj	0.7–0.9	60.00	9.73	3.29	4.27	7.02	1.09	1.87
R23413	113-6	Bureau	C	1.4–1.6	54.68	8.39	3.05	5.37	9.57	0.96	1.82
R23455	118-1	Carroll	Ap	0.0–0.3	75.68	8.96	2.70	1.33	1.73	1.21	2.11
R23456	118-2	Carroll	Btj	0.3–0.5	75.00	11.53	3.79	1.11	1.02	1.16	2.20
R23457	118-3	Carroll	Btj	0.5–0.6	73.73	12.16	4.35	1.23	1.02	1.16	2.14
R23458	118-5	Carroll	Bt	0.8–1.0	73.07	12.51	4.60	1.27	1.18	1.29	2.05
R23459	118-8	Carroll	Bt	1.4–1.6	71.66	14.02	4.42	1.28	1.16	1.30	2.13
R23460	118-11	Carroll	Ctj	2.0–2.3	75.13	11.59	3.97	1.16	1.31	1.41	2.30
R22335	62-01	Cass	Ap	0.0–0.2	91.20	3.60	1.22	0.07	0.26	0.58	1.31
R22336	62-02	Cass	AB	0.2–0.4	91.60	3.50	1.23	0.07	0.25	0.55	1.32
R22337	62-03	Cass	AB	0.4–0.6	91.60	3.40	1.25	0.07	0.23	0.52	1.30

Continued on next page

# Electronic Filing: Received, Clerk's Office 3/24/2022

Lab no.	Sample ID	County	Horizon	Depth interval (m)	SiO <sub>2</sub> (%)	Al <sub>2</sub> O <sub>3</sub> (%)	Fe <sub>2</sub> O <sub>3</sub> (%)	MgO (%)	CaO (%)	Na <sub>2</sub> O (%)	K <sub>2</sub> O (%)
R22338	62-05	Cass	BA	0.9–1.1	92.20	3.06	1.21	0.06	0.24	0.53	1.34
R22339	62-07	Cass	Bw	1.3–1.5	91.60	3.60	1.28	0.10	0.20	0.51	1.27
R22340	62-17	Cass	Bâ	3.2–3.4	91.60	3.70	1.30	0.10	0.22	0.46	1.15
R22341	62-18	Cass	C	3.4–3.5	93.60	2.80	0.71	<0.05	0.22	0.50	1.17
R22359	65-01	Champaign	Ap	0.0–0.2	74.60	10.10	4.01	0.59	0.60	0.73	1.97
R22360	65-02	Champaign	A2	0.2–0.4	72.30	11.50	4.59	0.73	0.60	0.69	1.98
R22361	65-03	Champaign	BAt	0.4–0.6	70.10	12.90	6.57	0.92	0.48	0.49	1.85
R22362	65-04	Champaign	Bt	0.6–0.8	71.40	12.10	6.72	0.89	0.52	0.60	1.93
R22363	65-05	Champaign	Btj	0.8–1.1	73.20	11.20	5.57	0.98	0.73	0.89	2.22
R22364	65-11	Champaign	3C	1.9–2.1	59.80	9.04	4.00	4.31	7.26	0.45	3.22
R22512	70-01	Champaign	Ap	0.0–0.4	74.30	9.76	3.92	0.63	0.55	0.63	2.23
R22513	70-02	Champaign	A	0.4–0.6	71.30	10.10	4.15	0.76	0.92	0.51	2.07
R22514	70-03	Champaign	AB	0.6–0.9	74.30	10.60	4.28	0.79	0.77	0.55	2.06
R22515	70-04	Champaign	BA	0.9–1.1	74.40	12.20	4.06	0.97	0.74	0.78	2.13
R22516	70-05	Champaign	Bg	1.1–1.3	76.40	10.60	3.91	0.86	0.72	0.72	2.11
R22517	70-08	Champaign	B3â	1.7–2.0	79.40	5.73	3.03	1.73	2.24	0.74	1.89
R22518	71-01	Champaign	Ap	0.0–0.2	67.90	9.60	4.42	2.09	3.01	0.78	2.25
R22519	71-02	Champaign	AB	0.2–0.4	71.00	11.60	5.44	0.97	0.85	0.68	2.16
R22520	71-03	Champaign	Btj	0.4–0.6	71.60	12.00	6.03	0.96	0.74	0.78	2.25
R22521	71-04	Champaign	CB	0.6–0.7	59.80	7.40	3.77	4.76	8.14	0.81	1.90
R22522	71-05	Champaign	C	0.7–0.9	53.60	6.30	3.03	5.80	12.13	0.78	1.71
R22523	71-10	Champaign	2C	1.7–1.9	54.60	11.70	4.99	4.47	7.37	0.32	4.06
R22698	76-01	Champaign	Ap	0.0–0.3	75.50	10.60	3.39	0.50	0.43	0.78	1.95
R22699	76-03	Champaign	Bt	0.4–0.6	67.30	16.00	5.92	1.24	0.66	0.88	1.90
R22700	76-04	Champaign	Bt	0.6–0.8	68.90	15.20	5.37	1.22	0.73	1.00	2.04
R22701	76-05	Champaign	Btj	0.8–1.0	71.40	13.80	4.93	1.15	0.77	1.13	2.24
R22702	76-06	Champaign	BC	1.0–1.2	71.30	13.60	5.21	1.14	0.76	1.08	2.34
R22703	76-08	Champaign	Câ	1.3–1.4	66.90	10.30	3.32	3.77	3.92	0.67	2.77
R22246	49-01	Christian	Ap	0.0–0.2	76.90	9.70	2.92	0.55	0.90	1.03	2.01
R22247	49-02	Christian	Ap2	0.2–0.4	73.60	11.90	4.20	0.84	0.92	0.94	1.80
R22248	49-03	Christian	BAt	0.4–0.6	72.10	13.20	4.52	1.09	0.94	0.96	1.78
R22250	49-05	Christian	Bgt2	0.8–1.1	72.40	11.60	6.44	0.95	0.86	1.01	2.04
R22251	49-07	Christian	CBtj	1.3–1.4	75.80	11.30	3.68	0.79	1.13	1.43	2.17
R22252	49-21	Christian	Bg	3.8–4.0	75.70	10.30	5.65	0.88	0.70	0.83	2.22
R22276	54-01	Christian	Ap	0.0–0.2	71.80	10.10	4.03	0.86	1.43	0.93	2.08
R22277	54-03	Christian	AB	0.4–0.6	69.08	13.14	6.27	1.06	0.78	0.77	1.86
R22278	54-04	Christian	B1	0.6–0.7	69.50	11.90	7.91	0.99	0.69	0.86	1.96
R22279	54-05	Christian	Bt	0.7–0.9	71.90	12.40	5.72	1.08	0.81	1.02	2.09
R22280	54-07	Christian	C	1.1–1.2	62.10	8.10	3.00	4.97	6.74	1.00	2.20
R22281	54-14	Christian	2Ab	2.2–2.4	76.30	11.50	2.67	0.75	1.08	1.46	2.05
R22162	36-01	Clark	Ap	0.0–0.3	80.40	8.10	2.42	0.40	0.48	0.96	2.02
R22163	36-02	Clark	EB1	0.3–0.4	78.00	9.90	3.33	0.63	0.47	0.89	2.17
R22164	36-03	Clark	EB2	0.4–0.7	74.70	11.10	4.51	0.91	0.41	0.91	2.27
R22165	36-04	Clark	B1	0.7–0.9	73.60	11.90	4.86	0.99	0.40	1.08	2.37
R22166	36-06	Clark	Btx2	1.4–1.6	83.90	7.20	2.56	0.41	0.37	0.82	1.68
R22167	36-08	Clark	C1	2.1–2.4	77.60	10.70	4.27	0.60	0.30	0.46	1.68
R22138	32-01	Clay	Ap	0.0–0.2	80.90	7.50	2.33	0.29	0.94	0.81	1.63
R22139	32-02	Clay	Eg1	0.2–0.5	79.80	8.70	2.83	0.31	0.45	0.83	1.70
R22140	32-03	Clay	Eg2	0.5–0.8	80.50	9.70	3.17	0.41	0.37	0.84	1.75
R22141	32-04	Clay	Btg	0.8–1.4	72.50	13.80	5.48	0.88	0.55	0.80	1.79
R22142	32-06	Clay	C1	1.4–2.1	77.30	11.70	2.70	0.69	0.73	0.92	1.66
R22143	32-11	Clay	C6	4.3–4.9	64.30	7.70	2.94	3.97	6.76	0.88	1.99
R22013	18-01	Clinton	A	0.0–0.1	82.18	7.02	1.34	0.28	0.92	1.23	1.85
R22014	18-02	Clinton	A	0.1–0.2	83.29	7.04	1.32	0.24	0.75	1.25	1.82
R22015	18-03	Clinton	A	0.2–0.3	83.82	7.36	1.43	0.24	0.61	1.26	1.89
R22016	18-04	Clinton	E	0.3–0.5	84.03	7.36	1.46	0.24	0.55	1.32	1.92
R22017	18-10	Clinton	B	1.0–1.3	71.80	12.70	5.09	1.06	0.84	1.17	1.98

*Continued on next page*

Electronic Filing: Received, Clerk's Office 3/24/2022

Lab no.	Sample ID	County	Horizon	Depth interval (m)	SiO <sub>2</sub> (%)	Al <sub>2</sub> O <sub>3</sub> (%)	Fe <sub>2</sub> O <sub>3</sub> (%)	MgO (%)	CaO (%)	Na <sub>2</sub> O (%)	K <sub>2</sub> O (%)
R22018	18-16	Clinton	C	2.4-3.1	81.54	9.00	2.25	0.50	0.70	1.08	1.69
R22019	19-01	Clinton	A	0.0-0.1	66.88	6.12	2.14	1.17	8.73	0.83	1.35
R22020	19-02	Clinton	A	0.1-0.2	81.15	7.52	2.64	0.31	0.71	1.04	1.53
R22021	19-03	Clinton	E	0.2-0.3	78.30	8.86	3.66	0.43	0.42	1.08	1.65
R22022	19-04	Clinton	B	0.3-0.4	70.10	13.70	5.50	0.92	0.42	0.87	1.54
R22023	19-05	Clinton	B	0.4-0.6	68.60	14.66	5.73	1.16	0.48	0.95	1.57
R22024	19-13	Clinton	2B	1.7-2.1	77.81	10.30	3.49	0.68	0.79	1.18	1.75
R22173	37-01	Coles	Ap	0.0-0.2	78.00	8.90	2.66	0.52	0.73	1.05	2.12
R22174	37-02	Coles	A	0.2-0.4	72.60	12.40	4.12	0.95	0.75	0.93	2.12
R22175	37-03	Coles	AB	0.4-0.5	68.50	14.60	5.22	1.35	0.83	0.82	2.08
R22176	37-04	Coles	Bt1	1.5-0.8	68.80	14.10	5.53	1.43	0.86	0.90	2.21
R22177	37-08	Coles	2A1	1.5-1.8	77.60	9.80	3.65	0.99	0.62	0.90	2.75
R22178	37-11	Coles	2Bt4	2.2-2.4	71.00	11.20	3.29	2.24	2.21	1.04	2.66
R22258	51-01	Coles	Ap	0.0-0.2	78.90	8.60	3.32	0.43	0.40	0.70	1.98
R22259	51-02	Coles	Ap2	0.2-0.4	77.00	9.70	3.84	0.54	0.40	0.80	1.92
R22260	51-03	Coles	BA	0.4-0.6	68.70	14.00	6.30	1.14	0.65	0.72	1.90
R22261	51-04	Coles	Bt	0.6-0.8	68.60	14.60	6.38	1.17	0.72	0.72	1.98
R22262	51-06	Coles	B/C	1.1-1.2	74.20	11.10	4.53	1.30	0.99	0.72	2.65
R22263	51-21	Coles	D	4.1-4.2	57.00	8.20	3.00	4.81	9.34	0.54	2.55
R23540	128-1	Cook	A1	0.0-0.2	64.18	9.55	4.35	1.92	2.75	0.79	1.97
R23541	128-2	Cook	A2	0.2-0.3	71.18	10.81	3.90	1.26	1.36	0.71	2.20
R23542	128-3	Cook	Bwcalc	0.3-0.6	72.72	6.74	1.19	2.98	4.83	1.07	2.00
R23543	128-4	Cook	Bwcalc	0.6-0.8	71.81	6.58	1.16	3.29	5.23	1.05	1.97
R23544	128-7	Cook	Ab2	1.0-1.1	69.73	7.26	1.42	2.98	4.53	0.99	1.96
R23545	128-9	Cook	C2	1.2-1.4	68.76	6.76	1.28	3.67	6.17	1.00	1.94
R23750	130-1	Cook	A	0.0-0.2	65.08	11.18	4.43	1.38	1.50	0.68	2.51
R23751	130-3	Cook	B1	0.4-0.6	69.50	12.19	4.65	1.57	1.58	0.78	2.30
R23752	130-5	Cook	B2g	0.7-0.9	71.00	12.38	5.12	1.64	1.42	0.86	2.60
R23753	130-8	Cook	CBg	1.2-1.3	69.66	12.96	3.95	1.61	1.83	0.95	2.79
R23754	130-12	Cook	CD	1.6-1.8	51.27	9.88	4.32	3.99	8.17	0.67	2.59
R23755	130-13	Cook	D	1.8-2.0	51.97	10.02	4.50	4.30	7.24	0.64	2.69
R22156	35-01	Crawford	Ap	0.0-0.2	61.40	7.40	2.31	0.36	0.67	1.07	1.99
R22157	35-02	Crawford	E	0.2-0.4	80.20	8.80	2.95	0.56	0.56	1.01	2.06
R22158	35-03	Crawford	BE	0.4-0.5	73.20	11.80	4.74	0.97	0.64	0.88	2.11
R22159	35-04	Crawford	Bt1	1.5-0.9	70.90	12.70	5.38	1.12	0.67	0.92	2.10
R22160	35-06	Crawford	Bt3	1.2-1.6	70.30	9.40	3.47	2.59	3.24	1.21	2.15
R22161	35-09	Crawford	B6	2.4-2.7	79.80	9.50	2.81	0.64	0.68	0.91	1.80
R23528	126-1	DeKalb	Ap	0.0-0.3	70.31	10.67	3.67	1.20	1.28	0.86	2.04
R23529	126-2	DeKalb	A2	0.3-0.5	68.94	12.03	4.16	1.38	1.53	0.88	1.93
R23530	126-3	DeKalb	AB	0.5-0.6	70.25	12.78	4.87	1.47	1.39	0.93	1.96
R23531	126-5	DeKalb	Bg	0.8-1.0	69.54	12.51	6.26	1.56	1.42	0.96	2.12
R23532	126-7	DeKalb	Bg	1.2-1.4	72.23	12.44	4.49	1.52	1.44	1.08	2.25
R23533	126-11	DeKalb	2C	1.8-2.0	58.75	7.71	2.75	5.24	8.01	0.64	2.43
R23774	134-1	DeKalb	Ap	0.0-0.2	71.59	10.52	3.70	1.28	1.36	0.80	2.09
R23775	134-2	DeKalb	B1	0.2-0.4	70.98	12.72	4.91	1.34	0.98	0.78	2.04
R23776	134-3	DeKalb	B2tj	0.4-0.6	70.42	13.22	5.28	1.45	1.02	0.82	2.04
R23777	134-4	DeKalb	B3t	0.6-0.8	71.33	12.54	5.19	1.52	1.20	0.88	2.14
R23778	134-5	DeKalb	B4t	0.8-1.0	74.00	11.15	4.82	1.34	1.07	0.81	2.56
R23779	134-6	DeKalb	C	1.0-1.2	55.54	7.82	2.92	5.99	8.48	0.52	2.38
R22264	52-1	Douglas	Ap	0.0-0.3	72.40	11.20	4.11	0.97	1.11	0.72	2.33
R22265	52-2	Douglas	BA	0.3-0.5	72.40	12.70	4.64	1.02	0.73	0.74	2.29
R22266	52-3	Douglas	Bg	0.5-0.6	72.20	12.50	4.57	1.06	0.78	0.72	2.35
R22267	52-5	Douglas	BCtj	0.9-1.0	72.30	12.10	5.81	1.08	0.72	0.83	2.62
R22268	52-7	Douglas	C	1.2-1.4	68.90	13.10	5.84	1.64	0.84	0.64	3.89
R22269	52-14	Douglas	DC	2.8-3.0	57.80	8.80	3.62	4.39	8.73	0.48	2.83
R22365	66-01	Douglas	Ap	0.0-0.3	78.50	8.70	3.58	0.61	0.56	0.76	2.03
R22366	66-02	Douglas	AB	0.3-0.5	69.40	14.00	6.05	1.07	0.57	0.58	1.96

Continued on next page

Electronic Filing: Received, Clerk's Office 3/24/2022

Lab no.	Sample ID	County	Horizon	Depth interval (m)	SiO <sub>2</sub> (%)	Al <sub>2</sub> O <sub>3</sub> (%)	Fe <sub>2</sub> O <sub>3</sub> (%)	MgO (%)	CaO (%)	Na <sub>2</sub> O (%)	K <sub>2</sub> O (%)
R22367	66-03	Douglas	BA	0.5–0.7	70.50	13.30	6.05	1.13	0.60	0.63	2.16
R22368	66-04	Douglas	Bg	0.7–0.9	72.50	12.10	5.65	1.11	0.63	0.70	2.32
R22369	66-05	Douglas	Bg	0.9–1.1	73.20	10.80	5.12	1.45	1.22	0.72	2.54
R22370	66-06	Douglas	C	1.1–1.3	64.20	8.00	4.05	3.83	6.17	0.44	2.67
R23744	129-1	DuPage	Bw	0.0–0.2	58.36	10.42	4.71	3.20	4.40	0.56	2.83
R23745	129-4	DuPage	C	0.8–1.1	53.87	9.88	4.54	4.14	6.75	0.56	2.85
R23746	129-5	DuPage	2Oa	1.1–1.3	51.06	10.42	3.56	1.32	2.65	0.55	1.98
R23747	129-6	DuPage	2Bg	1.3–1.5	65.96	11.98	4.18	1.52	1.71	0.89	2.51
R23748	129-7	DuPage	3Bg	1.5–1.6	62.94	9.54	3.46	3.71	5.09	0.89	2.22
R23749	129-11	DuPage	3C22	2.0–2.2	51.75	9.21	5.15	5.33	8.26	0.59	3.02
R22204	67-01	Edgar	Ap	0.0–0.2	72.00	8.90	4.42	1.70	2.63	0.56	2.39
R22205	67-02	Edgar	A	0.2–0.4	76.50	8.60	4.19	0.48	0.55	0.57	2.01
R22206	67-03	Edgar	A	0.4–0.6	74.30	10.50	4.50	0.60	0.46	0.58	2.10
R22207	67-05	Edgar	Bt	0.7–0.8	68.40	14.20	6.91	1.02	0.46	0.48	1.99
R22208	67-07	Edgar	BCt	1.0–1.2	74.70	10.70	5.71	0.79	0.44	0.67	2.37
R22209	67-09	Edgar	2C	1.4–1.7	60.70	7.00	3.23	4.37	8.81	0.47	2.47
R22037	22-01	Edwards	A	0.0–0.1	79.53	6.47	2.18	0.46	0.84	0.75	1.63
R22038	22-02	Edwards	A	0.1–0.4	84.82	5.98	2.21	0.34	0.48	0.67	1.64
R22039	22-03	Edwards	A	0.4–0.6	86.20	6.00	1.91	0.19	0.28	0.66	1.62
R22040	22-04	Edwards	A	0.6–0.9	87.12	5.38	2.13	0.17	0.22	0.53	1.47
R22041	22-08	Edwards	C	1.4–1.8	84.04	7.58	1.75	0.33	0.43	1.01	1.64
R22042	22-14	Edwards	C	2.9–3.1	84.38	6.74	3.02	0.38	0.33	0.59	1.37
R22049	24-01	Edwards	A	0.0–0.2	81.73	7.27	2.50	0.32	0.38	0.78	1.88
R22050	24-02	Edwards	A	0.2–0.4	79.83	9.12	3.14	0.45	0.36	0.75	2.03
R22051	24-03	Edwards	B	0.4–0.5	74.58	11.65	4.83	0.80	0.45	0.70	2.10
R22052	24-04	Edwards	B	0.5–0.6	73.50	12.20	5.14	0.89	0.43	0.83	2.15
R22053	24-10	Edwards	C	1.8–2.2	80.94	8.97	3.29	0.46	0.34	0.63	1.45
R22054	24-16	Edwards	2B	2.8–3.0	81.93	9.07	3.28	0.40	0.23	0.43	1.38
R22185	39-1/2	Effingham	A	0.0–0.3	81.20	7.30	3.12	0.46	0.49	0.85	1.57
R22186	39-03	Effingham	E	0.3–0.4	72.20	12.30	5.03	0.86	0.26	0.77	1.62
R22187	39-04	Effingham	B1	0.4–0.8	71.30	13.50	5.59	1.00	0.30	0.80	1.82
R22188	39-05	Effingham	B2	0.8–0.9	75.30	10.50	5.00	0.88	0.36	1.03	2.09
R22189	39-07	Effingham	2B1	1.0–1.3	79.80	9.20	3.74	0.51	0.38	0.81	1.54
R22190	39-13	Effingham	3Bt4	2.7–2.9	70.00	11.10	9.77	0.70	0.47	0.57	1.60
R22116	30-01	Fayette	Ap	0.0–0.2	81.10	7.70	2.52	0.32	0.50	0.90	1.64
R22117	30-02	Fayette	AE	0.2–0.4	79.30	9.50	3.23	0.51	0.35	0.95	1.86
R22118	30-03	Fayette	E	0.4–0.5	74.90	11.30	4.61	0.77	0.32	0.97	1.93
R22119	30-04	Fayette	B1	0.5–0.9	72.90	13.00	4.81	0.93	0.40	0.97	1.87
R22120	30-08	Fayette	2B	1.6–1.8	84.10	7.50	1.97	0.33	0.38	0.62	1.26
R22121	31-01	Fayette	Ap	0.0–0.1	76.50	10.60	3.31	0.52	0.56	0.71	1.43
R22122	31-02	Fayette	Bt1	0.1–0.4	74.20	12.90	4.09	0.72	0.59	0.71	1.38
R22123	31-03	Fayette	Bt2	0.4–0.7	77.70	10.70	4.02	0.70	0.68	0.74	1.40
R22124	31-04	Fayette	Bt3	0.7–1.1	78.50	8.00	7.26	0.57	0.57	0.67	1.48
R22125	31-08	Fayette	B7	1.1–2.0	81.80	8.00	2.19	0.59	1.32	0.88	1.83
R22126	31-20	Fayette	0.08	3.8–4.9	67.20	9.00	2.74	2.96	5.17	0.91	1.80
R22191	40-01	Fayette	Ap	0.0–0.1	76.50	7.50	4.17	0.38	0.53	0.83	1.67
R22192	40-02	Fayette	E	0.1–0.4	80.90	8.30	3.08	0.40	0.30	0.90	1.74
R22193	40-03	Fayette	B1	0.4–0.5	76.30	10.80	4.36	0.64	0.29	0.91	1.92
R22194	40-04	Fayette	B2	0.5–0.7	74.70	11.80	4.89	0.80	0.24	0.87	1.79
R22195	40-07	Fayette	2B1	1.0–1.2	72.20	12.60	5.88	0.96	0.36	1.00	2.02
R22196	40-14	Fayette	3Bt1	2.8–3.1	77.80	10.80	3.73	0.69	0.42	0.66	1.56
R22197	41-01	Fayette	Ap	0.0–0.3	78.90	7.60	3.91	0.37	0.60	0.95	1.69
R22198	41-02	Fayette	E1	0.3–0.4	77.60	8.80	3.98	0.45	0.44	0.94	1.79
R22199	41-03	Fayette	E2	0.4–0.5	75.00	10.90	4.59	0.66	0.38	0.95	1.85
R22200	41-04	Fayette	EB	0.5–0.7	72.00	12.80	4.87	0.87	0.34	0.91	1.68
R22201	41-09	Fayette	C1	1.8–2.4	81.60	8.50	2.60	0.47	0.48	0.97	1.62
R22202	41-23	Fayette	3C2	5.2–5.5	60.20	13.20	2.66	3.58	6.04	0.88	1.89

Continued on next page

Electronic Filing: Received, Clerk's Office 3/24/2022

Lab no.	Sample ID	County	Horizon	Depth interval (m)	SiO <sub>2</sub> (%)	Al <sub>2</sub> O <sub>3</sub> (%)	Fe <sub>2</sub> O <sub>3</sub> (%)	MgO (%)	CaO (%)	Na <sub>2</sub> O (%)	K <sub>2</sub> O (%)
R23071	89-01	Ford	Ap	0.0–0.3	72.88	10.88	3.02	0.79	1.27	0.80	2.09
R23072	89-02	Ford	Bg1	0.3–0.5	73.95	12.96	3.41	0.85	0.82	0.80	2.10
R23073	89-03	Ford	Bgt21	0.5–0.6	69.45	15.33	5.17	1.20	0.92	0.65	1.98
R23074	89-04	Ford	Bgt22	0.6–0.9	71.40	14.51	4.28	1.22	1.04	0.81	2.11
R23075	89-05	Ford	2Bg3	0.9–1.0	82.67	8.46	2.49	0.65	0.87	0.79	1.92
R23076	89-07	Ford	2C	1.1–1.3	77.13	6.39	2.93	2.03	2.92	0.58	1.82
R22127	11-01	Franklin	Ap	0.0–0.2	81.40	8.00	2.67	0.28	0.44	0.99	1.74
R22128	11-02	Franklin	AE	0.2–0.4	81.80	8.30	2.30	0.30	0.40	1.00	1.70
R22129	11-03	Franklin	AE	0.4–0.6	82.40	7.90	2.20	0.26	0.32	0.99	1.66
R22130	11-05	Franklin	B	0.9–1.1	81.70	8.30	2.23	0.24	0.26	0.95	1.55
R22131	11-06	Franklin	B	1.6–1.7	82.00	8.90	2.20	0.32	0.31	1.01	1.63
R22132	11-34	Franklin	C	6.8–6.9	82.30	7.60	2.25	0.54	0.58	1.09	1.75
R23011	79-01	Fulton	Ap	0.0–0.2	79.59	7.71	2.33	0.46	0.50	1.22	2.12
R23012	79-02	Fulton	E	0.2–0.3	79.94	8.87	2.68	0.57	0.44	1.24	2.24
R23013	79-03	Fulton	BE	0.3–0.4	73.78	12.28	4.24	0.99	0.51	1.02	2.22
R23014	79-04	Fulton	Bt	0.4–0.6	69.76	14.64	5.10	1.32	0.55	0.95	2.08
R23015	79-06	Fulton	Bt2	0.8–1.1	71.37	13.52	5.17	1.19	0.52	1.13	2.23
R23016	79-11	Fulton	C	1.6–1.8	62.34	10.02	3.26	4.58	5.75	1.25	2.04
R23041	84-01	Fulton	Ap	0.0–0.2	76.95	10.46	2.80	0.75	0.89	1.10	2.13
R23042	84-02	Fulton	Btj	0.2–0.4	73.20	12.37	4.62	1.08	0.85	0.97	2.17
R23043	84-03	Fulton	Bt	0.4–0.6	74.02	11.89	4.65	1.05	0.80	0.99	2.12
R23044	84-05	Fulton	Bt	0.8–1.0	75.21	11.60	4.08	0.98	0.85	1.09	2.14
R23045	84-09	Fulton	2Bw	1.4–1.7	87.53	6.27	1.53	0.41	0.58	0.57	1.43
R23046	84-14	Fulton	2C	2.3–2.4	85.32	7.25	1.90	0.47	0.63	0.73	1.65
R23047	85-01	Fulton	Ap	0.0–0.1	75.80	11.39	3.38	0.65	0.83	0.94	2.27
R23048	85-02	Fulton	Bt	0.1–0.4	72.73	13.23	4.49	0.90	0.84	0.89	2.21
R23049	85-03	Fulton	Bt	0.4–0.6	71.50	13.50	5.24	0.98	0.83	0.83	2.18
R23050	85-05	Fulton	Bt	0.8–1.0	71.52	13.55	5.12	1.04	0.89	0.93	2.13
R23051	85-09	Fulton	CBt	1.7–1.9	74.84	11.53	4.31	0.88	0.95	0.96	2.42
R23052	85-13	Fulton	C	2.3–2.5	62.75	9.95	3.38	3.92	5.62	0.95	2.20
R22228	46-01	Greene	Ap	0.0–0.2	78.10	8.90	2.48	0.49	0.83	1.09	2.11
R22229	46-02	Greene	A	0.2–0.4	78.20	9.00	2.53	0.52	0.81	1.09	2.12
R22230	46-04	Greene	AB	0.6–0.7	75.90	10.50	3.45	0.75	0.83	1.07	2.07
R22231	46-05	Greene	B/Ab	0.7–0.9	73.50	12.00	4.22	0.98	0.87	1.01	2.02
R22232	46-08	Greene	Bg	1.2–1.5	73.20	12.10	5.07	1.11	0.86	1.08	2.18
R22233	46-33	Greene	2DC	5.7–5.9	81.00	8.30	2.90	0.73	0.46	0.84	2.41
R23190	103-1	Grundy	Ap	0.0–0.2	68.12	10.75	3.84	1.34	1.99	0.83	2.03
R23191	103-2	Grundy	A	0.2–0.5	69.80	11.97	4.07	1.32	1.47	0.90	1.98
R23192	103-3	Grundy	BA	0.5–0.6	71.62	12.46	4.44	1.40	1.28	0.98	2.02
R23193	103-4	Grundy	Btj	0.6–0.7	53.87	6.83	3.11	6.72	9.72	0.63	1.50
R23194	103-5	Grundy	Ctj	0.7–0.9	68.73	11.79	4.49	2.28	2.58	0.95	1.96
R22133	12-02	Hamilton	Ap	0.1–0.2	73.00	11.30	4.61	0.91	0.81	0.91	2.43
R22134	12-03	Hamilton	B	0.2–0.4	70.60	12.60	5.25	1.13	0.78	0.81	2.49
R22135	12-04	Hamilton	B	0.4–0.6	69.20	12.60	5.33	1.18	0.75	0.80	2.47
R22136	12-06	Hamilton	B	0.9–1.0	71.50	13.40	5.67	1.30	0.78	0.84	2.57
R22137	12-19	Hamilton	2B	2.8–3.1	76.70	11.40	3.61	0.78	0.77	1.13	2.13
R22203	12-27	Hamilton	3C	6.7–6.9	61.60	13.50	4.89	1.93	5.48	0.80	2.26
R23023	81-01	Hancock	A	0.0–0.2	71.97	10.03	2.74	0.82	2.67	1.13	1.74
R23024	81-02	Hancock	AB	0.2–0.6	73.11	12.61	3.58	0.73	0.68	1.21	1.75
R23025	81-03	Hancock	Bt	0.6–0.7	66.92	16.76	5.38	1.09	0.72	1.10	1.76
R23026	81-05	Hancock	Btg	0.9–1.1	72.39	15.64	3.65	0.78	0.54	0.73	1.09
R23027	81-07	Hancock	Btg	1.3–1.5	71.45	16.52	3.83	0.82	0.58	0.60	1.06
R23028	81-13	Hancock	Btox	2.2–2.4	70.61	14.05	7.39	0.69	0.41	0.68	1.42
R23029	82-01	Hancock	A	0.0–0.2	74.48	10.09	2.66	0.71	1.12	1.11	2.06
R23030	82-02	Hancock	AB	0.2–0.4	72.54	12.74	4.38	1.02	0.86	1.06	2.11
R23031	82-03	Hancock	Bt	0.4–0.6	76.07	10.52	2.84	0.72	0.86	1.10	2.09
R23032	82-04	Hancock	Bt	0.6–1.0	71.32	13.28	4.81	1.28	1.00	1.10	2.16

Continued on next page



Electronic Filing: Received, Clerk's Office 3/24/2022

Lab no.	Sample ID	County	Horizon	Depth interval (m)	SiO <sub>2</sub> (%)	Al <sub>2</sub> O <sub>3</sub> (%)	Fe <sub>2</sub> O <sub>3</sub> (%)	MgO (%)	CaO (%)	Na <sub>2</sub> O (%)	K <sub>2</sub> O (%)
R23033	82-09	Hancock	CBgt	1.7-1.9	72.26	12.56	4.58	1.32	1.33	1.46	2.27
R23034	82-13	Hancock	Cgtj	2.4-2.7	69.67	10.47	2.94	2.77	3.60	1.42	2.05
R23344	107-1	Henry	Ap	0.0-0.2	70.84	12.70	4.74	1.25	0.95	0.92	2.13
R23345	107-2	Henry	Bt1	0.2-0.3	73.62	11.28	4.99	1.26	0.95	0.94	2.22
R23346	107-3	Henry	Bt2	0.3-0.6	74.59	11.13	4.61	1.20	0.97	1.08	2.23
R23347	107-4	Henry	Bt3	0.6-0.7	74.70	10.98	4.52	1.21	1.06	1.16	2.46
R23348	107-6	Henry	2Ab	0.8-0.9	76.17	10.45	4.03	1.12	1.05	1.17	2.20
R23349	107-9	Henry	3BtA	1.2-1.4	72.94	12.11	5.50	1.28	0.81	0.55	1.96
R23350	108-1	Henry	Ap	0.0-0.2	69.69	10.55	3.86	1.15	1.30	0.90	2.03
R23351	108-2	Henry	A2	0.2-0.4	69.84	11.64	4.65	1.19	1.13	0.90	2.03
R23352	108-3	Henry	Bt	0.4-0.6	69.75	12.63	5.32	1.35	1.09	0.85	2.04
R23353	108-5	Henry	Bt	0.8-1.0	72.19	12.43	4.97	1.43	1.12	1.01	2.12
R23354	108-7	Henry	BCtj	1.2-1.4	74.78	11.42	4.13	1.28	1.23	1.20	2.10
R23355	108-10	Henry	C21	1.8-2.0	64.27	9.07	2.67	3.72	6.32	1.04	1.92
R23390	110-1	Henry	Ap	0.0-0.2	82.22	6.99	2.43	0.85	0.97	0.88	1.93
R23391	110-2	Henry	Btj	0.2-0.3	80.18	8.23	3.65	0.98	0.87	0.74	1.79
R23392	110-3	Henry	Bt	0.3-0.5	79.50	8.72	3.89	1.02	0.90	0.76	1.80
R23393	110-5	Henry	Bt	0.7-0.8	83.38	7.10	2.86	0.87	0.91	0.89	1.75
R23394	110-7	Henry	E	0.9-1.0	87.58	5.50	1.62	0.70	0.87	1.00	1.53
R23395	110-9	Henry	C	1.2-1.4	88.80	5.06	1.38	0.70	0.90	0.93	1.36
R23396	111-1	Henry	Ap	0.0-0.3	78.54	7.92	3.00	0.94	1.26	0.84	1.62
R23397	111-2	Henry	A12	0.3-0.4	79.88	7.68	3.49	0.93	1.18	0.83	1.59
R23398	111-3	Henry	A13	0.4-0.6	79.92	8.39	3.16	0.99	1.28	0.88	1.66
R23399	111-4	Henry	BA	0.6-0.8	78.32	8.13	5.13	1.05	1.27	0.92	1.69
R23400	111-5	Henry	AB	0.8-1.0	81.39	6.78	2.35	1.31	1.77	0.80	1.53
R23401	111-6	Henry	C1	1.0-1.1	83.81	3.96	1.13	1.92	2.78	0.52	1.16
R23135	97-01	Iroquois	Ap	0.0-0.2	72.97	10.73	3.21	1.30	1.24	0.89	2.66
R23136	97-02	Iroquois	A2	0.2-0.3	73.66	11.10	3.23	1.32	1.15	0.90	2.69
R23137	97-03	Iroquois	Bg	0.3-0.6	73.18	10.87	3.92	1.91	1.96	0.89	2.71
R23138	97-05	Iroquois	Bg	0.6-0.7	73.54	11.16	3.93	1.34	1.06	0.89	2.75
R23139	97-07	Iroquois	C	0.6-1.0	55.25	11.47	5.68	4.69	6.15	0.62	3.44
R23140	97-09	Iroquois	C	1.3-1.5	53.48	10.85	4.97	4.94	7.73	0.67	3.24
R23147	99-01	Iroquois	Ap	0.0-0.2	85.61	5.68	1.44	0.65	0.70	0.79	1.41
R23148	99-02	Iroquois	BA	0.2-0.4	86.77	6.02	1.49	0.66	0.69	0.75	1.49
R23149	99-03	Iroquois	Bw	0.4-0.6	87.76	5.78	1.34	0.65	0.66	0.80	1.56
R23150	99-06	Iroquois	Bg	0.6-0.8	86.01	6.77	1.67	0.71	0.76	0.90	1.72
R23152	99-08	Iroquois	CBg	0.8-1.1	88.70	5.39	1.22	0.67	0.80	0.94	1.63
R23153	99-09	Iroquois	Cg	1.3-1.5	88.57	5.46	1.17	0.70	0.87	0.97	1.71
R23153	100-01	Iroquois	Ap	0.0-0.2	74.28	9.72	3.96	1.10	0.92	0.76	2.51
R23154	100-02	Iroquois	BAt	0.2-0.4	70.25	12.55	5.38	1.43	0.79	0.64	3.07
R23155	100-03	Iroquois	Bt	0.4-0.6	69.75	12.62	5.92	1.54	0.73	0.64	3.46
R23156	100-05	Iroquois	B3t	0.8-1.0	58.41	9.65	4.25	4.61	6.73	0.59	3.09
R23157	100-06	Iroquois	C	1.2-1.4	52.99	8.78	3.70	5.43	9.85	0.58	2.95
R23158	100-08	Iroquois	C	1.8-2.0	54.08	8.94	3.75	5.58	8.94	0.56	3.05
R23159	101-01	Iroquois	Ap	0.0-0.3	68.57	12.51	4.62	1.56	1.16	0.68	2.66
R23160	101-02	Iroquois	BA	0.3-0.4	64.28	16.23	5.97	1.83	0.89	0.64	2.83
R23161	101-03	Iroquois	Bgtj	0.4-0.6	63.29	17.29	6.29	2.11	0.87	0.63	3.16
R23162	101-04	Iroquois	Bgt	0.9-1.1	56.93	17.08	6.20	3.69	2.52	0.45	4.53
R23163	101-05	Iroquois	Cgtj	1.3-1.5	55.24	15.82	5.67	4.03	4.18	0.53	4.28
R23164	101-07	Iroquois	Cg	1.5-1.7	51.76	15.61	5.34	4.66	5.45	0.45	4.75
R21838	8-01	Jackson	B	0.0-0.3	53.40	7.90	3.09	1.11	12.11	0.58	1.54
R21839	8-02	Jackson	C	0.3-0.4	72.10	8.60	3.03	0.57	3.29	0.88	1.86
R21840	8-03	Jackson	C	0.4-0.5	79.00	9.10	3.15	0.50	0.67	0.95	1.92
R21841	8-06	Jackson	2B	1.0-1.2	81.00	8.50	2.03	0.44	0.52	1.09	2.05
R21893	8-12	Jackson	3A	2.4-2.7	79.00	8.30	4.81	0.57	0.63	0.87	1.64
R21894	8-22	Jackson	4C	4.1-4.2	76.30	10.90	3.47	0.90	1.07	1.39	2.24
R22179	38-01	Jasper	Ap	0.0-0.2	79.00	8.20	2.56	0.39	1.32	1.09	1.72

Continued on next page

Electronic Filing: Received, Clerk's Office 3/24/2022

Lab no.	Sample ID	County	Horizon	Depth interval (m)	SiO <sub>2</sub> (%)	Al <sub>2</sub> O <sub>3</sub> (%)	Fe <sub>2</sub> O <sub>3</sub> (%)	MgO (%)	CaO (%)	Na <sub>2</sub> O (%)	K <sub>2</sub> O (%)
R22180	38-02	Jasper	AE	0.2-0.4	80.00	8.90	2.85	0.40	0.48	1.08	1.76
R22181	38-03	Jasper	E	0.4-0.6	80.90	8.10	3.14	0.39	0.34	0.95	1.77
R22182	38-05	Jasper	Bt1	0.6-0.9	66.20	16.20	6.36	1.27	0.44	0.69	1.73
R22183	38-08	Jasper	2A1	1.5-1.9	80.40	9.50	3.12	0.53	0.47	0.78	1.48
R22184	38-13	Jasper	2Bt4	3.7-3.8	77.90	10.80	3.53	0.80	0.52	0.68	1.99
R22061	26-01	Jefferson	A	0.0-0.2	83.06	6.76	1.74	0.28	0.75	0.92	1.56
R22062	26-02	Jefferson	A	0.2-0.5	83.62	7.36	2.22	0.27	0.39	0.85	1.50
R22063	26-03	Jefferson	E	0.5-0.6	82.68	7.91	2.69	0.29	0.33	0.86	1.53
R22064	26-04	Jefferson	B	0.6-0.9	83.64	7.27	2.79	0.24	0.30	0.83	1.49
R22065	26-08	Jefferson	2C	1.5-1.7	75.66	11.89	3.75	0.59	0.36	0.71	1.58
R22066	26-15	Jefferson	2D	2.4-2.8	60.20	19.94	6.07	1.36	0.33	0.66	3.33
R22216	44-01	Jersey	Ap	0.0-0.3	81.50	7.80	2.27	0.38	0.67	1.23	2.05
R22217	44-02	Jersey	EB	0.3-0.5	78.40	9.50	3.40	0.60	0.60	1.20	2.10
R22218	44-03	Jersey	B	0.5-0.6	71.60	13.20	5.22	1.04	0.64	0.92	2.00
R22219	44-04	Jersey	Btj	0.6-0.9	71.70	13.00	5.36	1.04	0.62	0.93	2.06
R22220	44-13	Jersey	2AB	2.4-2.7	78.20	10.80	2.86	0.59	0.70	1.05	1.89
R22221	44-29	Jersey	2C	5.4-5.5	60.80	7.10	2.43	4.63	9.69	0.60	2.07
R23461	119-1	Jo Daviess	Ap	0.0-0.2	74.65	10.34	2.64	1.14	1.45	1.20	1.93
R23462	119-2	Jo Daviess	Ap	0.2-0.4	74.69	11.28	2.96	1.00	1.18	1.21	1.96
R23463	119-3	Jo Daviess	BA	0.4-0.6	72.43	12.88	3.97	1.16	1.16	1.20	2.00
R23464	119-5	Jo Daviess	Bt	0.7-0.9	70.87	14.29	4.41	1.33	1.28	1.17	2.06
R23465	119-6	Jo Daviess	Bt	0.9-1.0	71.89	14.06	3.79	1.32	1.29	1.22	2.32
R23466	119-11	Jo Daviess	2Cr	1.6-1.9	45.68	18.95	5.03	5.12	6.17	0.22	4.82
R23467	120-1	Jo Daviess	Ap	0.0-0.1	68.36	13.07	3.57	1.73	1.99	0.98	2.16
R23468	120-2	Jo Daviess	Bt	0.1-0.3	68.98	14.70	3.98	1.51	1.39	0.96	2.12
R23469	120-4	Jo Daviess	Bt	0.4-0.6	68.77	16.08	4.75	1.44	0.99	1.02	2.11
R23470	120-5	Jo Daviess	Btg	0.6-0.8	68.09	16.33	4.87	1.47	1.07	1.11	2.14
R23471	120-8	Jo Daviess	C	0.9-1.0	69.95	15.43	4.35	1.34	1.18	1.16	2.65
R23472	120-15	Jo Daviess	2Ab	1.4-1.6	69.36	15.80	4.39	1.30	1.08	0.94	2.50
R21766	3-01	Johnson	Ap	0.0-0.2	78.60	8.40	2.98	0.42	0.60	0.93	1.80
R21767	3-02	Johnson	B	0.2-0.4	78.20	9.70	3.30	0.49	0.52	0.94	1.90
R21768	3-03	Johnson	B	0.4-0.6	77.50	10.00	3.77	0.56	0.44	0.95	1.92
R21769	3-04	Johnson	B	0.6-0.9	77.10	10.90	4.20	0.69	0.32	0.91	1.97
R21770	3-05	Johnson	B	0.9-1.3	71.70	13.00	5.54	0.95	0.36	0.89	1.98
R21771	3-10	Johnson	B	2.0-2.2	75.00	11.40	3.76	0.84	0.97	1.23	2.26
R21772	3-14	Johnson	B	3.0-3.6	59.60	21.10	6.05	1.96	1.16	0.21	1.88
R23768	133-1	Kane	Ap	0.0-0.3	76.86	9.56	3.01	0.99	0.99	0.82	2.69
R23769	133-2	Kane	Btj	0.3-0.5	73.48	11.65	4.79	1.23	0.95	0.78	2.75
R23770	133-3	Kane	2Bt	0.5-0.6	74.33	11.21	4.65	1.22	1.02	0.83	2.81
R23771	133-4	Kane	2BC	0.6-0.7	75.62	10.66	4.15	1.19	1.15	0.88	2.87
R23772	133-5	Kane	2C1	0.8-1.0	59.08	7.81	2.66	5.35	7.46	0.72	2.26
R23773	133-6	Kane	2C2	1.0-1.2	56.81	6.96	2.29	6.06	8.67	0.69	2.15
R23790	135-1	Kane	Ap	0.0-0.3	72.36	11.32	3.94	1.14	1.03	0.80	2.25
R23791	135-2	Kane	Btj	0.3-0.5	69.01	13.36	5.92	1.48	0.93	0.60	2.49
R23792	135-3	Kane	Btj	0.5-0.6	70.01	12.42	6.38	1.49	0.85	0.57	2.89
R23793	135-4	Kane	2Bt	0.6-0.7	63.86	14.46	8.28	1.82	0.97	0.46	3.42
R23794	135-5	Kane	2CB	0.7-0.9	49.29	10.11	6.15	6.05	7.71	0.40	3.07
R23795	135-6	Kane	2C	0.9-1.2	40.21	7.44	4.06	8.98	12.30	0.33	2.37
R23141	98-01	Kankakee	Ap	0.0-0.2	75.62	8.32	3.68	1.07	1.18	0.70	2.05
R23142	98-02	Kankakee	Bt	0.2-0.4	67.15	8.62	12.66	1.33	1.11	0.51	2.19
R23143	98-03	Kankakee	Ab	0.4-0.6	74.56	7.40	3.65	1.61	2.01	0.63	1.80
R23144	98-05	Kankakee	Bt	0.6-0.7	76.34	7.90	7.48	1.04	0.68	0.50	2.05
R23145	98-06	Kankakee	Bt	0.7-0.9	66.28	7.20	16.40	0.97	0.65	0.47	1.94
R23146	98-07	Kankakee	Cr	0.9-1.1	28.44	4.07	2.23	13.71	19.12	0.16	1.70
R23165	102-1	Kankakee	A	0.0-0.2	81.21	7.51	2.21	0.78	0.74	0.71	1.73
R23166	102-2	Kankakee	E	0.2-0.5	83.74	7.12	1.94	0.76	0.73	0.73	1.69
R23167	102-3	Kankakee	Bt	0.5-0.6	81.63	8.27	2.45	0.89	0.75	0.70	1.68

Continued on next page

# Electronic Filing: Received, Clerk's Office 3/24/2022

Lab no.	Sample ID	County	Horizon	Depth interval (m)	SiO <sub>2</sub> (%)	Al <sub>2</sub> O <sub>3</sub> (%)	Fe <sub>2</sub> O <sub>3</sub> (%)	MgO (%)	CaO (%)	Na <sub>2</sub> O (%)	K <sub>2</sub> O (%)
R23168	102-4	Kankakee	Bt	0.6–0.8	77.28	10.38	3.58	1.08	0.81	0.62	1.67
R23169	102-5	Kankakee	Btfr	0.8–1.0	73.67	10.83	4.59	1.38	1.16	0.52	1.85
R23170	102-6	Kankakee	Cr	1.0–1.2	57.42	5.20	1.82	6.85	9.91	0.47	1.37
R23796	136-1	Kendall	Ap1	0.0–0.2	71.56	9.88	3.45	1.03	1.95	0.82	2.18
R23797	136-4	Kendall	Btj	0.5–0.6	70.44	13.09	5.11	1.41	1.99	0.79	2.29
R23798	136-6	Kendall	Btj	0.8–0.9	70.75	12.87	5.60	1.38	1.26	0.83	2.45
R23799	136-8	Kendall	2Bt	1.1–1.4	77.57	9.35	4.45	1.20	0.84	0.68	2.27
R23800	136-9	Kendall	2C1	1.4–1.5	54.77	7.66	3.53	6.24	0.62	0.50	2.25
R23801	136-10	Kendall	2C2	1.5–1.7	45.43	7.17	3.45	7.96	0.52	0.43	2.21
R23083	91-01	Knox	Ap1	0.0–0.2	74.26	10.77	3.19	0.67	1.09	0.93	1.99
R23084	91-02	Knox	Ap2	0.2–0.4	73.59	10.97	3.41	0.70	0.97	0.95	1.99
R23085	91-03	Knox	BA	0.4–0.6	71.65	11.79	4.24	0.86	0.90	0.87	2.01
R23086	91-05	Knox	Btj	0.8–1.0	70.08	14.10	5.04	1.06	0.90	0.86	2.06
R23087	91-07	Knox	CBtj	1.1–1.3	73.74	11.93	4.39	1.00	1.07	1.04	2.12
R23088	91-11	Knox	C	1.9–2.1	69.65	10.75	3.52	2.39	3.16	1.04	2.10
R23756	131-1	Lake	A+C1	0.0–0.1	58.92	10.50	4.84	3.81	5.35	0.56	2.95
R23757	131-3	Lake	C3	0.3–0.5	60.25	14.28	7.18	2.98	2.32	0.44	3.46
R23758	131-4	Lake	2CB	0.5–0.6	50.91	12.31	5.28	5.58	6.99	0.38	3.51
R23759	131-5	Lake	2C	0.6–0.8	43.86	10.89	4.33	6.22	11.75	0.31	3.23
R23760	131-6	Lake	2C	0.8–1.0	44.79	10.99	4.50	6.29	11.05	0.36	3.32
R23761	131-7	Lake	2C	1.0–1.2	44.68	10.64	4.39	6.44	11.26	0.38	3.30
R23195	104-1	LaSalle	Ap	0.0–0.3	70.85	10.85	3.26	1.31	1.88	1.00	1.98
R23196	104-2	LaSalle	AB	0.3–0.5	71.30	12.81	3.64	1.14	1.17	0.99	1.96
R23197	104-3	LaSalle	Bt	0.5–0.6	68.28	15.80	4.56	1.41	1.12	0.88	1.92
R23198	104-4	LaSalle	Bt	0.6–0.8	68.09	15.69	5.32	1.45	1.17	0.99	2.01
R23199	104-6	LaSalle	C	0.9–1.1	61.27	11.78	3.74	3.93	5.33	1.00	2.05
R23200	104-8	LaSalle	C	1.2–1.5	54.14	11.03	3.43	4.81	8.80	0.79	2.17
R23414	114-1	LaSalle	Ap	0.0–0.2	70.55	11.28	3.27	1.17	1.43	0.99	2.10
R23415	114-2	LaSalle	A2	0.2–0.4	70.29	13.37	4.30	1.22	1.10	0.96	2.09
R23416	114-3	LaSalle	Bt	0.4–0.6	68.69	14.92	5.19	1.37	1.07	0.97	2.19
R23417	114-4	LaSalle	Bt	0.6–0.8	69.58	14.78	4.82	1.38	1.16	1.13	2.34
R23418	114-5	LaSalle	Btj	0.8–1.0	69.88	13.97	4.44	1.62	1.59	1.18	2.43
R23419	114-6	LaSalle	Ctj	1.0–1.2	60.71	11.78	3.59	3.88	5.56	1.07	2.21
R22150	34-01	Lawrence	Ap	0.0–0.2	80.90	7.20	1.90	0.31	0.55	0.94	1.95
R22151	34-02	Lawrence	A2	0.2–0.3	82.30	7.50	1.95	0.33	0.42	0.95	2.02
R22152	34-03	Lawrence	E	0.3–0.4	81.10	8.30	2.59	0.43	0.38	0.93	2.12
R22153	34-04	Lawrence	B1	0.4–0.5	77.10	10.30	3.79	0.71	0.36	0.92	2.14
R22154	34-10	Lawrence	2Btx4	1.2–1.5	82.00	7.90	2.99	0.49	0.41	0.88	1.71
R22155	34-13	Lawrence	3A	1.8–2.0	85.10	6.50	2.66	0.34	0.28	0.49	1.41
R23437	115-1	Lee	Ap	0.0–0.3	65.60	9.66	3.18	1.82	2.94	1.01	1.97
R23438	115-2	Lee	AB	0.3–0.6	68.09	10.07	3.26	2.08	3.82	1.07	1.93
R23439	115-3	Lee	BAG	0.6–0.7	65.97	9.81	4.91	1.98	5.15	1.05	1.87
R23440	115-5	Lee	Cg	0.9–1.1	58.74	9.34	7.78	2.87	6.77	0.98	1.91
R23441	115-7	Lee	Cg	1.2–1.4	59.98	8.59	3.13	4.38	8.24	1.01	1.97
R23442	115-9	Lee	Cg	1.5–1.7	61.47	7.07	3.55	4.41	7.63	0.95	1.87
R23443	116-1	Lee	Ap	0.0–0.2	82.57	6.83	2.18	0.85	0.88	0.61	1.50
R23444	116-3	Lee	Btj	0.3–0.5	82.03	7.84	2.57	0.89	0.76	0.59	1.48
R23445	116-4	Lee	Btj	0.5–0.6	81.70	8.21	2.84	0.96	0.76	0.59	1.44
R23446	116-5	Lee	Btj	0.6–0.8	85.72	6.36	2.23	0.84	0.67	0.48	1.19
R23447	116-6	Lee	BC	0.8–0.9	89.48	4.85	1.43	0.69	0.61	0.39	1.02
R23448	116-9	Lee	C	1.1–1.3	92.61	3.49	0.83	0.60	0.56	0.30	0.81
R23123	95-01	Livingston	Ap	0.0–0.3	71.97	12.39	3.17	0.84	1.36	0.81	2.00
R23124	95-02	Livingston	A	0.3–0.5	72.02	13.04	3.42	0.76	1.05	0.76	2.00
R23125	95-03	Livingston	Bgtj	0.5–0.6	69.25	15.81	4.82	1.06	0.97	0.72	1.92
R23126	95-05	Livingston	Bgt2	0.8–0.9	69.17	16.02	5.05	1.16	1.04	0.83	2.04
R23127	95-08	Livingston	2Cgt1	1.2–1.4	67.44	11.10	3.66	2.90	3.57	0.76	2.49

*Continued on next page*



Electronic Filing: Received, Clerk's Office 3/24/2022

Lab no.	Sample ID	County	Horizon	Depth interval (m)	SiO <sub>2</sub> (%)	Al <sub>2</sub> O <sub>3</sub> (%)	Fe <sub>2</sub> O <sub>3</sub> (%)	MgO (%)	CaO (%)	Na <sub>2</sub> O (%)	K <sub>2</sub> O (%)
R23128	95-13	Livingston	3Cg	2.0-2.3	50.78	13.65	4.55	5.50	6.89	0.38	3.92
R23129	96-01	Livingston	Ap	0.0-0.3	64.90	14.19	5.01	1.31	2.14	0.67	2.65
R23130	96-02	Livingston	Bgt	0.3-0.5	63.81	15.07	8.22	1.69	1.13	0.50	3.05
R23131	96-03	Livingston	2CBtj	0.5-0.6	47.85	10.34	5.29	6.85	8.57	0.27	2.86
R23132	96-04	Livingston	2CBtj	0.6-0.9	54.24	11.10	5.68	5.08	6.23	0.38	3.31
R23133	96-07	Livingston	2C	1.1-1.4	50.96	13.88	4.78	4.96	7.06	0.39	3.91
R23134	96-11	Livingston	4C	2.0-2.3	50.32	13.98	5.64	4.66	6.96	0.41	3.79
R22347	64-01	Logan	Ap	0.0-0.2	75.10	9.40	4.40	0.50	0.75	0.70	2.13
R22348	64-02	Logan	A	0.2-0.5	74.20	9.90	4.82	0.56	0.58	0.67	2.09
R22349	64-03	Logan	Bt1	0.5-0.6	73.00	10.70	5.32	0.75	0.57	0.77	2.16
R22350	64-06	Logan	BC	1.0-1.1	74.50	10.50	4.92	0.96	1.01	0.97	2.27
R22351	64-08	Logan	C	1.2-1.5	62.00	7.50	3.70	4.67	7.07	0.72	2.10
R22352	64-22	Logan	3BAb	4.1-4.3	75.60	10.90	5.53	0.90	0.54	0.53	1.80
R22686	74-01	Logan	Ap	0.0-0.2	68.20	13.00	3.79	1.01	1.37	0.97	2.02
R22687	74-03	Logan	AB	0.3-0.5	69.90	13.70	4.42	1.14	1.04	1.04	2.01
R22688	74-04	Logan	Bg	0.5-0.7	70.90	13.80	4.38	1.15	0.91	1.07	2.06
R22689	74-05	Logan	B	0.7-0.9	69.60	14.50	5.28	1.24	0.88	1.10	2.12
R22690	74-07	Logan	Bgtj	1.0-1.2	69.00	13.40	4.25	1.81	1.78	1.05	2.11
R22691	74-11	Logan	C	1.7-1.8	59.20	8.10	2.47	6.10	7.81	1.00	2.04
R22704	77-1	Logan	Ap	0.0-0.3	69.96	10.87	3.12	0.57	0.56	0.85	1.99
R22705	77-2	Logan	AB	0.3-0.5	66.21	13.65	4.07	0.84	0.46	0.73	1.96
R22706	77-5	Logan	Bt	0.5-1.0	67.87	14.61	4.85	0.92	0.42	0.91	1.98
R22707	77-8	Logan	Bt1	1.3-1.5	71.76	12.54	4.31	0.77	0.59	1.13	2.09
R22708	77-14	Logan	C	2.2-2.4	90.17	5.42	1.05	0.14	0.26	0.72	1.49
R22709	77-26	Logan	Ab	3.9-4.1	72.56	12.28	4.07	0.82	1.07	1.45	2.21
R22692	75-01	Macon	Ap	0.0-0.2	77.20	12.40	3.75	0.71	0.66	0.93	2.00
R22693	75-02	Macon	AB	0.2-0.4	69.50	15.20	4.62	1.05	0.48	0.75	1.82
R22694	75-03	Macon	Btj	0.4-0.6	67.10	17.00	5.65	1.18	0.53	0.69	1.83
R22695	75-04	Macon	Bt	0.6-0.8	68.70	15.80	5.64	1.10	0.52	0.82	1.94
R22696	75-06	Macon	Btj	1.0-1.1	72.50	13.20	4.49	1.18	0.90	0.92	2.30
R22697	75-10	Macon	C	1.6-1.8	61.40	9.50	3.11	4.42	7.02	0.54	2.59
R22210	43-01	Macoupin	Ap	0.0-0.2	82.10	7.60	2.05	0.27	0.56	1.17	1.76
R22211	43-03	Macoupin	E	0.3-0.5	75.50	10.50	4.70	0.59	0.55	1.08	1.81
R22212	43-05	Macoupin	Bt	0.6-0.9	69.70	13.60	6.57	1.06	0.57	0.92	1.82
R22213	43-08	Macoupin	C	1.3-1.5	76.70	10.90	3.05	0.76	0.98	1.55	2.15
R22214	43-12	Macoupin	3A	1.9-2.1	77.90	11.20	2.91	0.71	0.66	0.90	1.74
R22215	43-27	Macoupin	3CD	4.9-5.1	60.70	6.80	1.99	5.01	9.34	0.65	2.04
R22234	47-01	Macoupin	Ap	0.0-0.2	80.90	8.30	2.43	0.48	0.67	1.06	2.04
R22235	47-02	Macoupin	C1	0.2-0.6	80.10	8.70	2.59	0.57	0.73	1.07	2.06
R22236	47-04	Macoupin	C3	0.7-1.1	82.50	7.80	2.25	0.45	0.62	1.00	1.90
R22237	47-05	Macoupin	C4	1.1-1.2	80.10	8.80	2.59	0.60	0.73	1.09	2.08
R22238	47-08	Macoupin	2Bt1	1.8-2.0	81.00	8.70	2.89	0.52	0.55	0.98	1.93
R22239	47-16	Macoupin	2C7	4.3-4.5	78.20	9.90	3.72	0.73	0.65	0.94	2.00
R22104	28-01	Madison	A	0.0-0.3	80.00	8.60	2.25	0.45	0.74	1.09	2.04
R22105	28-02	Madison	B1	0.3-0.7	73.10	12.00	3.51	0.80	0.77	0.92	2.25
R22106	28-03	Madison	B2	0.7-1.1	77.90	10.20	2.55	0.53	0.64	1.05	2.24
R22107	28-04	Madison	B3	1.1-1.4	76.50	11.00	3.78	0.69	0.63	1.05	2.31
R22108	28-10	Madison	C3	2.9-3.1	80.80	9.00	2.59	0.51	0.67	1.14	2.11
R22209	28-15	Madison	D3	4.9-5.1	80.50	9.10	1.80	0.53	0.67	1.13	2.14
R22025	20-01	Marion	A	0.0-0.1	79.29	7.75	2.86	0.40	0.92	0.95	1.66
R22026	20-02	Marion	E	0.1-0.2	80.46	8.44	3.07	0.43	0.30	1.01	1.85
R22027	20-03	Marion	B	0.2-0.4	79.22	8.06	2.54	0.42	0.69	0.98	1.93
R22028	20-04	Marion	B	0.4-0.6	69.67	14.44	5.83	1.21	0.35	0.83	1.80
R22029	20-08	Marion	B	1.3-1.7	80.39	9.17	3.10	0.49	0.48	0.91	1.50
R22030	20-11	Marion	C	2.3-2.4	82.14	8.39	3.02	0.38	0.45	0.86	1.43
R22710	78-01	Mason	Ap	0.0-0.3	89.42	3.80	1.23	0.14	0.18	0.48	1.11
R22711	78-03	Mason	Bt1	0.4-0.6	67.50	14.71	4.28	0.86	0.17	0.44	1.60

Continued on next page

Electronic Filing: Received, Clerk's Office 3/24/2022

Lab no.	Sample ID	County	Horizon	Depth interval (m)	SiO <sub>2</sub> (%)	Al <sub>2</sub> O <sub>3</sub> (%)	Fe <sub>2</sub> O <sub>3</sub> (%)	MgO (%)	CaO (%)	Na <sub>2</sub> O (%)	K <sub>2</sub> O (%)
R22712	78-04	Mason	Bt1	0.6-0.7	75.96	11.12	3.29	0.61	0.13	0.45	1.32
R22713	78-09	Mason	C	1.3-1.4	92.82	3.32	0.71	0.08	0.12	0.47	1.10
R22714	78-12	Mason	b	1.6-1.8	91.08	3.82	1.07	0.14	0.12	0.52	1.08
R22715	78-17	Mason	C	2.7-2.9	78.70	2.50	0.84	1.89	3.97	0.55	0.72
R23017	80-01	McDonough	Ap	0.0-0.2	72.11	7.28	2.65	1.00	5.85	0.99	1.46
R23018	80-04	McDonough	C/A	0.3-0.4	78.03	9.04	2.85	0.82	1.45	1.18	1.72
R23019	80-08	McDonough	CB	0.8-0.9	75.47	8.58	3.14	0.81	3.24	1.03	1.55
R23020	80-10	McDonough	2CB	1.1-1.2	76.06	10.50	3.45	0.91	1.30	1.15	1.80
R23021	80-15	McDonough	4B	1.5-1.6	75.73	12.15	3.08	0.57	0.47	1.04	1.86
R23022	80-20	McDonough	5Ab	2.2-2.4	74.81	11.92	3.65	0.71	0.52	0.97	1.82
R23035	83-01	McDonough	A	0.0-0.2	72.03	11.11	2.92	0.80	1.32	1.03	1.96
R23036	83-02	McDonough	A	0.2-0.4	71.49	11.92	3.34	0.94	1.10	1.03	1.99
R23037	83-04	McDonough	Bgt	0.8-1.0	71.53	13.65	4.28	1.31	1.09	1.02	2.03
R23038	83-05	McDonough	Bgt	1.0-1.2	73.76	12.79	3.40	1.26	1.17	1.22	2.12
R23039	83-10	McDonough	BCtj	2.0-2.1	72.12	10.77	3.92	1.85	2.26	1.27	2.44
R23040	83-14	McDonough	2Ab	2.6-2.8	78.84	11.05	1.82	0.70	0.91	0.96	1.43
R23762	132-1	McHenry	Ap	0.0-0.2	73.83	10.24	3.86	1.10	1.02	0.73	2.17
R23763	132-2	McHenry	Btj	0.2-0.4	73.49	11.48	4.98	1.39	1.01	0.77	2.11
R23764	132-3	McHenry	Btj	0.4-0.6	70.66	12.77	5.29	1.45	1.00	0.71	2.02
R23765	132-4	McHenry	2Bt	0.6-0.7	75.34	10.29	4.66	1.37	1.08	0.68	2.62
R23766	132-5	McHenry	2CB	0.7-0.9	58.84	7.27	2.72	5.66	7.70	0.57	2.16
R23767	132-6	McHenry	2C1	0.9-1.0	52.04	6.81	2.54	6.95	10.12	0.67	2.09
R22674	72-01	McLean	Ap	0.0-0.3	72.10	11.30	3.33	0.74	0.80	0.95	2.10
R22675	72-02	McLean	AB	0.3-0.5	70.20	14.20	4.33	1.08	0.70	0.88	2.15
R22676	72-03	McLean	Bg	0.5-0.6	69.60	15.10	4.74	1.24	0.72	0.90	2.13
R22677	72-04	McLean	Bg	0.6-0.9	69.70	14.40	5.42	1.24	0.73	0.99	2.23
R22678	72-06	McLean	Bg	1.0-1.2	71.30	13.50	5.02	1.19	0.72	1.00	2.47
R22679	72-09	McLean	2C	1.7-2.0	69.20	11.20	3.71	2.78	2.71	0.66	2.79
R22680	73-01	McLean	Ap	0.0-0.2	73.70	11.50	3.26	0.64	0.67	0.94	2.01
R22681	73-02	McLean	AB	0.2-0.4	69.60	15.00	4.59	0.98	0.56	0.77	1.98
R22682	73-03	McLean	Bt	0.4-0.6	67.70	16.20	5.52	1.18	0.51	0.77	1.96
R22683	73-04	McLean	Btj	0.6-0.9	69.60	18.90	5.21	1.21	0.58	1.02	2.10
R22684	73-05	McLean	Btj	0.9-1.0	70.60	14.40	4.81	1.18	0.78	1.15	2.16
R22685	73-06	McLean	C	1.0-1.2	68.20	12.70	4.11	2.39	2.49	1.18	2.13
R23065	88-01	McLean	Ap1	0.0-0.2	71.62	11.48	3.82	0.88	1.08	0.71	2.17
R23066	88-02	McLean	Ap2	0.2-0.4	71.50	12.75	4.23	0.90	0.85	0.75	2.12
R23067	88-03	McLean	Btj	0.4-0.6	69.59	14.37	5.42	1.11	0.82	0.73	2.08
R23068	88-05	McLean	Bt	0.8-0.9	70.52	13.98	5.48	1.16	0.80	0.70	2.28
R23069	88-07	McLean	2BC	1.1-1.2	67.22	13.31	6.91	1.59	1.30	0.53	2.48
R23070	88-08	McLean	2CBt	1.2-1.4	49.50	7.12	3.35	7.98	10.68	0.39	1.81
R22270	53-01	Menard	Ap	0.0-0.2	71.10	10.20	3.34	0.89	0.88	1.04	2.10
R22271	53-02	Menard	AB	0.2-0.4	70.80	11.70	3.50	1.15	0.87	1.17	2.02
R22272	53-03	Menard	BAt	0.4-0.6	68.10	14.50	4.80	1.58	0.91	1.17	1.92
R22273	53-04	Menard	Bt	0.6-0.8	70.90	13.10	4.21	1.53	0.97	1.44	2.18
R22274	53-05	Menard	CB	0.8-1.0	66.30	11.60	3.36	3.37	3.32	1.44	2.19
R22275	53-11	Menard	C	2.3-2.4	60.30	8.30	3.33	4.38	7.76	0.65	2.67
R22342	63-01	Menard	Ap	0.0-0.2	77.40	8.30	3.46	0.92	1.34	0.85	2.16
R22343	63-02	Menard	Ap2	0.2-0.4	79.10	7.80	3.26	0.80	1.21	0.90	2.16
R22344	63-03	Menard	A	0.4-0.6	80.70	7.30	3.27	0.53	0.81	0.82	2.16
R22345	63-06	Menard	Ab	1.0-1.3	80.50	7.78	3.45	0.46	0.70	0.89	2.14
R22346	63-15	Menard	Bwg	2.7-2.9	80.20	7.80	3.55	0.62	0.89	0.90	2.08
R23384	109-1	Mercer	Ap	0.0-0.2	74.67	9.70	3.94	1.05	1.28	0.93	1.97
R23385	109-3	Mercer	A11	0.4-0.6	74.97	8.71	3.15	0.95	1.34	1.02	1.99
R23386	109-4	Mercer	A12	0.6-0.9	75.34	8.72	3.16	0.92	1.29	1.00	2.00
R23387	109-5	Mercer	Btj	0.6-1.1	75.79	10.20	4.51	1.02	0.97	0.84	1.96
R23388	109-7	Mercer	Bk	1.2-1.4	76.17	8.73	4.51	1.20	1.33	0.78	1.89
R23389	109-9	Mercer	2C2	1.6-1.8	68.79	8.45	3.81	2.37	5.23	0.76	1.77

Continued on next page

Electronic Filing: Received, Clerk's Office 3/24/2022

Lab no.	Sample ID	County	Horizon	Depth interval (m)	SiO <sub>2</sub> (%)	Al <sub>2</sub> O <sub>3</sub> (%)	Fe <sub>2</sub> O <sub>3</sub> (%)	MgO (%)	CaO (%)	Na <sub>2</sub> O (%)	K <sub>2</sub> O (%)
R22002	16-01	Monroe	A	0.0–0.1	72.40	11.33	4.63	0.90	0.74	0.88	2.17
R22003	16-02	Monroe	E	0.1–0.3	69.06	13.49	6.33	1.20	0.66	0.88	2.04
R22004	16-03	Monroe	B	0.3–0.6	66.60	14.60	6.41	1.51	0.77	0.89	2.04
R22005	16-04	Monroe	B	0.6–0.9	70.80	12.78	4.96	1.38	1.11	1.19	2.07
R22006	16-16	Monroe	2A	2.8–3.0	75.93	11.63	3.70	0.85	0.88	0.95	1.93
R22007	16-26	Monroe	2B	5.6–5.8	65.10	8.01	2.76	3.56	6.70	0.87	1.94
R22008	17-01	Monroe	A	0.0–0.2	70.36	12.22	3.95	1.14	1.16	1.14	2.52
R22009	17-02	Monroe	A	0.2–0.3	69.92	12.58	4.11	1.18	1.10	1.00	2.54
R22010	17-03	Monroe	A	0.3–0.5	70.20	12.90	4.14	1.23	1.06	1.03	2.49
R22011	17-04	Monroe	A	0.5–0.6	71.95	12.53	4.09	1.21	1.01	1.08	2.41
R22012	17-16	Monroe	C	2.4–3.1	78.50	10.03	2.80	0.78	1.15	1.57	2.29
R22204	42-01	Montgomery	Ap	0.0–0.2	82.60	7.10	2.29	0.39	0.52	0.84	1.85
R22205	42-02	Montgomery	A	0.2–0.4	80.00	8.00	2.80	0.45	0.58	0.87	1.85
R22206	42-04	Montgomery	AB	0.6–0.8	81.80	8.20	2.78	0.46	0.48	0.83	1.80
R22207	42-06	Montgomery	Bw	1.0–1.2	83.80	7.50	2.74	0.43	0.40	0.75	1.56
R22208	42-16	Montgomery	CA	2.8–3.1	87.10	6.20	1.94	0.34	0.46	0.73	1.20
R22209	42-23	Montgomery	D/A	4.3–4.6	76.10	12.10	2.89	0.90	0.79	1.21	2.16
R22240	48-01	Montgomery	Ap	0.0–0.2	78.50	8.50	2.55	0.44	0.85	1.03	2.05
R22241	48-03	Montgomery	Bt1	0.3–0.5	75.10	10.90	3.74	0.73	0.72	0.90	1.97
R22242	48-04	Montgomery	Bt2	0.5–0.6	70.40	13.40	5.31	1.10	0.75	0.80	1.84
R22243	48-06	Montgomery	Bt4	0.8–1.0	70.70	13.20	5.61	1.15	0.78	0.90	1.96
R22244	48-09	Montgomery	C	1.3–1.6	73.70	11.70	4.76	0.90	1.02	1.27	2.16
R22245	48-16	Montgomery	2C1	3.1–3.4	80.00	8.80	3.94	0.60	0.46	0.73	2.25
R22294	57-01	Morgan	Ap	0.0–0.2	77.50	9.50	2.47	0.50	0.59	1.18	2.16
R22295	57-02	Morgan	AE	0.2–0.4	73.61	12.26	4.45	0.77	0.42	0.87	2.35
R22296	57-03	Morgan	Btj	0.4–0.6	70.20	14.10	5.04	1.05	0.48	0.86	2.28
R22297	57-05	Morgan	Bt	0.8–1.0	71.30	13.70	4.98	1.06	0.53	1.05	2.26
R22298	57-11	Morgan	CB	2.0–2.3	75.90	11.00	4.32	0.69	0.95	1.34	2.26
R22299	57-16	Morgan	2A	3.2–3.4	77.40	9.70	4.12	0.65	0.95	1.25	2.28
R23504	122-1*	Ogle	Ap	0.0–0.2	58.61	9.89	6.10	2.03	2.91	0.76	1.90
R23505	122-2*	Ogle	AB	0.2–0.4	68.98	12.44	5.04	1.21	1.22	0.97	2.12
R23506	122-3*	Ogle	Btj	0.4–0.6	71.08	12.90	4.18	1.18	1.09	1.01	2.17
R23507	122-5	Ogle	Btj	0.9–1.0	70.54	14.01	4.80	1.36	1.11	1.07	2.17
R23508	122-8	Ogle	Bt	1.5–1.8	71.98	13.25	4.44	1.36	1.39	1.33	2.24
R23509	122-9	Ogle	C	1.7–2.0	63.19	11.02	3.49	3.73	5.00	1.15	2.19
R23510	123-1	Ogle	Ap	0.0–0.2	71.28	11.78	3.27	1.32	1.51	0.93	2.08
R23511	123-2	Ogle	AB	0.2–0.4	69.66	14.32	4.55	1.31	1.00	0.87	2.02
R23512	123-3	Ogle	Btj	0.4–0.6	69.91	14.55	4.69	1.30	0.97	0.93	2.05
R23513	123-4	Ogle	E'	0.6–0.8	71.10	15.05	3.28	1.11	1.04	1.18	2.31
R23514	123-7	Ogle	2Bg	0.9–1.1	67.71	18.16	2.87	1.38	0.97	0.80	2.25
R23515	123-8	Ogle	3AB	1.1–1.3	70.50	15.99	3.16	1.40	0.96	0.58	2.30
R23089	92-01	Peoria	Ap	0.0–0.2	70.72	10.78	4.10	0.77	1.03	0.81	2.07
R23090	92-02	Peoria	AB	0.2–0.3	69.38	13.64	4.35	1.00	0.83	0.91	2.14
R23091	92-03	Peoria	BA	0.3–0.5	69.93	14.31	5.05	0.99	0.88	0.79	2.13
R23092	92-04	Peoria	Bt	0.5–0.6	71.80	13.36	5.00	1.02	0.90	0.90	2.15
R23093	92-06	Peoria	BCtj	1.1–1.2	73.32	13.45	4.00	0.94	1.07	1.04	2.34
R23094	92-09	Peoria	C	1.6–1.7	65.84	12.31	3.25	2.94	4.05	1.17	2.12
R23095	93-01	Peoria	A/E	0.0–0.2	77.45	10.24	2.62	0.52	0.76	0.99	2.19
R23096	93-02	Peoria	EB	0.2–0.3	74.34	13.23	3.73	0.72	0.75	0.91	2.29
R23097	93-03	Peoria	Bt	0.3–0.5	71.92	14.05	4.79	0.84	0.81	0.81	2.29
R23098	93-04	Peoria	Bt	0.5–0.6	71.57	14.17	5.23	0.91	0.82	0.82	2.23
R23099	93-06	Peoria	Bt2	0.8–1.0	73.56	13.17	4.71	0.82	0.91	0.95	2.33
R23100	93-09	Peoria	2C	1.7–2.0	59.19	10.94	2.88	4.48	6.90	0.58	2.58
R21895	9-01	Perry	Ap	0.0–0.2	78.70	8.00	2.99	0.37	0.83	1.02	1.72
R21896	9-02	Perry	E	0.2–0.4	81.40	8.10	2.95	0.35	0.52	1.07	1.74
R21897	9-03	Perry	E	0.4–0.6	78.60	9.40	3.75	0.46	0.53	1.00	1.78
R21898	9-07	Perry	B	0.8–1.1	71.50	13.20	5.51	0.97	0.60	1.05	1.97

Continued on next page

Electronic Filing: Received, Clerk's Office 3/24/2022

Lab no.	Sample ID	County	Horizon	Depth interval (m)	SiO <sub>2</sub> (%)	Al <sub>2</sub> O <sub>3</sub> (%)	Fe <sub>2</sub> O <sub>3</sub> (%)	MgO (%)	CaO (%)	Na <sub>2</sub> O (%)	K <sub>2</sub> O (%)
R21899	9-12	Perry	B	1.8–2.1	78.90	10.40	2.21	0.62	1.00	1.31	2.02
R21900	9-20	Perry	3B	3.5–3.7	75.70	8.90	7.55	0.37	0.60	0.45	1.44
R21901	10-01	Perry	Ap	0.0–0.2	74.80	11.10	4.05	0.81	0.79	1.19	1.89
R21902	10-02	Perry	EB	0.2–0.4	76.00	10.80	3.68	0.77	0.83	1.25	1.98
R21903	10-03	Perry	EB	0.4–0.5	78.60	10.30	2.98	0.59	0.70	1.10	1.86
R21904	10-05	Perry	B	0.8–1.0	78.90	9.80	3.51	0.52	0.63	0.97	1.65
R21905	10-10	Perry	B	1.9–2.0	75.90	11.70	3.98	0.66	0.65	0.87	1.69
R21906	10-16	Perry	BC	4.4–4.6	79.60	9.00	3.67	0.54	0.54	0.89	1.72
R22222	45-01	Pike	Ap	0.0–0.3	79.10	7.90	2.21	0.64	2.12	1.14	1.98
R22223	45-02	Pike	E2	0.3–0.6	78.10	10.20	3.51	0.64	0.54	1.07	2.09
R22224	45-03	Pike	E2	0.6–0.9	73.10	12.60	5.08	0.97	0.47	0.99	2.06
R22225	45-05	Pike	Bt	1.0–1.2	72.30	12.70	5.56	1.05	0.56	1.03	2.15
R22226	45-09	Pike	C	1.8–2.0	75.90	10.80	4.10	0.83	0.99	1.47	2.32
R22227	45-17	Pike	2Bt	3.7–4.0	70.00	15.00	6.24	0.85	0.43	0.40	1.21
R22300	58-01	Pike	Ap	0.0–0.3	79.80	7.20	2.56	0.37	1.34	0.96	2.08
R22301	58-02	Pike	E	0.3–0.4	80.20	9.20	2.87	0.43	0.47	0.95	2.19
R22302	58-03	Pike	Bt	0.4–0.6	71.40	13.00	5.97	0.85	0.62	0.60	1.99
R22303	58-04	Pike	Bt	0.6–0.9	72.20	12.60	5.88	0.86	0.51	0.62	2.01
R22304	58-07	Pike	Btj	1.2–1.4	73.50	12.00	5.36	0.83	0.62	0.85	2.16
R22305	58-10	Pike	C	1.7–2.0	61.60	8.20	3.38	4.80	6.99	0.81	2.01
R22306	58-31	Pike	2Ab	5.6–5.7	76.20	10.50	3.50	0.75	1.26	1.46	2.26
R22307	59-01	Pike	Ap	0.0–0.1	73.80	11.50	4.43	0.68	0.56	0.86	2.00
R22308	59-02	Pike	Bt	0.1–0.3	71.20	13.70	5.51	0.93	0.46	0.84	2.03
R22309	59-03	Pike	Bt	0.3–0.5	72.10	12.90	5.98	0.86	0.38	0.76	1.99
R22310	59-06	Pike	Bt	0.9–1.0	73.40	11.90	5.79	0.84	0.51	0.90	2.15
R22311	59-13	Pike	3EB	2.1–2.2	77.10	10.20	4.49	0.60	0.62	0.91	2.01
R22312	59-16	Pike	4Bt	2.5–2.7	80.50	8.80	3.81	0.43	0.35	0.62	1.46
R21832	4-01	Pope	A	0.0–0.2	64.80	14.80	5.93	1.12	0.55	0.51	2.66
R21833	4-02	Pope	A	0.2–0.3	64.50	15.60	6.12	1.13	0.49	0.48	2.70
R21834	4-03	Pope	AB	0.3–0.5	64.20	16.30	6.44	1.16	0.50	0.47	2.76
R21835	4-04	Pope	B	0.5–0.6	63.90	16.50	6.62	1.14	0.31	0.48	2.78
R21836	4-08	Pope	B	1.1–1.2	63.20	17.30	7.04	1.28	0.30	0.46	2.82
R21837	4-12	Pope	B	1.7–1.8	63.60	17.00	6.84	1.27	0.35	0.49	2.84
R21773	5-01	Pope	A	0.0–0.1	78.70	8.10	2.40	0.40	0.43	0.72	1.81
R21774	5-02	Pope	E	0.1–0.2	79.80	8.60	2.59	0.41	0.26	0.70	1.80
R21775	5-03	Pope	B	0.2–0.4	78.00	10.00	3.43	0.54	0.24	0.71	1.88
R21776	5-04	Pope	B	0.4–0.6	74.10	11.90	4.62	0.77	0.25	0.74	1.87
R21777	5-07	Pope	B	1.2–1.5	75.90	10.80	4.46	0.78	0.40	1.16	2.12
R21778	5-14	Pope	3EB	2.4–2.6	80.40	9.00	3.07	0.60	0.41	0.77	1.45
R21826	1-01	Pulaski	Ap	0.0–0.2	68.10	13.40	4.90	1.09	1.00	0.85	2.41
R21827	1-02	Pulaski	AB	0.2–0.3	69.10	13.80	4.68	1.19	0.81	0.85	2.36
R21828	1-03	Pulaski	BA	0.3–0.5	68.30	14.20	4.75	1.28	0.76	0.79	2.36
R21829	1-04	Pulaski	B	0.5–0.6	68.30	14.40	4.79	1.33	0.77	0.78	2.36
R21830	1-08	Pulaski	B	1.2–1.4	67.30	15.30	5.17	1.56	0.77	0.76	2.44
R21831	1-11	Pulaski	B	2.4–2.6	66.20	15.40	5.53	1.68	0.89	0.70	2.36
R23201	105-1	Putnam	Ap	0.0–0.3	72.31	12.37	3.53	0.97	0.87	0.97	2.09
R23202	105-2	Putnam	AB	0.3–0.5	69.73	14.32	4.61	1.18	0.90	0.80	2.03
R23203	105-3	Putnam	Bt	0.5–0.6	68.24	16.01	5.00	1.33	0.92	0.84	1.99
R23204	105-5	Putnam	Bt2	0.8–1.0	70.76	14.60	4.61	1.23	1.03	1.11	2.15
R23205	105-7	Putnam	2C	1.2–1.4	52.72	13.29	4.25	5.00	7.31	0.49	3.27
R23206	105-12	Putnam	2C	2.2–2.4	49.95	13.11	3.93	5.41	8.37	0.44	3.36
R22144	33-01	Richland	Ap	0.0–0.2	75.20	9.10	3.02	0.50	0.77	0.96	1.42
R22145	33-02	Richland	A2	0.2–0.3	76.80	9.40	3.30	0.43	0.50	0.96	1.41
R22146	33-03	Richland	AB	0.3–0.5	80.50	8.50	2.80	0.39	0.75	1.01	1.46
R22147	33-04	Richland	B1	0.5–0.6	80.20	8.80	3.35	0.37	0.32	1.09	1.60
R22148	33-06	Richland	B3	0.7–1.3	74.30	12.50	4.12	0.68	0.45	1.02	1.58
R22149	33-10	Richland	C3g	2.6–2.7	71.00	13.90	5.41	0.78	0.51	0.84	1.66

Continued on next page

Electronic Filing: Received, Clerk's Office 3/24/2022

Lab no.	Sample ID	County	Horizon	Depth interval (m)	SiO <sub>2</sub> (%)	Al <sub>2</sub> O <sub>3</sub> (%)	Fe <sub>2</sub> O <sub>3</sub> (%)	MgO (%)	CaO (%)	Na <sub>2</sub> O (%)	K <sub>2</sub> O (%)
R21779	6-01	Saline	Ap	0.0-0.2	76.00	9.50	4.18	0.66	0.94	0.81	1.98
R21780	6-02	Saline	B	0.2-0.5	69.10	14.50	5.60	1.17	0.47	0.71	2.32
R21781	6-03	Saline	B	0.5-0.7	67.40	15.50	5.68	1.46	0.28	0.78	2.50
R21782	6-04	Saline	B	0.7-1.0	67.50	15.30	5.60	1.53	0.30	0.89	2.62
R21783	6-06	Saline	B	1.1-1.3	66.70	15.20	5.85	1.79	0.55	1.07	2.94
R21784	6-20	Saline	2B	3.8-4.0	47.80	13.70	5.40	4.54	9.57	0.78	3.16
R22282	55-01	Sangamon	A	0.0-0.2	74.60	10.90	3.54	0.76	0.74	1.05	2.29
R22283	55-03	Sangamon	A	0.3-0.5	77.00	10.10	3.16	0.67	0.83	1.19	2.21
R22284	55-06	Sangamon	A	0.9-1.1	77.80	9.48	2.97	0.66	0.84	1.19	2.19
R22285	55-08	Sangamon	A	1.3-1.5	78.60	9.30	2.91	0.67	0.79	1.16	2.17
R22286	55-11	Sangamon	Bw	2.1-2.3	79.30	9.10	2.85	0.65	0.75	1.16	2.13
R22287	55-28	Sangamon	2C	5.2-5.6	46.53	18.75	6.34	4.73	5.98	0.42	4.74
R22288	56-01	Sangamon	A	0.0-0.2	72.00	10.00	3.64	0.70	1.06	0.99	2.00
R22289	56-02	Sangamon	A	0.2-0.5	71.80	10.50	3.74	0.75	1.07	0.92	1.96
R22290	56-03	Sangamon	AB	0.5-0.6	70.90	12.00	4.28	0.92	0.91	0.98	1.88
R22291	56-05	Sangamon	Bt	0.8-1.0	67.60	14.10	6.37	1.24	0.86	1.08	1.92
R22292	56-07	Sangamon	Bt	1.2-1.5	71.10	12.40	5.87	1.08	0.89	1.22	2.14
R22293	56-11	Sangamon	C	2.6-2.7	72.60	11.50	3.31	1.49	2.03	1.74	2.30
R22252	50-01	Shelby	Ap	0.0-0.2	74.70	10.70	3.83	0.71	0.57	0.77	2.03
R22253	50-02	Shelby	AB	0.2-0.4	71.60	12.70	5.03	1.03	0.58	0.70	2.02
R22254	50-03	Shelby	BA	0.4-0.6	70.60	13.20	5.57	1.15	0.57	0.74	2.14
R22255	50-05	Shelby	Bt	0.8-1.1	72.00	12.80	5.09	1.26	0.69	0.66	2.89
R22256	50-07	Shelby	C	1.2-1.5	57.90	8.60	3.33	4.56	9.14	0.51	2.72
R22257	50-16	Shelby	D	3.1-3.4	56.60	8.30	3.12	4.81	9.24	0.52	2.65
R22098	27-1	St. Clair	Ap	0.0-0.2	81.10	8.00	1.97	0.35	0.71	1.20	1.97
R22099	27-2	St. Clair	A2	0.2-0.3	80.10	8.90	2.40	0.48	0.72	1.23	2.09
R22100	27-3	St. Clair	B	0.3-0.5	75.90	10.90	3.54	0.69	0.76	1.05	2.03
R22101	27-4	St. Clair	B2	0.5-0.8	71.70	12.70	5.15	1.03	0.72	0.90	1.97
R22102	27-9	St. Clair	C2	1.9-2.1	70.20	9.90	4.05	2.43	3.11	1.36	2.07
R22103	27-13	St. Clair	2A	3.6-3.9	74.00	10.20	2.57	1.73	2.54	1.54	2.26
R23498	121-1	Stephenson	Ap	0.0-0.2	71.40	9.63	3.37	1.66	1.97	0.87	1.99
R23499	121-2	Stephenson	C	0.2-0.4	77.09	9.52	3.11	0.99	0.97	0.97	1.99
R23500	121-3	Stephenson	2A1	0.4-0.6	74.60	10.42	3.50	1.05	0.98	0.91	2.04
R23501	121-5	Stephenson	3Ab	0.8-1.0	72.18	10.81	3.72	1.07	1.01	0.87	2.01
R23502	121-8	Stephenson	3BA	1.3-1.5	71.13	13.00	4.80	1.36	0.95	0.93	2.04
R23503	121-10	Stephenson	3CB	1.7-1.9	71.62	13.13	4.82	1.38	1.08	1.08	2.12
R23053	86-01	Tazewell	Ap	0.0-0.2	78.13	9.02	2.48	0.47	1.24	0.90	2.01
R23054	86-02	Tazewell	E	0.2-0.4	75.14	11.43	4.04	0.69	0.72	0.82	2.11
R23055	86-03	Tazewell	Bt	0.4-0.6	69.01	14.59	5.78	1.08	0.80	0.63	1.95
R23056	86-05	Tazewell	Bt	0.8-1.0	71.10	13.78	5.33	0.98	0.83	0.80	2.06
R23057	86-07	Tazewell	B3	1.2-1.5	72.22	12.94	5.12	1.03	0.92	0.90	2.34
R23058	86-12	Tazewell	C	2.1-2.3	64.26	10.06	3.38	3.67	5.16	0.90	2.11
R21759	2-01	Union	Ap	0.0-0.2	77.10	9.40	2.98	0.61	0.76	0.81	2.14
R21760	2-02	Union	B	0.2-0.4	74.50	11.50	4.18	0.87	0.47	0.79	2.28
R21761	2-03	Union	B	0.4-0.6	73.50	12.10	4.69	0.94	0.31	0.83	2.31
R21762	2-04	Union	E	0.6-0.8	73.70	11.70	4.77	0.94	0.31	0.93	2.30
R21763	2-06	Union	2B	0.8-1.2	73.30	12.20	4.59	0.99	0.41	1.01	2.26
R21764	2-13	Union	2A	2.4-3.1	76.10	10.70	3.63	0.83	0.97	1.38	2.39
R21765	2-26	Union	4B	4.9-5.2	78.50	10.90	3.11	0.46	0.24	0.49	1.53
R22377	68-01	Vermilion	Ap	0.0-0.2	77.80	8.21	3.83	0.43	0.66	0.61	1.94
R22378	68-02	Vermilion	AB	0.2-0.4	70.80	13.20	6.00	0.90	0.61	0.52	1.83
R22379	68-03	Vermilion	Btg	0.4-0.6	68.80	14.30	6.73	1.02	0.56	0.58	1.86
R22380	68-04	Vermilion	Btg	0.6-0.9	70.30	13.80	6.35	1.03	0.65	0.75	1.96
R22381	68-06	Vermilion	BC	1.0-1.2	80.90	7.86	4.12	0.67	0.46	0.71	2.34
R22382	68-09	Vermilion	C	1.7-1.8	59.70	8.00	3.73	4.26	8.38	0.47	2.99
R22506	69-01	Vermilion	Ap	0.0-0.2	98.80	12.60	4.74	0.88	0.57	0.45	2.92

Continued on next page



## Electronic Filing: Received, Clerk's Office 3/24/2022

Lab no.	Sample ID	County	Horizon	Depth interval (m)	SiO <sub>2</sub> (%)	Al <sub>2</sub> O <sub>3</sub> (%)	Fe <sub>2</sub> O <sub>3</sub> (%)	MgO (%)	CaO (%)	Na <sub>2</sub> O (%)	K <sub>2</sub> O (%)
R22507	69-03	Vermilion	A	0.4–0.6	72.10	11.20	4.20	0.90	0.80	0.50	2.60
R22508	69-04	Vermilion	A	0.6–0.9	73.40	11.40	4.30	0.98	0.82	0.56	2.51
R22509	69-05	Vermilion	AB	0.9–1.1	77.40	9.60	4.27	0.84	0.64	0.54	2.29
R22510	69-08	Vermilion	2C1	1.4–1.8	57.90	9.70	4.53	4.32	6.99	0.38	3.62
R22511	69-11	Vermilion	2C2	2.1–2.4	57.20	9.52	4.17	4.71	7.36	0.35	3.58
R22043	23-01	Wabash	A	0.0–0.2	76.03	7.90	2.85	0.84	1.61	0.91	1.92
R22044	23-02	Wabash	A	0.2–0.3	73.48	12.43	4.59	0.91	0.30	0.92	1.82
R22045	23-03	Wabash	B	0.3–0.5	78.15	9.64	3.18	0.54	0.49	0.91	2.06
R22046	23-04	Wabash	A'	0.5–0.7	73.17	12.46	5.04	0.95	0.50	0.80	2.14
R22047	23-08	Wabash	C	1.5–1.8	74.00	11.39	4.94	0.98	0.65	1.11	2.60
R22048	23-14	Wabash	C	3.1–3.4	76.80	10.87	4.63	0.57	0.44	0.64	1.50
R23077	90-01	Warren	Ap	0.0–0.3	72.18	10.83	3.22	0.78	2.01	0.84	1.86
R23078	90-02	Warren	BA	0.3–0.5	73.04	11.94	3.96	0.72	0.96	0.87	1.90
R23079	90-03	Warren	Btj	0.5–0.7	72.19	13.28	4.62	0.92	0.89	0.87	1.93
R23080	90-05	Warren	Bw	0.9–1.1	71.88	13.80	4.77	1.01	1.03	1.01	1.96
R23081	90-07	Warren	BCtj	1.3–1.5	73.03	13.16	4.61	0.94	1.11	1.06	2.02
R23082	90-11	Warren	C	2.1–2.3	66.45	10.71	3.64	3.09	4.42	1.00	1.86
R21990	14-01	Washington	Ap	0.0–0.1	78.56	7.33	3.09	0.35	0.57	0.88	1.75
R21991	14-02	Washington	Ap	0.1–0.2	79.39	7.57	2.95	0.35	0.57	0.88	1.75
R21992	14-03	Washington	A	0.2–0.4	79.56	8.53	3.28	0.47	0.46	0.94	1.88
R21993	14-04	Washington	E	0.4–0.6	76.14	11.10	4.31	0.78	0.37	0.95	1.93
R21994	14-06	Washington	B	0.9–1.1	73.29	12.28	5.23	0.92	0.50	1.06	1.99
R21995	14-15	Washington	2B	2.0–2.2	78.67	9.94	3.40	0.55	0.61	1.12	1.75
R21996	15-01	Washington	A	0.0–0.3	81.10	8.10	2.10	0.27	0.56	1.08	1.52
R21997	15-02	Washington	A	0.3–0.5	79.72	8.87	3.48	0.34	0.38	1.09	1.59
R21998	15-03	Washington	E	0.5–0.6	67.83	14.07	7.06	0.83	0.38	0.80	1.46
R21999	15-04	Washington	B	0.9–1.0	62.54	17.55	7.87	1.12	0.40	0.64	1.40
R22000	15-13	Washington	B	2.1–2.7	77.37	11.27	2.75	0.58	0.71	1.10	1.84
R22001	15-20	Washington	C	4.6–4.9	73.98	11.89	5.41	0.76	0.55	0.83	1.87
R22031	21-01	Wayne	A	0.0–0.1	77.17	8.71	2.71	0.40	0.58	0.90	1.56
R22032	21-02	Wayne	A	0.1–0.3	79.84	8.78	2.74	0.37	0.43	0.89	1.57
R22033	21-03	Wayne	E	0.3–0.6	80.83	8.51	2.93	0.33	0.29	0.92	1.63
R22034	21-04	Wayne	B	0.6–0.9	70.86	14.46	4.72	0.73	0.31	0.76	1.55
R22035	21-07	Wayne	B	1.4–1.8	76.44	11.88	2.83	0.65	0.49	1.05	1.87
R22036	21-10	Wayne	B	2.0–2.3	75.36	12.36	3.62	0.60	0.47	0.80	1.66
R22055	25-01	Wayne	A	0.0–0.2	78.41	9.85	3.22	0.43	0.37	1.02	2.08
R22056	25-02	Wayne	C	0.2–0.3	78.55	10.07	3.25	0.41	0.29	1.03	2.07
R22057	25-03	Wayne	C	0.3–0.6	77.41	10.70	3.66	0.54	0.29	1.02	2.10
R22058	25-04	Wayne	C	0.6–0.9	75.46	11.88	3.99	0.64	0.31	0.96	2.15
R22059	25-22	Wayne	2C	2.6–2.7	68.65	14.05	5.66	1.28	0.93	0.88	2.70
R22060	25-29	Wayne	2C	4.4–4.8	67.01	16.02	6.12	1.05	0.45	0.78	2.54
R21985	13-01	White	Ap	0.0–0.2	84.50	6.00	1.85	0.21	0.79	0.92	1.68
R21986	13-02	White	B	0.2–0.4	84.28	7.07	2.20	0.29	0.55	0.90	1.95
R21987	13-03	White	B	0.4–0.6	80.72	8.65	3.16	0.43	0.57	0.91	2.05
R21988	13-04	White	B	0.6–0.9	80.19	9.09	3.35	0.45	0.62	0.95	2.05
R21989	13-18	White	C	3.2–4.0	86.99	5.97	1.77	0.37	0.75	1.26	1.35
R23449	117-1	Whiteside	Ap	0.0–0.2	74.77	9.39	3.18	1.14	1.47	1.11	1.90
R23450	117-2	Whiteside	A2	0.2–0.4	78.02	8.32	2.68	1.16	1.70	1.16	1.78
R23451	117-3	Whiteside	Ab	0.4–0.6	77.64	7.84	2.50	1.00	1.61	1.19	1.68
R23452	117-5	Whiteside	Ab	0.9–1.1	80.82	7.79	2.36	0.86	1.33	1.23	1.68
R23453	117-6	Whiteside	Ab	1.1–1.3	81.99	7.62	2.27	0.85	1.27	1.22	1.68
R23454	117-8	Whiteside	AB	1.5–1.7	82.86	7.55	2.28	0.85	1.28	1.26	1.69
R23534	127-1	Will	A	0.0–0.2	67.09	12.79	4.56	1.49	1.18	0.70	2.64
R23535	127-3	Will	Bgtj	0.3–0.5	64.51	14.95	5.72	2.19	1.37	0.68	3.25
R223536	127-4	Will	BCK	0.5–0.7	55.61	13.38	4.85	3.98	6.05	0.61	3.26
R23537	127-5	Will	BCK	0.7–0.9	52.09	12.57	4.38	4.17	8.51	0.54	3.22
R23538	127-6	Will	BCK	0.9–1.0	52.81	13.07	4.53	4.40	7.39	0.57	3.39

*Continued on next page*

Electronic Filing: Received, Clerk's Office 3/24/2022

Lab no.	Sample ID	County	Horizon	Depth interval (m)	SiO <sub>2</sub> (%)	Al <sub>2</sub> O <sub>3</sub> (%)	Fe <sub>2</sub> O <sub>3</sub> (%)	MgO (%)	CaO (%)	Na <sub>2</sub> O (%)	K <sub>2</sub> O (%)
R23539	127-7	Will	C	1.0-1.2	53.23	13.26	4.54	4.48	6.84	0.59	3.48
R23802	137-1	Will	Ap	0.0-0.3	71.19	11.10	4.10	1.33	1.31	0.72	2.32
R23803	137-2	Will	B1t	0.3-0.5	69.29	13.43	5.50	1.51	1.05	0.72	2.18
R23804	137-3	Will	B2tj	0.5-0.6	69.37	13.39	5.90	1.49	0.99	0.76	2.35
R23805	137-4	Will	B2tj	0.6-0.8	66.19	14.61	7.02	1.65	0.80	0.58	3.42
R23806	137-5	Will	B3t	0.8-1.0	65.34	14.74	7.44	1.74	0.83	0.57	3.66
R23807	137-6	Will	2C	1.0-1.2	57.84	12.96	5.19	4.07	4.77	0.57	3.30
R21785	7-01	Williamson	A	0.0-0.2	76.80	8.30	2.87	0.47	0.90	0.78	1.81
R21786	7-02	Williamson	BA	0.2-0.3	75.60	11.00	3.91	0.74	0.35	0.81	1.99
R21787	7-03	Williamson	B	0.3-0.5	74.10	11.30	4.31	0.85	0.28	0.82	1.99
R21788	7-06	Williamson	B	0.7-0.9	72.70	12.40	5.12	1.07	0.43	1.08	2.16
R21789	7-21	Williamson	BE	3.8-4.3	77.50	11.10	3.25	0.57	0.36	1.13	1.96
R23516	124-1	Winnebago	Ap	0.0-0.2	81.32	7.16	2.76	1.02	1.01	0.60	2.01
R23517	124-2	Winnebago	Btj	0.2-0.3	81.26	7.65	2.86	1.15	1.08	0.68	2.20
R23518	124-3	Winnebago	C	0.3-0.5	67.52	6.20	2.04	4.35	5.98	0.60	1.92
R23519	124-4	Winnebago	C	0.5-0.6	61.79	5.77	1.81	5.14	8.53	0.56	1.78
R23520	124-5	Winnebago	C	0.6-0.8	60.52	5.72	1.66	5.21	9.26	0.56	1.80
R23521	124-7	Winnebago	C	1.0-1.2	60.52	5.66	1.66	5.25	9.35	0.57	1.79
R23059	87-01	Woodford	Ap	0.0-0.2	77.80	9.35	3.15	0.48	0.79	0.88	1.91
R23060	87-02	Woodford	AE	0.4-0.5	79.40	9.18	2.70	0.42	0.74	0.88	1.90
R23061	87-03	Woodford	EB	0.4-0.6	79.45	9.09	2.78	0.43	0.70	0.88	1.89
R23062	87-04	Woodford	Bt	0.6-0.8	70.67	13.52	5.12	1.10	0.94	0.90	2.08
R23063	87-05	Woodford	BC	0.8-1.0	72.60	12.39	4.86	1.06	1.13	1.10	2.22
R23064	87-06	Woodford	C	1.0-1.2	62.56	10.29	3.77	3.97	5.39	0.93	2.01
R23117	94-01	Woodford	Ap	0.0-0.3	69.22	13.19	3.52	0.82	1.83	0.85	2.05
R23118	94-02	Woodford	A	0.3-0.5	70.59	12.54	4.19	0.90	1.13	0.83	2.03
R23119	94-04	Woodford	Bgt	0.6-0.8	69.96	14.85	4.79	1.09	1.04	0.84	2.06
R23120	94-06	Woodford	Bgtj	0.9-1.1	69.97	14.51	4.78	1.36	1.44	0.95	2.10
R23121	94-08	Woodford	C	1.3-1.4	57.69	11.56	3.10	4.87	6.90	0.88	1.78
R23122	94-12	Woodford	2C	2.0-2.2	52.92	7.76	2.36	6.54	10.56	0.44	1.22

Continued on next page

Electronic Filing: Received, Clerk's Office 3/24/2022

Lab no.	Sample ID	County	TiO <sub>2</sub> (%)	P <sub>2</sub> O <sub>5</sub> (%)	MnO (%)	Tot. C (%)	Inc. C (%)	Org. C (%)	pH	Ba	Cr	Cu	Hg (µg/g)	Ni
R22313	60-01	Adams	0.72	0.13	0.11	2.72	0.05	2.67	6.66	360	10	20	18	8
R22314	60-02	Adams	0.69	0.11	0.09	1.19	0.03	1.16	5.98	238	20	20	18	8
R22315	60-03	Adams	0.72	0.08	0.11	0.62	0.04	0.58	6.12	253	18	19	11	5
R22316	60-06	Adams	0.63	0.10	0.10	0.59	0.03	0.56	5.54	243	80	32	34	18
R22317	60-21	Adams	0.69	0.04	0.10	0.19	0.03	0.16	6.85	<100	153	25	16	24
R22318	60-40	Adams	0.52	0.07	0.06	0.80	0.70	0.10	8.16	<100	205	25	20	42
R22110	29-01	Bond	0.71	0.15	0.12	2.13	0.07	2.06	6.56	693	20	20	28	7
R22111	29-02	Bond	0.77	0.12	0.13	1.34	0.04	1.30	6.65	703	21	19	20	9
R22112	29-03	Bond	0.79	0.10	0.13	0.93	0.04	0.89	6.49	745	24	19	17	6
R22113	29-04	Bond	0.79	0.11	0.09	0.53	0.06	0.47	5.41	665	59	28	22	16
R22114	29-09	Bond	0.60	0.06	0.04	0.24	0.05	0.19	7.10	541	62	18	13	25
R22115	29-14	Bond	0.26	0.05	0.08	0.14	0.04	0.10	7.02	380	<5	18	15	7
R23522	125-1	Boone	0.70	0.16	0.16	2.64	0.11	2.53	5.47	719	80	21	40	31
R23523	125-2	Boone	0.65	0.14	0.13	2.50	0.08	2.42	5.96	648	91	21	40	32
R23524	125-3	Boone	0.73	0.07	0.07	0.61	0.11	0.50	6.50	719	88	18	35	38
R23525	125-4	Boone	0.69	0.10	0.28	0.43	0.06	0.37	6.97	904	268	26	52	38
R23526	125-6	Boone	0.34	0.06	0.02	0.27	0.05	0.22	7.68	428	269	16	21	39
R23527	125-10	Boone	0.34	0.08	0.04	4.13	3.69	0.44	8.28	336	73	14	10	20
R22329	61-01	Brown	0.68	0.11	0.16	2.12	0.64	1.48	7.60	476	28	22	25	11
R22330	61-02	Brown	0.69	0.12	0.06	0.43	0.07	0.36	7.38	288	76	33	30	18
R22331	61-03	Brown	0.71	0.10	0.05	0.26	0.04	0.22	7.01	214	83	36	18	21
R22332	61-04	Brown	0.71	0.10	0.22	0.28	0.03	0.25	6.48	250	114	28	26	19
R22333	61-10	Brown	0.78	0.16	0.18	0.16	0.04	0.12	7.43	333	44	24	27	11
R22334	61-18	Brown	0.68	0.04	0.15	0.16	0.03	0.13	7.18	162	101	22	33	19
R23338	106-1	Bureau	0.72	0.15	0.12	1.65	0.11	1.54	7.11	768	116	24	44	33
R23339	106-2	Bureau	0.73	0.10	0.11	1.05	0.04	1.01	6.76	672	120	29	47	33
R23340	106-3	Bureau	0.71	0.09	0.09	0.61	0.08	0.53	6.76	668	172	30	45	40
R23341	106-4	Bureau	0.70	0.10	0.11	0.47	0.07	0.40	6.51	576	97	41	47	32
R23342	106-6	Bureau	0.70	0.14	0.10	0.28	0.06	0.22	7.14	554	163	31	25	42
R23343	106-8	Bureau	0.53	0.11	0.08	3.21	3.09	0.12	8.36	406	122	24	17	32
R23402	112-1	Bureau	0.69	0.19	0.14	2.10	0.23	1.87	7.00	754	79	22	30	21
R23403	112-3	Bureau	0.72	0.09	0.10	1.11	0.10	1.01	6.86	748	139	26	34	27
R23404	112-4	Bureau	0.67	0.09	0.10	0.66	0.12	0.54	6.58	812	76	27	42	27
R23405	112-6	Bureau	0.62	0.14	0.10	0.62	0.09	0.53	6.38	779	129	27	38	31
R23406	112-8	Bureau	0.61	0.15	0.12	0.37	0.06	0.31	6.60	743	66	22	32	36
R23407	112-10	Bureau	0.59	0.15	0.10	0.49	0.10	0.39	6.94	668	90	20	29	32
R23408	113-1	Bureau	0.71	0.11	0.09	1.97	0.15	1.82	5.67	767	79	23	41	27
R23409	113-2	Bureau	0.68	0.08	0.08	0.94	0.10	0.84	5.82	748	197	31	61	33
R23410	113-3	Bureau	0.67	0.08	0.08	0.66	0.13	0.53	6.15	713	146	28	46	41
R23411	113-4	Bureau	0.65	0.13	0.12	0.93	0.43	0.50	7.07	750	102	28	40	46
R23412	113-5	Bureau	0.53	0.13	0.10	3.09	2.75	0.34	8.22	599	84	27	22	29
R23413	113-6	Bureau	0.42	0.11	0.08	4.10	3.85	0.25	8.29	452	37	23	15	18
R23455	118-1	Carroll	0.71	0.16	0.18	1.64	0.42	1.22	6.86	695	56	20	26	29
R23456	118-2	Carroll	0.74	0.11	0.12	0.51	0.11	0.40	7.02	687	82	22	23	32
R23457	118-3	Carroll	0.73	0.10	0.08	0.37	0.09	0.28	7.32	763	79	24	39	28
R23458	118-5	Carroll	0.66	0.12	0.07	0.29	0.07	0.22	7.06	741	102	27	48	29
R23459	118-8	Carroll	0.65	0.15	0.12	0.24	0.10	0.14	5.84	821	103	29	42	38
R23460	118-11	Carroll	0.72	0.13	0.09	0.31	0.11	0.20	5.96	610	68	27	30	36
R22335	62-01	Cass	0.20	0.07	0.07	0.44	0.03	0.41	5.40	203	<5	17	8	9
R22336	62-02	Cass	0.20	0.07	0.07	0.27	0.03	0.24	6.06	185	285	17	10	23
R22337	62-03	Cass	0.20	0.07	0.07	0.29	0.03	0.26	5.81	177	<5	16	14	24
R22338	62-05	Cass	0.21	0.05	0.04	0.15	0.03	0.12	6.04	238	78	17	<7	17
R22339	62-07	Cass	0.16	0.05	0.03	0.14	0.02	0.12	6.34	140	166	19	<5	20
R22340	62-17	Cass	0.10	0.06	0.03	0.13	0.03	0.10	6.08	108	161	21	<5	129
R22341	62-18	Cass	0.08	0.03	0.02	0.06	0.02	0.04	6.52	<100	156	17	<5	28
R22359	65-01	Champaign	0.78	0.11	0.16	1.91	0.03	1.88	5.96	393	60	22	18	12
R22360	65-02	Champaign	0.79	0.10	0.15	1.68	0.02	1.66	7.09	439	68	23	24	14
R22361	65-03	Champaign	0.69	0.06	0.14	0.92	0.03	0.89	6.06	194	114	33	45	21

Continued on next page



Electronic Filing: Received, Clerk's Office 3/24/2022

Lab no.	Sample ID	County	TiO <sub>2</sub> (%)	P <sub>2</sub> O <sub>5</sub> (%)	MnO (%)	Tot. C (%)	Inc. C (%)	Org. C (%)	pH	Ba	Cr	Cu	Hg (µg/g)	Ni
R22362	65-04	Champaign	0.67	0.06	0.14	0.59	0.04	0.55	6.16	227	137	32	38	35
R22363	65-05	Champaign	0.74	0.10	0.12	0.59	0.04	0.55	6.80	447	51	27	23	19
R22364	65-11	Champaign	0.48	0.06	0.07	2.51	2.23	0.28	7.96	138	<50	22	5	<5
R22512	70-01	Champaign	0.67	0.14	0.07	2.46	0.04	2.42	5.19	282	45	29	29	12
R22513	70-02	Champaign	0.55	0.16	0.04	3.79	0.03	3.76	5.58	256	66	35	31	17
R22514	70-03	Champaign	0.53	0.11	0.05	1.79	0.03	1.76	6.26	171	102	32	30	14
R22515	70-04	Champaign	0.59	0.13	0.12	0.81	0.03	0.78	6.61	267	101	28	38	17
R22516	70-05	Champaign	0.56	0.10	0.08	1.13	0.03	1.10	6.53	426	72	27	28	14
R22517	70-08	Champaign	0.34	0.09	0.03	1.06	0.72	0.34	8.06	260	4	31	18	7
R22518	71-01	Champaign	0.63	0.20	0.10	2.70	0.88	1.82	7.48	330	30	26	36	13
R22519	71-02	Champaign	0.69	0.14	0.10	1.54	0.08	1.46	7.40	364	74	28	40	18
R22520	71-03	Champaign	0.68	0.12	0.13	0.78	0.04	0.74	7.64	295	112	29	43	27
R22521	71-04	Champaign	0.50	0.13	0.10	3.20	2.43	0.77	8.16	203	14	23	21	14
R22522	71-05	Champaign	0.44	0.11	0.08	4.38	3.81	0.57	8.26	175	<5	23	16	8
R22523	71-10	Champaign	0.58	0.07	0.08	2.60	2.38	0.22	8.11	186	39	24	10	<5
R22698	76-01	Champaign	0.67	0.14	0.09	2.00	0.13	1.87	4.76	570	47	17	28	9
R22699	76-03	Champaign	0.76	0.09	0.07	0.88	0.05	0.83	6.20	922	173	24	47	20
R22700	76-04	Champaign	0.75	0.13	0.13	0.70	0.07	0.63	6.67	1,397	92	21	43	21
R22701	76-05	Champaign	0.76	0.14	0.19	0.52	0.06	0.46	7.40	1,267	50	21	31	16
R22702	76-06	Champaign	0.75	0.14	0.31	0.39	0.06	0.33	7.63	1,467	37	18	28	18
R22703	76-08	Champaign	0.43	0.07	0.11	1.74	1.57	0.17	8.06	786	56	16	12	8
R22246	49-01	Christian	0.79	0.16	0.06	1.59	0.03	1.56	6.50	608	ND	ND	21	ND
R22247	49-02	Christian	0.79	0.07	0.07	1.07	0.04	1.03	6.19	690	ND	ND	25	ND
R22248	49-03	Christian	0.81	0.10	0.08	0.60	0.04	0.56	6.22	723	ND	ND	42	ND
R22250	49-05	Christian	0.80	0.13	0.18	0.32	0.04	0.28	6.58	748	56	25	43	17
R22251	49-07	Christian	0.87	0.15	0.06	0.16	0.04	0.12	6.55	688	37	26	37	18
R22252	49-21	Christian	0.59	0.10	0.09	0.17	0.03	0.14	6.81	531	48	27	28	16
R22276	54-01	Christian	0.73	0.21	0.09	2.70	0.19	2.51	7.08	551	49	29	32	18
R22277	54-03	Christian	0.75	0.10	0.15	1.04	0.03	1.01	6.36	634	115	32	44	25
R22278	54-04	Christian	0.76	0.09	0.12	0.53	0.03	0.50	6.33	617	64	34	46	28
R22279	54-05	Christian	0.77	0.09	0.09	0.34	0.04	0.30	6.76	548	81	29	41	26
R22280	54-07	Christian	0.61	0.10	0.04	2.44	2.39	0.05	7.87	414	12	20	12	9
R22281	54-14	Christian	0.79	0.10	0.03	0.45	0.04	0.41	7.32	327	645	31	29	27
R22162	36-01	Clark	0.90	0.11	0.24	0.91	0.05	0.86	5.92	890	25	21	33	12
R22163	36-02	Clark	0.90	0.08	0.12	0.39	0.04	0.35	6.22	905	39	22	30	7
R22164	36-03	Clark	0.88	0.08	0.05	0.25	0.04	0.21	4.50	803	58	32	31	11
R22165	36-04	Clark	0.89	0.09	0.06	0.16	0.04	0.12	4.30	787	65	32	28	8
R22166	36-06	Clark	0.70	0.04	0.04	0.17	0.03	0.14	4.66	554	17	22	18	10
R22167	36-08	Clark	0.58	0.04	0.08	0.19	0.04	0.15	5.22	527	48	25	34	18
R22138	32-01	Clay	0.75	0.19	0.12	1.41	0.13	1.28	6.72	606	21	19	23	<5
R22139	32-02	Clay	0.80	0.10	0.13	1.02	0.13	0.89	5.28	640	23	19	23	<5
R22140	32-03	Clay	0.82	0.09	0.11	0.65	0.03	0.62	4.22	593	30	24	21	6
R22141	32-04	Clay	0.79	0.12	0.40	0.32	0.06	0.26	4.30	771	71	23	35	18
R22142	32-06	Clay	0.75	0.06	0.06	0.22	0.10	0.12	6.34	841	53	27	36	23
R22143	32-11	Clay	0.41	0.10	0.09	2.57	2.57	<0.01	7.93	481	<5	20	12	6
R22013	18-01	Clinton	0.70	0.13	0.07	1.50	0.06	1.44	6.73	579	6	19	18	<5
R22014	18-02	Clinton	0.71	0.09	0.06	0.96	0.03	0.93	6.76	560	7	20	25	<5
R22015	18-03	Clinton	0.75	0.06	0.06	0.70	0.01	0.69	6.62	635	<5	20	16	<5
R22016	18-04	Clinton	0.76	0.05	0.07	0.40	0.02	0.38	6.48	550	<5	19	15	<5
R22017	18-10	Clinton	0.73	0.18	0.09	0.05	0.01	0.04	6.34	1,030	71	32	55	33
R22018	18-16	Clinton	0.59	0.08	0.02	0.18	0.01	0.17	6.87	480	44	25	27	19
R22019	19-01	Clinton	0.59	0.16	0.20	3.38	1.99	1.39	6.92	461	<5	18	28	<5
R22020	19-02	Clinton	0.77	0.11	0.20	1.09	0.04	1.05	6.85	557	29	17	29	<5
R22021	19-03	Clinton	0.80	0.09	0.23	0.58	0.04	0.54	5.23	550	37	17	26	<5
R22022	19-04	Clinton	0.81	0.08	0.06	0.79	0.03	0.76	4.68	468	88	32	37	17
R22023	19-05	Clinton	0.79	0.09	0.04	0.77	0.03	0.74	4.80	558	95	40	35	17
R22024	19-13	Clinton	0.68	0.09	0.08	0.18	0.04	0.14	7.54	516	47	24	32	14
R22173	37-01	Coles	0.84	0.17	0.15	1.49	0.04	1.45	6.24	763	55	19	28	7

Continued on next page

Electronic Filing: Received, Clerk's Office 3/24/2022

Lab no.	Sample ID	County	TiO <sub>2</sub> (%)	P <sub>2</sub> O <sub>5</sub> (%)	MnO (%)	Tot. C (%)	Inc. C (%)	Org. C (%)	pH	Ba	Cr	Cu	Hg (µg/g)	Ni
R22174	37-02	Coles	0.85	0.09	0.13	0.91	0.05	0.86	6.11	761	37	22	41	11
R22175	37-03	Coles	0.84	0.08	0.07	0.75	0.05	0.70	6.17	784	76	31	58	19
R22176	37-04	Coles	0.85	0.12	0.16	0.49	0.04	0.45	6.46	829	181	28	56	34
R22177	37-08	Coles	0.55	0.12	0.13	0.24	0.04	0.20	7.00	614	130	22	22	11
R22178	37-11	Coles	0.73	0.12	0.07	0.89	0.61	0.28	7.39	665	42	26	30	14
R22258	51-01	Coles	0.75	0.11	0.12	1.38	0.06	1.32	4.85	430	31	22	25	8
R22259	51-02	Coles	0.76	0.09	0.14	1.25	0.06	1.19	4.89	356	30	23	27	9
R22260	51-03	Coles	0.76	0.06	0.12	0.84	0.04	0.80	5.72	589	66	31	54	21
R22261	51-04	Coles	0.75	0.06	0.14	0.57	0.06	0.51	6.42	578	71	31	57	29
R22262	51-06	Coles	0.54	0.09	0.10	0.46	0.21	0.25	7.32	417	22	26	30	9
R22263	51-21	Coles	0.38	0.07	0.06	3.36	3.08	0.28	7.63	195	<5	20	17	<5
R23540	128-1	Cook	0.46	0.16	0.06	7.07	0.80	6.27	7.28	546	107	53	115	34
R23541	128-2	Cook	0.59	0.12	0.06	3.21	0.18	3.03	7.28	630	123	33	46	36
R23542	128-3	Cook	0.14	0.05	0.04	2.33	2.00	0.33	8.00	461	187	9	8	16
R23543	128-4	Cook	0.15	0.05	0.04	2.39	2.22	0.17	8.13	491	358	8	7	28
R23544	128-7	Cook	0.18	0.09	0.04	3.67	1.85	1.82	8.08	486	756	10	16	31
R23545	128-9	Cook	0.16	0.05	0.04	3.66	2.62	1.04	8.17	467	373	9	7	21
R23750	130-1	Cook	0.63	0.21	0.06	5.39	0.13	5.26	6.48	574	84	43	48	36
R23751	130-3	Cook	0.67	0.11	0.04	2.28	0.10	2.18	7.12	615	113	61	41	36
R23752	130-5	Cook	0.68	0.10	0.03	0.96	0.11	0.85	7.41	644	306	43	46	30
R23753	130-8	Cook	0.70	0.09	0.03	1.63	0.17	1.46	7.70	697	188	34	42	46
R23754	130-12	Cook	0.49	0.10	0.07	4.08	2.79	1.29	7.24	424	76	33	27	38
R23755	130-13	Cook	0.50	0.10	0.07	3.91	2.72	1.19	7.52	462	71	36	27	37
R22156	35-01	Crawford	0.76	0.26	0.12	0.96	0.04	0.92	5.99	727	10	22	27	7
R22157	35-02	Crawford	0.81	0.11	0.08	0.38	0.03	0.35	6.07	752	24	21	16	<5
R22158	35-03	Crawford	0.81	0.11	0.08	0.42	0.04	0.38	5.98	755	58	34	20	9
R22159	35-04	Crawford	0.80	0.11	0.10	0.40	0.02	0.38	6.03	778	66	34	39	12
R22160	35-06	Crawford	0.71	0.14	0.07	1.12	0.95	0.17	7.53	697	23	27	25	9
R22161	35-09	Crawford	0.67	0.08	0.05	0.16	0.08	0.08	6.76	659	5	25	28	14
R23528	126-1	DeKalb	0.69	0.21	0.10	3.48	0.15	3.33	6.22	686	77	25	45	28
R23529	126-2	DeKalb	0.69	0.16	0.03	2.87	0.13	2.74	6.51	771	81	28	42	33
R23530	126-3	DeKalb	0.70	0.14	0.05	1.19	0.06	1.13	6.68	733	78	31	64	37
R23531	126-5	DeKalb	0.69	0.14	0.37	0.49	0.05	0.44	7.34	936	290	32	51	66
R23532	126-7	DeKalb	0.68	0.17	0.18	0.39	0.06	0.33	7.59	832	279	27	41	38
R23533	126-11	DeKalb	0.35	0.10	0.07	3.66	3.42	0.24	8.31	420	60	17	17	21
R23774	134-1	DeKalb	0.72	0.26	0.17	2.55	0.23	3.32	6.80	753	122	23	34	22
R23775	134-2	DeKalb	0.72	0.10	0.10	1.04	0.08	0.96	5.81	751	109	23	50	27
R23776	134-3	DeKalb	0.70	0.11	0.11	0.69	0.09	0.60	5.59	676	382	28	55	41
R23777	134-4	DeKalb	0.68	0.11	0.12	0.52	0.08	0.44	5.87	701	94	28	39	34
R23778	134-5	DeKalb	0.59	0.11	0.11	0.47	0.14	0.33	6.82	681	144	28	40	61
R23779	134-6	DeKalb	0.38	0.08	0.06	3.96	3.94	0.02	8.22	404	82	20	18	27
R22264	52-1	Douglas	0.70	0.14	0.05	1.96	0.09	1.87	7.40	382	53	28	18	12
R22265	52-2	Douglas	0.74	0.08	0.06	0.85	0.04	0.81	7.24	464	ND	ND	27	ND
R22266	52-3	Douglas	0.71	0.10	0.05	0.97	0.05	0.92	6.91	469	54	30	34	14
R22267	52-5	Douglas	0.71	0.11	0.14	0.34	0.05	0.29	7.18	403	54	29	30	14
R22268	52-7	Douglas	0.78	0.10	0.19	0.40	0.22	0.18	7.74	547	41	24	14	10
R22269	52-14	Douglas	0.42	0.07	0.07	3.08	2.67	0.41	7.81	284	<5	26	6	<5
R22365	66-01	Douglas	0.71	0.10	0.15	1.14	0.04	1.10	5.34	346	109	27	11	22
R22366	66-02	Douglas	0.69	0.06	0.14	0.75	0.03	0.72	6.50	354	69	30	35	24
R22367	66-03	Douglas	0.67	0.06	0.14	0.52	0.03	0.49	7.05	389	109	30	38	29
R22368	66-04	Douglas	0.67	0.10	0.16	0.43	0.03	0.40	7.34	309	119	26	27	22
R22369	66-05	Douglas	0.63	0.11	0.13	0.57	0.31	0.26	7.52	265	79	27	19	16
R22370	66-06	Douglas	0.43	0.07	0.08	2.32	1.92	0.40	7.92	<100	25	24	8	8
R23744	129-1	DuPage	0.56	0.12	0.07	5.16	1.59	3.57	7.65	495	70	38	56	38
R23745	129-4	DuPage	0.51	0.09	0.08	5.27	2.51	2.76	7.65	405	110	36	39	42
R23746	129-5	DuPage	0.54	0.21	0.03	14.16	0.18	13.98	6.32	559	58	76	109	57
R23747	129-6	DuPage	0.66	0.13	0.04	4.37	0.15	4.22	6.82	735	78	43	54	67
R23748	129-7	DuPage	0.55	0.13	0.04	3.14	1.86	1.28	7.57	548	136	27	29	47

Continued on next page

Electronic Filing: Received, Clerk's Office 3/24/2022

Lab no.	Sample ID	County	TiO <sub>2</sub> (%)	P <sub>2</sub> O <sub>5</sub> (%)	MnO (%)	Tot. C (%)	Inc. C (%)	Org. C (%)	pH	Ba	Cr	Cu	Hg (µg/g)	Ni
R23749	129-11	DuPage	0.47	0.09	0.08	4.41	3.42	0.99	7.91	366	82	30	22	38
R22204	67-01	Edgar	0.51	0.11	0.12	1.60	0.83	0.77	7.78	<100	48	26	17	11
R22205	67-02	Edgar	0.70	0.15	0.17	1.89	0.06	1.83	7.31	222	48	23	25	10
R22206	67-03	Edgar	0.75	0.12	0.19	1.58	0.03	1.55	6.84	286	41	22	22	11
R22207	67-05	Edgar	0.69	0.07	0.15	0.72	0.05	0.67	5.67	225	75	31	53	21
R22208	67-07	Edgar	0.60	0.05	0.13	0.54	0.05	0.49	6.44	240	68	30	25	23
R22209	67-09	Edgar	0.34	0.07	0.07	3.00	2.81	0.19	8.22	90	<5	20	3	<5
R22037	22-01	Edwards	0.66	0.17	0.10	2.62	0.10	2.52	6.58	435	<5	20	43	<5
R22038	22-02	Edwards	0.60	0.10	0.10	0.61	0.07	0.54	6.77	398	<5	17	30	<5
R22039	22-03	Edwards	0.64	0.08	0.07	0.38	0.02	0.36	6.66	424	<5	19	25	<5
R22040	22-04	Edwards	0.57	0.07	0.14	0.38	0.02	0.36	6.74	324	<5	18	24	<5
R22041	22-08	Edwards	0.66	0.05	0.02	0.26	0.04	0.22	6.36	450	<5	19	16	<5
R22042	22-14	Edwards	0.30	0.08	0.04	0.14	0.03	0.11	6.80	253	19	22	16	13
R22049	24-01	Edwards	0.88	0.11	0.16	1.13	0.04	1.09	5.42	584	ND	ND	34	ND
R22050	24-02	Edwards	0.91	0.07	0.10	0.55	0.04	0.51	6.02	581	28	24	34	6
R22051	24-03	Edwards	0.89	0.08	0.05	0.39	0.04	0.35	6.00	638	56	30	54	7
R22052	24-04	Edwards	0.89	0.09	0.05	0.32	0.04	0.28	5.48	556	69	33	78	7
R22053	24-10	Edwards	0.72	0.06	0.03	0.18	0.03	0.15	5.72	382	39	27	10	21
R22054	24-16	Edwards	0.75	0.06	0.04	0.18	0.03	0.15	6.42	324	40	22	27	9
R22185	39-1/2	Effingham	0.80	0.09	0.22	0.88	0.07	0.81	6.24	610	73	18	34	8
R22186	39-03	Effingham	0.81	0.06	0.04	0.42	0.04	0.38	4.02	483	89	32	89	13
R22187	39-04	Effingham	0.81	0.09	0.04	0.43	0.04	0.39	3.98	444	62	37	28	15
R22188	39-05	Effingham	0.83	0.10	0.06	0.34	0.03	0.31	4.24	534	56	32	11	11
R22189	39-07	Effingham	0.71	0.08	0.03	0.31	0.03	0.28	4.38	596	44	26	11	15
R22190	39-13	Effingham	0.58	0.06	0.43	0.24	0.03	0.21	6.50	705	86	18	38	18
R22116	30-01	Fayette	0.77	0.13	0.21	1.19	0.04	1.15	6.20	627	13	20	20	10
R22117	30-02	Fayette	0.82	0.10	0.10	0.50	0.04	0.46	4.52	605	31	20	18	9
R22118	30-03	Fayette	0.87	0.11	0.06	0.34	0.04	0.30	4.42	557	49	28	21	9
R22119	30-04	Fayette	0.78	0.11	0.06	0.27	0.04	0.23	4.20	555	57	34	20	15
R22120	30-08	Fayette	0.40	0.02	0.02	0.19	0.03	0.16	5.70	303	12	25	15	22
R22121	31-01	Fayette	0.69	0.12	0.02	1.38	0.03	1.35	4.38	425	50	27	31	19
R22122	31-02	Fayette	0.72	0.05	0.02	0.60	0.04	0.56	4.44	439	63	34	48	20
R22123	31-03	Fayette	0.62	0.04	0.03	0.24	0.03	0.21	6.08	647	34	26	39	29
R22124	31-04	Fayette	0.45	0.09	0.03	0.20	0.04	0.16	6.82	325	31	30	22	19
R22125	31-08	Fayette	0.41	0.06	0.03	0.29	0.20	0.09	7.61	289	7	25	20	13
R22126	31-20	Fayette	0.59	0.08	0.05	2.36	1.64	0.72	7.28	416	6	25	19	12
R22191	40-01	Fayette	0.77	0.11	0.27	3.65	0.05	3.60	5.84	314	20	19	37	9
R22192	40-02	Fayette	0.84	0.10	0.26	0.61	0.05	0.56	4.38	651	27	18	28	7
R22193	40-03	Fayette	0.82	0.09	0.10	0.43	0.04	0.39	4.53	569	43	23	27	8
R22194	40-04	Fayette	0.83	0.09	0.06	0.37	0.03	0.34	4.24	542	73	29	62	10
R22195	40-07	Fayette	0.79	0.13	0.06	0.29	0.04	0.25	4.19	703	75	36	14	12
R22196	40-14	Fayette	0.60	0.04	0.06	0.21	0.03	0.18	6.52	530	82	22	36	15
R22197	41-01	Fayette	0.78	0.10	0.39	1.15	0.05	1.10	6.98	672	37	19	34	9
R22198	41-02	Fayette	0.81	0.09	0.30	1.07	0.04	1.03	6.74	628	29	20	28	10
R22199	41-03	Fayette	0.84	0.08	0.22	0.84	0.04	0.80	5.22	596	46	20	27	9
R22200	41-04	Fayette	0.88	0.08	0.04	0.73	0.03	0.70	4.54	628	62	31	22	13
R22201	41-09	Fayette	0.75	0.06	0.06	0.27	0.02	0.25	6.87	534	24	24	33	10
R22202	41-23	Fayette	0.55	0.09	0.04	2.21	1.80	0.41	8.02	862	21	26	17	9
R23071	89-01	Ford	0.58	0.17	0.09	2.83	0.17	2.66	5.74	453	87	27	30	26
R23072	89-02	Ford	0.64	0.05	0.06	0.94	0.08	0.86	6.08	497	133	27	31	29
R23073	89-03	Ford	0.62	0.07	0.05	0.59	0.07	0.52	6.38	447	83	37	59	38
R23074	89-04	Ford	0.61	0.10	0.07	0.39	0.07	0.32	6.72	449	127	34	44	53
R23075	89-05	Ford	0.40	0.09	0.04	0.34	0.06	0.28	7.54	282	126	22	15	29
R23076	89-07	Ford	0.26	0.08	0.30	1.36	1.18	0.18	8.10	353	32	27	15	38
R22127	11-01	Franklin	0.79	0.10	0.10	1.39	0.05	1.34	5.42	416	47	24	25	21
R22128	11-02	Franklin	0.90	0.10	0.10	0.70	0.04	0.66	5.12	521	12	21	29	6
R22129	11-03	Franklin	0.87	0.09	0.09	0.63	0.04	0.59	4.86	555	15	22	24	6
R22130	11-05	Franklin	0.85	0.08	0.07	0.55	0.03	0.52	4.64	515	32	26	26	13

Continued on next page

Electronic Filing: Received, Clerk's Office 3/24/2022

Lab no.	Sample ID	County	TiO <sub>2</sub> (%)	P <sub>2</sub> O <sub>5</sub> (%)	MnO (%)	Tot. C (%)	Inc. C (%)	Org. C (%)	pH	Ba	Cr	Cu	Hg (µg/g)	Ni
R22131	11-06	Franklin	0.82	0.07	0.15	0.15	0.03	0.12	4.83	582	8	18	30	8
R22132	11-34	Franklin	0.68	0.11	0.03	0.49	0.03	0.46	4.90	539	9	20	26	7
R23011	79-01	Fulton	0.85	0.15	0.25	1.54	0.12	1.42	5.00	684	50	19	30	24
R23012	79-02	Fulton	0.88	0.10	0.17	0.59	0.09	0.50	6.36	619	52	19	25	20
R23013	79-03	Fulton	0.86	0.11	0.10	0.47	0.09	0.39	6.48	618	78	25	35	24
R23014	79-04	Fulton	0.84	0.12	0.06	0.39	0.09	0.30	5.50	517	81	33	32	31
R23015	79-06	Fulton	0.86	0.12	0.08	0.30	0.11	0.19	5.26	457	83	34	33	46
R23016	79-11	Fulton	0.71	0.14	0.08	2.19	1.97	0.22	7.32	399	72	27	21	29
R23041	84-01	Fulton	0.79	0.09	0.12	0.94	0.09	0.85	6.36	640	84	22	33	30
R23042	84-02	Fulton	0.80	0.12	0.08	0.41	0.10	0.31	5.56	569	232	29	72	39
R23043	84-03	Fulton	0.76	0.13	0.07	0.33	0.07	0.26	4.87	511	88	31	28	40
R23044	84-05	Fulton	0.77	0.13	0.06	0.23	0.07	0.16	4.44	501	108	27	18	33
R23045	84-09	Fulton	0.26	0.07	0.05	0.19	0.07	0.12	5.58	232	101	17	16	57
R23046	84-14	Fulton	0.36	0.08	0.05	0.21	0.07	0.14	5.55	270	48	20	19	24
R23047	85-01	Fulton	0.69	0.15	0.16	0.73	0.08	0.65	7.32	683	119	19	33	34
R23048	85-02	Fulton	0.68	0.13	0.09	0.41	0.05	0.36	7.46	328	129	28	40	44
R23049	85-03	Fulton	0.68	0.12	0.08	0.36	0.09	0.27	6.98	509	90	30	31	32
R23050	85-05	Fulton	0.66	0.12	0.08	0.31	0.07	0.24	6.96	532	378	33	27	51
R23051	85-09	Fulton	0.65	0.11	0.10	0.40	0.08	0.32	7.29	487	62	27	25	43
R23052	85-13	Fulton	0.55	0.10	0.07	2.36	2.17	0.19	8.26	330	48	21	16	27
R22228	46-01	Greene	0.75	0.14	0.06	1.73	0.06	1.67	6.20	583	30	27	24	7
R22229	46-02	Greene	0.76	0.11	0.06	1.66	0.05	1.61	6.26	637	20	27	23	9
R22230	46-04	Greene	0.76	0.07	0.04	1.27	0.05	1.22	6.06	651	31	30	21	9
R22231	46-05	Greene	0.76	0.07	0.03	0.99	0.05	0.94	6.17	629	155	33	25	13
R22232	46-08	Greene	0.77	0.14	0.10	0.31	0.06	0.25	6.25	650	90	32	41	15
R22233	46-33	Greene	0.54	0.10	0.02	0.14	0.04	0.10	6.23	455	15	30	27	11
R23190	103-1	Grundy	0.59	0.22	0.05	4.04	0.20	3.84	7.47	465	633	31	80	38
R23191	103-2	Grundy	0.62	0.15	0.05	2.79	0.12	2.67	7.22	538	218	22	72	39
R23192	103-3	Grundy	0.66	0.12	0.07	1.39	0.14	1.25	7.50	587	181	23	54	59
R23193	103-4	Grundy	0.38	0.08	0.06	4.49	4.24	0.25	8.02	333	149	18	43	23
R23194	103-5	Grundy	0.61	0.13	0.14	1.38	0.74	0.64	7.81	606	297	28	56	44
R22133	12-02	Hamilton	0.74	0.17	0.06	1.15	0.06	1.09	6.31	458	60	32	23	16
R22134	12-03	Hamilton	0.74	0.10	0.07	0.66	0.05	0.61	6.48	493	63	30	23	15
R22135	12-04	Hamilton	0.72	0.09	0.08	0.60	0.05	0.55	6.50	517	57	27	23	13
R22136	12-06	Hamilton	0.75	0.09	0.11	0.46	0.04	0.42	6.68	515	54	27	24	17
R22137	12-19	Hamilton	0.80	0.11	0.06	0.27	0.05	0.22	7.05	442	41	26	24	12
R22203	12-27	Hamilton	0.80	0.13	0.06	1.54	1.15	0.39	7.78	633	51	35	26	11
R23023	81-01	Hancock	0.79	0.16	0.08	2.65	0.56	2.09	7.24	529	64	20	29	22
R23024	81-02	Hancock	0.87	0.09	0.09	1.36	0.11	1.25	6.94	594	113	24	26	28
R23025	81-03	Hancock	0.87	0.06	0.12	0.78	0.11	0.67	6.37	581	109	32	50	49
R23026	81-05	Hancock	0.80	0.04	0.08	0.35	0.05	0.30	6.62	479	176	27	39	42
R23027	81-07	Hancock	0.77	0.06	0.04	0.35	0.08	0.27	7.05	471	71	29	45	34
R23028	81-13	Hancock	0.70	0.07	0.05	0.20	0.08	0.12	7.52	471	140	27	41	47
R23029	82-01	Hancock	0.70	0.17	0.11	2.60	0.07	2.53	6.61	714	72	23	117	26
R23030	82-02	Hancock	0.73	0.11	0.10	0.81	0.08	0.73	5.00	689	120	28	43	31
R23031	82-03	Hancock	0.73	0.14	0.10	1.50	0.16	1.34	5.26	648	58	22	55	24
R23032	82-04	Hancock	0.75	0.14	0.13	0.41	0.14	0.27	5.45	670	76	31	48	37
R23033	82-09	Hancock	0.85	0.18	0.17	0.29	0.10	0.19	6.97	769	74	32	34	57
R23034	82-13	Hancock	0.78	0.17	0.06	1.24	1.11	0.13	7.77	490	58	21	20	24
R23344	107-1	Henry	0.74	0.15	0.09	1.42	0.11	1.31	5.79	629	146	33	42	34
R23345	107-2	Henry	0.75	0.10	0.08	0.56	0.07	0.49	6.62	547	162	33	39	38
R23346	107-3	Henry	0.76	0.09	0.08	0.45	0.08	0.37	6.62	602	93	29	35	34
R23347	107-4	Henry	0.77	0.10	0.09	0.50	0.06	0.44	6.44	604	86	30	33	34
R23348	107-6	Henry	0.80	0.09	0.09	0.47	0.10	0.37	6.52	562	79	28	22	35
R23349	107-9	Henry	0.65	0.06	0.05	0.40	0.09	0.31	6.14	411	132	30	39	43
R23350	108-1	Henry	0.66	0.17	0.12	4.13	0.15	3.98	5.84	606	60	28	30	26
R23351	108-2	Henry	0.69	0.12	0.15	2.59	0.09	2.50	5.68	674	81	28	40	29
R23352	108-3	Henry	0.70	0.10	0.11	1.50	0.06	1.44	5.76	695	116	32	54	31

Continued on next page

Electronic Filing: Received, Clerk's Office 3/24/2022

Lab no.	Sample ID	County	TiO <sub>2</sub> (%)	P <sub>2</sub> O <sub>5</sub> (%)	MnO (%)	Tot. C (%)	Inc. C (%)	Org. C (%)	pH	Ba	Cr	Cu	Hg (µg/g)	Ni
R23353	108-5	Henry	0.70	0.11	0.10	0.55	0.10	0.45	5.92	651	114	36	46	40
R23354	108-7	Henry	0.71	0.13	0.13	0.54	0.17	0.37	7.10	647	79	31	33	46
R23355	108-10	Henry	0.60	0.12	0.04	2.67	2.45	0.22	8.50	434	94	22	21	21
R23390	110-1	Henry	0.42	0.07	0.07	1.15	0.15	1.00	7.16	471	219	18	28	28
R23391	110-2	Henry	0.43	0.08	0.07	0.60	0.06	0.54	7.00	493	228	26	22	37
R23392	110-3	Henry	0.42	0.09	0.08	0.46	0.07	0.39	6.97	432	142	28	29	36
R23393	110-5	Henry	0.25	0.07	0.05	0.28	0.06	0.22	6.72	493	441	21	26	42
R23394	110-7	Henry	0.20	0.06	0.03	0.18	0.06	0.12	6.43	344	583	16	13	27
R23395	110-9	Henry	0.17	0.05	0.03	0.21	0.06	0.15	5.46	392	326	16	12	20
R23396	111-1	Henry	0.42	0.13	0.03	2.24	0.12	2.12	6.26	508	147	29	34	23
R23397	111-2	Henry	0.41	0.11	0.02	1.40	0.16	1.24	6.97	438	152	25	30	22
R23398	111-3	Henry	0.45	0.11	0.02	1.02	0.09	0.93	7.34	482	72	22	29	19
R23399	111-4	Henry	0.45	0.13	0.03	0.77	0.08	0.69	7.80	452	220	19	38	22
R23400	111-5	Henry	0.33	0.09	0.02	1.27	0.42	0.85	7.90	401	461	22	25	28
R23401	111-6	Henry	0.12	0.05	0.02	1.40	1.14	0.26	8.14	291	299	16	8	33
R23135	97-01	Iroquois	0.63	0.14	0.04	2.19	0.20	1.99	7.00	468	70	26	27	36
R23136	97-02	Iroquois	0.64	0.12	0.03	1.69	0.16	1.53	7.00	483	271	26	29	41
R23137	97-03	Iroquois	0.62	0.11	0.05	0.87	0.12	0.75	7.08	517	160	24	33	62
R23138	97-05	Iroquois	0.65	0.09	0.04	0.91	0.53	0.38	7.88	585	154	20	31	39
R23139	97-07	Iroquois	0.66	0.12	0.08	2.86	2.54	0.32	7.97	468	71	24	15	43
R23140	97-09	Iroquois	0.63	0.12	0.10	3.57	2.97	0.60	8.00	295	76	26	18	50
R23147	99-01	Iroquois	0.25	0.12	0.03	1.33	0.09	1.24	5.06	430	33	10	17	30
R23148	99-02	Iroquois	0.28	0.04	0.02	0.48	0.09	0.39	5.08	415	196	10	12	33
R23149	99-03	Iroquois	0.28	0.03	0.02	0.26	0.04	0.22	4.76	436	62	10	11	19
R23150	99-06	Iroquois	0.25	0.05	0.03	0.32	0.07	0.25	4.84	449	111	13	16	47
R23152	99-08	Iroquois	0.19	0.04	0.02	0.17	0.09	0.08	6.97	386	47	9	7	13
R23153	99-09	Iroquois	0.20	0.05	0.03	0.14	0.08	0.06	7.44	413	46	10	3	18
R23153	100-01	Iroquois	0.64	0.16	0.10	2.32	0.10	2.22	7.06	552	63	28	123	32
R23154	100-02	Iroquois	0.68	0.08	0.10	1.35	0.09	1.26	7.16	563	79	31	41	51
R23155	100-03	Iroquois	0.69	0.07	0.11	0.94	0.08	0.86	7.10	562	74	31	37	54
R23156	100-05	Iroquois	0.54	0.08	0.09	3.24	2.41	0.83	8.18	399	69	28	23	42
R23157	100-06	Iroquois	0.49	0.07	0.08	4.00	3.50	0.50	8.33	227	66	24	18	34
R23158	100-08	Iroquois	0.51	0.06	0.08	3.87	3.34	0.53	8.28	330	61	26	17	34
R23159	101-01	Iroquois	0.79	0.13	0.11	2.27	0.12	2.15	7.30	583	94	22	26	31
R23160	101-02	Iroquois	0.81	0.06	0.09	1.31	0.07	1.24	7.35	673	108	26	36	38
R23161	101-03	Iroquois	0.80	0.07	0.07	0.75	0.08	0.67	7.45	617	92	31	55	43
R23162	101-04	Iroquois	0.80	0.07	0.09	1.43	1.00	0.43	7.86	631	90	30	24	64
R23163	101-05	Iroquois	0.74	0.08	0.08	2.08	1.61	0.47	8.12	494	79	26	24	52
R23164	101-07	Iroquois	0.71	0.07	0.06	2.56	2.03	0.53	8.25	465	79	24	18	48
R21838	8-01	Jackson	0.56	0.15	0.07	7.79	2.57	5.22	7.28	370	62	31	40	24
R21839	8-02	Jackson	0.71	0.08	0.08	3.60	0.54	3.06	7.44	449	53	26	38	24
R21840	8-03	Jackson	0.73	0.06	0.08	0.50	0.02	0.48	7.34	459	67	24	29	26
R21841	8-06	Jackson	0.75	0.15	0.05	0.58	0.03	0.55	7.31	532	60	24	21	25
R21893	8-12	Jackson	0.60	0.19	0.30	0.19	0.03	0.16	7.40	733	54	25	19	24
R21894	8-22	Jackson	0.79	0.20	0.05	0.16	0.03	0.13	7.41	680	43	26	25	9
R22179	38-01	Jasper	0.87	0.17	0.08	1.22	0.18	1.04	6.81	601	25	22	23	7
R22180	38-02	Jasper	0.92	0.09	0.06	0.60	0.04	0.56	5.16	613	27	23	23	8
R22181	38-03	Jasper	0.81	0.08	0.08	0.53	0.03	0.50	4.70	602	35	22	20	9
R22182	38-05	Jasper	0.78	0.08	0.11	0.55	0.03	0.52	4.37	693	117	34	56	24
R22183	38-08	Jasper	0.61	0.06	0.03	0.20	0.03	0.17	6.57	469	87	25	27	17
R22184	38-13	Jasper	0.50	0.07	0.03	0.13	0.03	0.10	7.18	371	141	25	28	18
R22061	26-01	Jefferson	0.76	0.13	0.14	1.01	0.07	0.94	6.74	457	<5	19	28	7
R22062	26-02	Jefferson	0.74	0.06	0.08	0.33	0.03	0.30	5.05	445	9	20	23	<5
R22063	26-03	Jefferson	0.74	0.06	0.07	0.28	0.03	0.25	4.38	410	17	20	19	<5
R22064	26-04	Jefferson	0.68	0.07	0.08	0.24	0.04	0.20	4.36	403	15	22	27	<5
R22065	26-08	Jefferson	0.72	0.07	0.02	0.17	0.03	0.14	4.12	547	79	31	8	20
R22066	26-15	Jefferson	1.02	0.14	0.04	0.57	0.04	0.53	6.80	798	122	49	16	27
R22216	44-01	Jersey	0.77	0.10	0.21	0.83	0.05	0.78	6.33	667	15	18	24	7

Continued on next page



Electronic Filing: Received, Clerk's Office 3/24/2022

Lab no.	Sample ID	County	TiO <sub>2</sub> (%)	P <sub>2</sub> O <sub>5</sub> (%)	MnO (%)	Tot. C (%)	Inc. C (%)	Org. C (%)	pH	Ba	Cr	Cu	Hg (µg/g)	Ni
R22217	44-02	Jersey	0.80	0.10	0.10	0.40	0.04	0.36	5.40	704	40	20	30	7
R22218	44-03	Jersey	0.76	0.11	0.08	0.42	0.04	0.38	4.60	593	60	32	55	14
R22219	44-04	Jersey	0.76	0.10	0.12	0.32	0.03	0.29	4.58	579	55	29	35	15
R22220	44-13	Jersey	0.74	0.07	0.04	0.20	0.03	0.17	5.74	492	53	26	36	14
R22221	44-29	Jersey	0.40	0.07	0.06	2.87	2.77	0.10	7.86	279	<5	23	22	<5
R23461	119-1	Jo Daviess	0.68	0.11	0.15	2.24	0.26	1.98	6.88	635	60	18	33	21
R23462	119-2	Jo Daviess	0.71	0.10	0.18	1.62	0.11	1.51	6.76	866	54	21	37	27
R23463	119-3	Jo Daviess	0.71	0.08	0.15	0.99	0.10	0.89	6.98	791	110	19	38	36
R23464	119-5	Jo Daviess	0.73	0.10	0.08	0.59	0.07	0.52	7.28	734	94	21	35	37
R23465	119-6	Jo Daviess	0.74	0.12	0.06	0.40	0.07	0.33	7.48	773	89	20	31	36
R23466	119-11	Jo Daviess	0.60	0.16	0.06	2.89	2.62	0.27	8.32	621	56	14	12	26
R23467	120-1	Jo Daviess	0.67	0.22	0.13	2.00	0.58	1.42	7.51	710	57	21	40	26
R23468	120-2	Jo Daviess	0.68	0.13	0.12	1.20	0.28	0.92	7.22	666	91	22	46	26
R23469	120-4	Jo Daviess	0.67	0.12	0.07	0.48	0.07	0.41	6.72	686	90	27	51	30
R23470	120-5	Jo Daviess	0.68	0.14	0.13	0.56	0.06	0.50	6.74	706	99	27	52	37
R23471	120-8	Jo Daviess	0.74	0.15	0.08	0.45	0.08	0.37	6.98	680	94	25	27	39
R23472	120-15	Jo Daviess	0.82	0.12	0.04	0.51	0.09	0.42	6.83	799	71	20	39	28
R21766	3-01	Johnson	0.84	0.09	0.13	1.29	0.02	1.27	6.24	442	54	23	28	24
R21767	3-02	Johnson	0.85	0.05	0.10	0.33	0.02	0.31	6.56	454	89	26	25	37
R21768	3-03	Johnson	0.86	0.06	0.09	0.27	0.02	0.25	5.24	419	82	25	31	23
R21769	3-04	Johnson	0.87	0.07	0.06	0.20	0.02	0.18	4.22	472	58	29	41	26
R21770	3-05	Johnson	0.84	0.09	0.03	0.18	0.01	0.17	4.15	453	103	34	77	45
R21771	3-10	Johnson	0.82	0.33	0.09	0.15	0.01	0.14	6.04	594	62	27	19	34
R21772	3-14	Johnson	0.85	0.05	0.05	0.21	0.02	0.19	6.61	360	114	25	13	61
R23768	133-1	Kane	0.62	0.12	0.11	1.49	0.19	1.30	6.23	668	43	17	28	21
R23769	133-2	Kane	0.58	0.08	0.09	0.93	0.12	0.81	6.66	635	80	28	38	29
R23770	133-3	Kane	0.54	0.09	0.11	0.48	0.13	0.35	6.92	617	90	26	38	33
R23771	133-4	Kane	0.50	0.12	0.10	0.51	0.12	0.39	7.25	613	116	23	26	36
R23772	133-5	Kane	0.36	0.11	0.07	3.55	3.32	0.23	8.16	482	96	16	21	30
R23773	133-6	Kane	0.32	0.09	0.07	4.07	4.06	0.01	8.22	458	69	14	16	18
R23790	135-1	Kane	0.72	0.16	0.14	1.86	0.06	1.80	6.38	720	61	23	44	27
R23791	135-2	Kane	0.65	0.09	0.12	1.03	0.08	0.95	6.56	627	96	36	50	53
R23792	135-3	Kane	0.55	0.08	0.12	0.86	0.09	0.77	6.54	595	74	39	57	50
R23793	135-4	Kane	0.64	0.11	0.14	1.00	0.22	0.78	6.83	620	83	51	59	81
R23794	135-5	Kane	0.51	0.10	0.11	4.20	3.93	0.27	6.90	405	56	39	42	47
R23795	135-6	Kane	0.38	0.09	0.10	6.23	6.06	0.17	8.02	365	49	31	32	37
R23141	98-01	Kankakee	0.53	0.32	0.12	2.63	0.27	2.36	6.85	415	54	28	44	26
R23142	98-02	Kankakee	0.44	0.20	0.12	1.14	0.33	0.81	7.20	337	203	37	63	39
R23143	98-03	Kankakee	0.41	0.32	0.10	3.17	0.63	2.54	7.30	383	53	28	36	23
R23144	98-05	Kankakee	0.40	0.10	0.13	0.72	0.16	0.56	7.04	383	80	31	41	37
R23145	98-06	Kankakee	0.39	0.16	0.11	1.14	0.10	1.04	7.25	403	111	40	101	27
R23146	98-07	Kankakee	0.24	0.05	0.06	8.24	7.88	0.36	8.28	121	20	16	29	12
R23165	102-1	Kankakee	0.49	0.09	0.07	1.76	0.08	1.68	4.98	452	52	16	36	40
R23166	102-2	Kankakee	0.46	0.06	0.03	0.85	0.08	0.77	5.92	530	311	13	30	27
R23167	102-3	Kankakee	0.45	0.06	0.03	0.76	0.10	0.66	5.94	436	89	18	32	24
R23168	102-4	Kankakee	0.43	0.06	0.08	0.82	0.08	0.74	6.00	499	258	21	81	38
R23169	102-5	Kankakee	0.44	0.09	0.09	1.13	0.22	0.91	7.11	446	147	23	70	49
R23170	102-6	Kankakee	0.22	0.08	0.04	4.42	4.09	0.33	8.21	203	203	11	38	18
R23796	136-1	Kendall	0.69	0.31	0.17	3.55	0.47	3.08	6.02	785	62	24	50	26
R23797	136-4	Kendall	0.74	0.10	0.11	0.83	0.13	0.70	6.26	763	64	23	51	28
R23798	136-6	Kendall	0.66	0.10	0.13	0.56	0.10	0.46	5.48	658	120	32	46	40
R23799	136-8	Kendall	0.45	0.10	0.09	0.56	0.12	0.44	6.25	506	59	26	34	43
R23800	136-9	Kendall	0.37	0.10	0.08	4.14	3.86	0.28	8.08	388	47	26	25	27
R23801	136-10	Kendall	0.38	0.11	0.07	5.59	5.25	0.34	8.18	369	41	22	21	20
R23083	91-01	Knox	0.60	0.13	0.10	1.92	0.06	1.86	6.98	1,046	160	27	30	37
R23084	91-02	Knox	0.60	0.13	0.11	1.96	0.08	1.88	5.97	1,033	100	23	32	34
R23085	91-03	Knox	0.62	0.11	0.10	1.78	0.08	1.70	5.60	1,006	117	26	31	29
R23086	91-05	Knox	0.62	0.08	0.13	0.76	0.10	0.66	6.00	464	190	30	40	44

Continued on next page

Electronic Filing: Received, Clerk's Office 3/24/2022

Lab no.	Sample ID	County	TiO <sub>2</sub> (%)	P <sub>2</sub> O <sub>5</sub> (%)	MnO (%)	Tot. C (%)	Inc. C (%)	Org. C (%)	pH	Ba	Cr	Cu	Hg (µg/g)	Ni
R23087	91-07	Knox	0.64	0.12	0.12	0.34	0.05	0.29	7.04	456	92	30	35	52
R23088	91-11	Knox	0.62	0.13	0.08	1.15	1.03	0.12	8.05	372	123	22	20	39
R23756	131-1	Lake	0.55	0.11	0.12	3.37	2.07	1.30	7.92	412	111	32	27	43
R23757	131-3	Lake	0.66	0.09	0.17	1.59	0.68	0.91	7.57	454	81	46	39	71
R23758	131-4	Lake	0.61	0.11	0.09	3.24	2.84	0.40	8.16	390	87	36	23	44
R23759	131-5	Lake	0.53	0.10	0.08	4.45	4.34	0.11	8.18	373	63	31	19	41
R23760	131-6	Lake	0.53	0.09	0.08	4.27	4.03	0.24	8.19	425	61	28	18	42
R23761	131-7	Lake	0.52	0.09	0.07	4.51	4.17	0.34	8.17	408	68	30	17	36
R23195	104-1	LaSalle	0.67	0.12	0.08	2.76	0.29	2.47	7.78	664	206	28	45	27
R23196	104-2	LaSalle	0.71	0.09	0.09	1.93	0.13	1.80	7.40	597	126	22	70	29
R23197	104-3	LaSalle	0.71	0.07	0.07	0.95	0.07	0.88	7.42	625	104	26	87	39
R23198	104-4	LaSalle	0.69	0.09	0.09	0.66	0.13	0.53	7.35	547	133	33	95	67
R23199	104-6	LaSalle	0.56	0.12	0.08	2.38	2.12	0.26	7.97	494	139	26	63	36
R23200	104-8	LaSalle	0.47	0.11	0.08	3.48	3.31	0.17	7.40	438	108	26	29	30
R23414	114-1	LaSalle	0.66	0.34	0.10	3.25	0.22	3.03	6.60	664	89	30	58	23
R23415	114-2	LaSalle	0.67	0.20	0.07	1.65	0.14	1.51	6.72	674	58	29	46	20
R23416	114-3	LaSalle	0.66	0.14	0.12	0.98	0.09	0.89	7.22	763	86	32	59	36
R23417	114-4	LaSalle	0.66	0.16	0.14	0.59	0.13	0.46	7.41	722	126	30	53	53
R23418	114-5	LaSalle	0.65	0.18	0.14	0.66	0.30	0.36	7.76	710	78	30	37	44
R23419	114-6	LaSalle	0.55	0.16	0.09	2.62	2.07	0.55	8.42	484	119	26	24	29
R22150	34-01	Lawrence	0.86	0.12	0.23	1.54	0.11	1.43	6.09	907	<5	20	40	9
R22151	34-02	Lawrence	0.90	0.09	0.21	0.74	0.32	0.42	6.30	958	37	21	38	18
R22152	34-03	Lawrence	0.90	0.07	0.13	0.41	0.04	0.37	6.28	886	15	21	42	6
R22153	34-04	Lawrence	0.91	0.08	0.06	0.24	0.03	0.21	5.14	848	44	29	44	8
R22154	34-10	Lawrence	0.64	0.06	0.05	0.16	0.02	0.14	4.58	651	27	24	14	17
R22155	34-13	Lawrence	0.57	0.05	0.04	0.15	0.05	0.10	5.03	592	13	24	14	9
R23437	115-1	Lee	0.56	0.36	0.03	5.31	0.57	4.74	7.56	634	131	43	62	47
R23438	115-2	Lee	0.59	0.24	0.04	2.88	0.97	1.91	8.03	625	164	32	46	28
R23439	115-3	Lee	0.58	0.21	0.05	2.17	1.27	0.90	8.06	587	71	26	47	27
R23440	115-5	Lee	0.52	0.20	0.09	2.51	2.22	0.29	8.13	568	116	15	33	38
R23441	115-7	Lee	0.50	0.14	0.08	3.20	3.14	0.06	8.32	536	77	22	22	26
R23442	115-9	Lee	0.40	0.14	0.05	3.26	3.09	0.17	8.26	398	136	18	16	21
R23443	116-1	Lee	0.45	0.12	0.08	1.30	0.29	1.01	7.25	489	118	17	22	21
R23444	116-3	Lee	0.47	0.09	0.08	0.90	0.11	0.79	7.32	484	52	21	24	23
R23445	116-4	Lee	0.46	0.10	0.07	0.70	0.10	0.60	7.48	428	122	23	30	27
R23446	116-5	Lee	0.32	0.09	0.06	0.43	0.07	0.36	7.42	380	174	19	26	27
R23447	116-6	Lee	0.22	0.07	0.04	0.24	0.07	0.17	7.48	240	68	17	19	34
R23448	116-9	Lee	0.13	0.05	0.02	0.30	0.06	0.24	7.20	212	158	16	71	28
R23123	95-01	Livingston	0.51	0.17	0.09	2.59	0.09	2.50	7.13	<100	102	29	27	31
R23124	95-02	Livingston	0.51	0.08	0.09	2.28	0.07	2.21	6.72	375	121	28	26	31
R23125	95-03	Livingston	0.55	0.05	0.11	0.95	0.08	0.87	6.60	396	134	34	49	44
R23126	95-05	Livingston	0.56	0.08	0.12	0.54	0.05	0.49	6.64	407	135	36	45	62
R23127	95-08	Livingston	0.45	0.09	0.10	1.90	1.39	0.51	8.18	250	219	27	27	39
R23128	95-13	Livingston	0.53	0.06	0.06	3.78	3.05	0.73	8.30	238	86	29	18	47
R23129	96-01	Livingston	0.61	0.14	0.07	2.98	0.42	2.56	7.49	385	112	31	39	34
R23130	96-02	Livingston	0.55	0.09	0.20	1.33	0.46	0.87	7.74	397	92	47	58	64
R23131	96-03	Livingston	0.38	0.06	0.15	4.76	3.98	0.80	8.16	250	72	37	33	36
R23132	96-04	Livingston	0.46	0.06	0.12	3.36	2.66	0.70	8.24	252	84	42	37	46
R23133	96-07	Livingston	0.52	0.06	0.06	3.17	2.75	0.42	8.14	265	97	29	22	48
R23134	96-11	Livingston	0.53	0.06	0.07	3.47	2.84	0.63	8.10	246	73	29	17	48
R22347	64-01	Logan	0.67	0.14	0.13	2.07	0.04	2.03	6.38	224	52	27	16	15
R22348	64-02	Logan	0.66	0.12	0.12	1.92	0.03	1.89	5.92	241	40	27	16	15
R22349	64-03	Logan	0.72	0.10	0.11	1.35	0.03	1.32	5.85	338	144	30	22	19
R22350	64-06	Logan	0.69	0.13	0.12	0.54	0.09	0.45	6.74	338	51	29	18	18
R22351	64-08	Logan	0.52	0.10	0.08	2.67	2.35	0.32	7.52	173	5	24	9	8
R22352	64-22	Logan	0.61	0.07	0.03	0.13	0.04	0.09	7.00	283	160	26	12	28
R22686	74-01	Logan	0.73	0.23	0.06	3.13	0.08	3.05	7.10	1,216	35	23	28	13
R22687	74-03	Logan	0.76	0.14	0.11	1.68	0.04	1.69	7.04	1,012	328	21	29	23

Continued on next page



Electronic Filing: Received, Clerk's Office 3/24/2022

Lab no.	Sample ID	County	TiO <sub>2</sub> (%)	P <sub>2</sub> O <sub>5</sub> (%)	MnO (%)	Tot. C (%)	Inc. C (%)	Org. C (%)	pH	Ba	Cr	Cu	Hg (µg/g)	Ni
R22688	74-04	Logan	0.76	0.13	0.05	1.02	<0.01	0.94	7.51	1,055	140	20	33	32
R22689	74-05	Logan	0.75	0.14	0.22	0.73	0.07	0.66	7.74	1,084	72	17	47	22
R22690	74-07	Logan	0.73	0.14	0.07	1.35	0.42	0.93	7.95	1,100	113	21	32	18
R22691	74-11	Logan	0.52	0.12	0.08	3.15	2.90	0.25	8.11	612	<5	15	12	7
R22704	77-1	Logan	0.71	0.14	0.14	1.85	0.09	1.76	6.54	1,170	59	21	24	8
R22705	77-2	Logan	0.71	0.12	0.13	1.44	0.10	1.34	6.15	1,448	69	41	30	9
R22706	77-5	Logan	0.66	0.10	0.10	0.45	0.06	0.39	5.90	956	70	39	36	20
R22707	77-8	Logan	0.64	0.13	0.09	0.43	0.06	0.37	6.50	1,086	61	24	27	14
R22708	77-14	Logan	0.13	0.05	0.02	0.12	0.03	0.09	7.66	428	22	<5	6	16
R22709	77-26	Logan	0.71	0.14	0.04	0.35	0.04	0.31	8.17	723	64	53	29	9
R22692	75-01	Macon	0.83	0.14	0.17	1.75	0.05	1.70	6.26	792	39	16	39	9
R22693	75-02	Macon	0.78	0.09	0.10	1.19	0.05	1.14	5.46	971	70	20	37	13
R22694	75-03	Macon	0.71	0.06	0.09	0.80	0.05	0.75	5.96	890	165	22	44	20
R22695	75-04	Macon	0.70	0.07	0.10	0.70	0.05	0.65	6.58	782	135	24	43	22
R22696	75-06	Macon	0.67	0.11	0.11	0.49	0.18	0.31	7.68	574	51	21	26	17
R22697	75-10	Macon	0.37	0.06	0.05	2.52	2.36	0.16	8.17	347	<5	16	12	6
R22210	43-01	Macoupin	0.83	0.14	0.14	1.09	0.05	1.04	5.32	738	15	18	18	8
R22211	43-03	Macoupin	0.87	0.12	0.52	0.53	0.06	0.47	5.40	1,126	52	23	33	9
R22212	43-05	Macoupin	0.76	0.12	0.15	0.42	0.04	0.38	4.70	631	106	32	53	19
R22213	43-08	Macoupin	0.81	0.11	0.07	0.27	0.03	0.24	5.66	647	49	26	38	16
R22214	43-12	Macoupin	0.68	0.05	0.03	0.17	0.03	0.14	5.94	523	192	27	37	18
R22215	43-27	Macoupin	0.36	0.06	0.05	3.07	3.02	0.05	7.86	339	7	24	14	<5
R22234	47-01	Macoupin	0.71	0.11	0.09	0.91	0.05	0.86	6.94	557	20	24	21	8
R22235	47-02	Macoupin	0.76	0.10	0.09	0.77	0.07	0.70	7.48	575	14	24	22	8
R22236	47-04	Macoupin	0.58	0.09	0.08	0.61	0.04	0.57	7.30	552	23	20	19	8
R22237	47-05	Macoupin	0.72	0.10	0.08	0.70	0.07	0.63	4.57	599	15	23	22	9
R22238	47-08	Macoupin	0.63	0.09	0.10	0.44	0.03	0.41	6.80	547	25	23	13	10
R22239	47-16	Macoupin	0.66	0.11	0.06	0.41	0.06	0.35	6.87	524	112	30	9	18
R22104	28-01	Madison	0.65	0.10	0.06	1.16	0.04	1.12	6.82	562	<5	19	27	6
R22105	28-02	Madison	0.83	0.13	0.05	1.34	0.04	1.30	6.58	679	40	21	21	6
R22106	28-03	Madison	0.80	0.09	0.05	0.74	0.04	0.70	6.51	638	20	24	28	9
R22107	28-04	Madison	0.81	0.12	0.10	0.47	0.04	0.43	6.35	637	36	32	37	18
R22108	28-10	Madison	0.66	0.11	0.12	0.22	0.04	0.18	7.14	582	39	27	31	15
R22209	28-15	Madison	0.66	0.06	0.03	0.71	0.04	0.67	3.57	600	17	24	25	8
R22025	20-01	Marion	0.78	0.14	0.25	1.64	0.13	1.51	6.13	617	22	18	43	<5
R22026	20-02	Marion	0.86	0.10	0.18	0.27	0.03	0.24	4.18	588	33	18	35	<5
R22027	20-03	Marion	0.80	0.09	0.20	0.28	0.03	0.25	4.06	604	78	30	28	11
R22028	20-04	Marion	0.78	0.09	0.05	0.26	0.03	0.23	3.88	509	87	35	17	12
R22029	20-08	Marion	0.75	0.06	0.04	0.17	0.03	0.14	5.60	598	28	24	7	23
R22030	20-11	Marion	0.74	0.04	0.04	0.18	0.03	0.15	6.74	414	24	21	14	10
R22710	78-01	Mason	0.18	0.05	0.03	0.66	0.03	0.63	6.40	259	24	16	10	8
R22711	78-03	Mason	0.57	0.06	0.11	0.55	0.04	0.51	5.13	467	82	80	40	18
R22712	78-04	Mason	0.34	0.06	0.07	0.73	0.07	0.67	5.06	401	61	23	32	14
R22713	78-09	Mason	0.07	0.03	0.02	0.14	0.05	0.09	5.54	431	17	133	5	12
R22714	78-12	Mason	0.09	0.04	0.03	0.17	0.05	0.12	5.86	414	25	<5	9	13
R22715	78-17	Mason	0.10	0.04	0.03	1.44	1.39	0.05	8.71	273	16	<5	5	9
R23017	80-01	McDonough	0.52	0.10	0.09	2.16	1.28	0.88	7.55	259	124	19	20	22
R23018	80-04	McDonough	0.68	0.10	0.10	0.81	0.38	0.43	7.82	361	129	21	19	27
R23019	80-08	McDonough	0.54	0.09	0.11	1.17	0.75	0.42	7.76	300	68	20	18	26
R23020	80-10	McDonough	0.73	0.09	0.08	0.56	0.34	0.22	7.88	341	122	22	20	27
R23021	80-15	McDonough	0.82	0.13	0.08	1.01	0.09	0.92	7.46	483	59	23	27	29
R23022	80-20	McDonough	0.83	0.15	0.09	1.03	0.13	0.90	7.02	430	64	23	29	33
R23035	83-01	McDonough	0.79	0.19	0.11	2.87	0.11	2.76	6.16	579	16	24	32	24
R23036	83-02	McDonough	0.82	0.14	0.08	2.33	0.10	2.23	5.60	742	97	24	34	30
R23037	83-04	McDonough	0.82	0.11	0.12	0.42	0.11	0.31	6.10	790	84	27	56	39
R23038	83-05	McDonough	0.82	0.13	0.05	0.30	0.15	0.15	6.42	723	138	29	50	36
R23039	83-10	McDonough	0.85	0.15	0.08	0.70	0.61	0.09	8.03	594	62	27	28	32
R23040	83-14	McDonough	0.90	0.04	0.01	0.43	0.07	0.36	7.72	508	84	21	23	26

Continued on next page

Electronic Filing: Received, Clerk's Office 3/24/2022

Lab no.	Sample ID	County	TiO <sub>2</sub> (%)	P <sub>2</sub> O <sub>5</sub> (%)	MnO (%)	Tot. C (%)	Inc. C (%)	Org. C (%)	pH	Ba	Cr	Cu	Hg (µg/g)	Ni
R23762	132-1	McHenry	0.66	0.19	0.13	1.92	0.11	1.81	6.14	644	102	21	58	36
R23763	132-2	McHenry	0.59	0.10	0.10	0.77	0.12	0.65	7.07	651	112	30	39	42
R23764	132-3	McHenry	0.70	0.09	0.12	0.88	0.12	0.76	6.63	728	117	28	44	39
R23765	132-4	McHenry	0.49	0.11	0.08	0.63	0.08	0.55	7.15	568	227	30	34	47
R23766	132-5	McHenry	0.38	0.09	0.06	3.77	3.65	0.12	8.14	416	33	18	21	20
R23767	132-6	McHenry	0.45	0.10	0.07	4.81	4.75	0.06	8.20	398	33	17	18	16
R22674	72-01	McLean	0.76	0.15	0.10	2.73	0.08	2.65	5.29	779	83	18	35	10
R22675	72-02	McLean	0.76	0.09	0.08	1.25	0.09	1.16	6.18	751	171	49	22	18
R22676	72-03	McLean	0.76	0.11	0.06	0.61	0.06	0.55	6.66	991	93	23	56	19
R22677	72-04	McLean	0.75	0.15	0.09	0.58	0.09	0.49	6.92	992	222	24	48	21
R22678	72-06	McLean	0.74	0.15	0.11	0.44	0.10	0.34	7.53	889	48	21	36	16
R22679	72-09	McLean	0.50	0.10	0.08	1.19	1.04	0.15	7.98	497	57	17	18	8
R22680	73-01	McLean	0.77	0.18	0.15	2.05	0.10	1.95	6.26	753	28	15	28	8
R22681	73-02	McLean	0.76	0.10	0.10	1.32	0.08	1.24	6.58	884	116	21	39	16
R22682	73-03	McLean	0.74	0.07	0.10	0.85	0.06	0.79	6.68	705	77	24	48	21
R22683	73-04	McLean	0.79	0.08	0.12	0.62	0.08	0.54	6.90	1,015	146	23	41	23
R22684	73-05	McLean	0.79	0.14	0.10	0.46	0.09	0.37	7.54	1,250	200	24	34	31
R22685	73-06	McLean	0.73	0.14	0.10	1.07	0.80	0.27	7.93	1,211	51	19	27	15
R23065	88-01	McLean	0.62	0.17	0.11	2.59	0.07	2.52	7.05	401	118	33	65	33
R23066	88-02	McLean	0.66	0.10	0.11	1.86	0.04	1.82	6.84	511	79	27	31	31
R23067	88-03	McLean	0.64	0.08	0.10	0.86	0.03	0.83	6.92	518	84	33	45	40
R23068	88-05	McLean	0.64	0.07	0.10	0.53	0.04	0.49	6.82	462	103	33	39	44
R23069	88-07	McLean	0.44	0.11	0.18	1.00	0.30	0.70	7.09	352	138	39	49	52
R23070	88-08	McLean	0.26	0.07	0.11	4.75	4.55	0.20	7.74	139	50	26	34	22
R22270	53-01	Menard	0.76	0.14	0.05	4.07	0.06	4.01	5.25	277	55	30	48	23
R22271	53-02	Menard	0.88	0.15	0.05	2.68	0.06	2.62	5.60	937	120	29	28	19
R22272	53-03	Menard	0.92	0.15	0.06	0.91	0.06	0.85	6.22	1,000	29	21	48	11
R22273	53-04	Menard	0.95	0.19	0.10	0.54	0.06	0.48	7.09	1,019	66	32	36	41
R22274	53-05	Menard	0.93	0.19	0.05	1.34	1.01	0.33	7.68	861	86	27	25	19
R22275	53-11	Menard	0.41	0.07	0.08	2.49	2.37	0.12	8.04	328	106	20	13	<5
R22342	63-01	Menard	0.63	0.11	0.10	1.23	0.29	0.94	6.96	140	55	26	12	15
R22343	63-02	Menard	0.64	0.09	0.10	0.87	0.21	0.66	7.37	207	95	23	10	11
R22344	63-03	Menard	0.63	0.09	0.10	0.84	0.14	0.70	7.34	209	42	23	10	8
R22345	63-06	Menard	0.60	0.11	0.10	0.72	0.02	0.70	7.04	208	80	23	11	11
R22346	63-15	Menard	0.57	0.10	0.13	0.58	0.12	0.46	7.26	197	28	22	7	10
R23384	109-1	Mercer	0.72	0.11	0.09	1.75	0.18	1.57	7.20	497	174	28	35	33
R23385	109-3	Mercer	0.71	0.13	0.17	2.69	0.17	2.52	7.26	646	98	26	44	31
R23386	109-4	Mercer	0.71	0.14	0.16	2.77	0.16	2.61	7.40	694	63	26	44	31
R23387	109-5	Mercer	0.70	0.09	0.07	0.81	0.08	0.73	7.25	570	110	28	32	30
R23388	109-7	Mercer	0.60	0.09	0.08	1.10	0.26	0.84	7.57	457	106	26	35	31
R23389	109-9	Mercer	0.51	0.10	0.07	1.90	1.70	0.20	8.20	513	84	23	22	30
R22002	16-01	Monroe	0.77	0.13	0.11	1.15	0.04	1.11	6.45	539	60	29	36	8
R22003	16-02	Monroe	0.74	0.13	0.14	0.40	0.04	0.36	5.18	556	98	34	37	13
R22004	16-03	Monroe	0.69	0.15	0.50	0.32	0.04	0.28	5.78	1,015	113	33	55	43
R22005	16-04	Monroe	0.73	0.15	0.26	0.26	0.08	0.18	7.10	798	78	24	62	40
R22006	16-16	Monroe	0.71	0.09	0.12	0.12	0.11	0.01	6.89	640	50	23	36	17
R22007	16-26	Monroe	0.50	0.09	0.05	2.36	2.31	0.05	7.78	354	<5	22	9	<5
R22008	17-01	Monroe	0.59	0.33	0.10	1.85	0.07	1.78	6.36	791	58	32	45	6
R22009	17-02	Monroe	0.60	0.35	0.10	1.81	0.07	1.74	5.98	845	52	33	46	6
R22010	17-03	Monroe	0.59	0.27	0.09	1.36	0.08	1.28	5.78	827	58	30	35	11
R22011	17-04	Monroe	0.57	0.16	0.09	0.93	0.08	0.85	5.94	804	64	29	25	9
R22012	17-16	Monroe	0.46	0.15	0.05	0.27	0.07	0.20	6.62	843	169	22	20	7
R22204	42-01	Montgomery	0.53	0.10	0.11	1.36	0.03	1.33	6.06	502	60	26	28	8
R22205	42-02	Montgomery	0.56	0.11	0.13	1.61	0.03	1.58	6.32	527	6	23	28	10
R22206	42-04	Montgomery	0.56	0.07	0.12	0.66	0.03	0.63	6.53	496	ND	ND	26	ND
R22207	42-06	Montgomery	0.45	0.08	0.12	0.39	0.02	0.37	6.50	472	28	20	22	10
R22208	42-16	Montgomery	0.29	0.09	0.03	0.26	0.03	0.23	6.77	353	<5	20	15	13
R22209	42-23	Montgomery	0.83	0.11	0.03	0.30	0.03	0.27	5.78	663	89	31	27	12

Continued on next page

Electronic Filing: Received, Clerk's Office 3/24/2022

Lab no.	Sample ID	County	TiO <sub>2</sub> (%)	P <sub>2</sub> O <sub>5</sub> (%)	MnO (%)	Tot. C (%)	Inc. C (%)	Org. C (%)	pH	Ba	Cr	Cu	Hg (µg/g)	Ni
R22240	48-01	Montgomery	0.78	0.13	0.07	1.70	0.04	1.66	6.51	615	41	26	19	9
R22241	48-03	Montgomery	0.81	0.08	0.05	1.15	0.04	1.11	5.85	609	73	30	20	11
R22242	48-04	Montgomery	0.78	0.07	0.04	0.93	0.04	0.89	6.08	625	72	38	33	20
R22243	48-06	Montgomery	0.79	0.09	0.10	0.52	0.04	0.48	6.39	695	59	33	49	21
R22244	48-09	Montgomery	0.82	0.17	0.05	0.41	0.03	0.38	6.55	627	42	31	33	13
R22245	48-16	Montgomery	0.51	0.11	0.03	0.20	0.03	0.17	7.41	420	14	28	17	11
R22294	57-01	Morgan	0.77	0.27	0.12	1.06	0.07	0.99	5.36	724	20	23	17	8
R22295	57-02	Morgan	0.76	0.14	0.11	0.69	0.05	0.64	4.78	465	56	26	14	12
R22296	57-03	Morgan	0.78	0.14	0.09	0.75	0.05	0.70	4.96	592	68	31	40	19
R22297	57-05	Morgan	0.77	0.16	0.10	0.48	0.05	0.43	5.49	596	54	30	36	22
R22298	57-11	Morgan	0.79	0.16	0.09	0.25	0.03	0.22	6.06	194	45	24	19	14
R22299	57-16	Morgan	0.77	0.12	0.11	0.33	0.05	0.28	7.16	194	98	24	20	11
R23504	122-1*	Ogle	0.58	0.28	0.11	7.46	0.93	6.53	6.94	761	61	37	471	30
R23505	122-2*	Ogle	0.69	0.18	0.14	2.70	0.10	2.60	7.04	890	71	29	248	29
R23506	122-3*	Ogle	0.72	0.14	0.15	1.53	0.06	1.47	7.13	863	121	21	56	30
R23507	122-5	Ogle	0.68	0.11	0.13	0.55	0.09	0.46	6.40	801	138	24	48	32
R23508	122-8	Ogle	0.69	0.17	0.10	0.34	0.11	0.23	7.20	868	88	23	32	41
R23509	122-9	Ogle	0.62	0.12	0.10	2.25	2.01	0.24	7.92	622	60	19	29	26
R23510	123-1	Ogle	0.69	0.29	0.11	2.10	0.33	1.77	7.08	748	71	23	41	23
R23511	123-2	Ogle	0.71	0.13	0.10	1.06	0.08	0.98	6.86	834	83	26	42	36
R23512	123-3	Ogle	0.71	0.09	0.10	0.72	0.10	0.62	6.82	803	67	30	45	29
R23513	123-4	Ogle	0.79	0.06	0.06	0.60	0.07	0.53	6.74	822	69	29	98	48
R23514	123-7	Ogle	0.75	0.05	0.02	0.72	0.06	0.66	6.40	653	71	32	85	31
R23515	123-8	Ogle	0.73	0.05	0.02	0.69	0.08	0.61	6.44	609	86	34	43	37
R23089	92-01	Peoria	0.62	0.34	0.12	3.02	0.11	2.91	5.73	421	96	37	67	31
R23090	92-02	Peoria	0.78	0.19	0.10	1.53	0.09	1.44	5.52	588	77	32	43	40
R23091	92-03	Peoria	0.62	0.11	0.10	1.01	0.09	0.92	5.62	464	91	33	48	42
R23092	92-04	Peoria	0.64	0.10	0.10	0.59	0.09	0.50	5.96	421	97	32	39	43
R23093	92-06	Peoria	0.67	0.09	0.09	0.38	0.07	0.31	6.60	432	77	26	25	41
R23094	92-09	Peoria	0.60	0.13	0.07	1.69	1.46	0.23	7.87	317	126	21	24	30
R23095	93-01	Peoria	0.65	0.08	0.19	1.43	0.10	1.33	5.40	438	166	22	47	30
R23096	93-02	Peoria	0.63	0.06	0.10	0.50	0.08	0.42	5.36	470	123	26	29	32
R23097	93-03	Peoria	0.61	0.09	0.10	0.40	0.10	0.30	5.50	400	137	32	42	37
R23098	93-04	Peoria	0.60	0.11	0.08	0.36	0.08	0.28	5.74	391	118	37	37	44
R23099	93-06	Peoria	0.59	0.10	0.08	0.31	0.09	0.22	5.90	395	171	32	33	50
R23100	93-09	Peoria	0.36	0.09	0.05	2.92	2.89	0.03	8.21	291	103	22	18	29
R21895	9-01	Perry	0.76	0.21	0.32	1.71	0.05	1.66	7.22	824	29	25	104	6
R21896	9-02	Perry	0.82	0.10	0.26	0.31	0.03	0.28	7.07	739	24	19	68	<5
R21897	9-03	Perry	0.82	0.10	0.14	0.29	0.03	0.26	7.11	683	36	22	56	<5
R21898	9-07	Perry	0.76	0.12	0.12	0.18	0.03	0.15	3.84	785	100	28	22	16
R21899	9-12	Perry	0.75	0.10	0.03	0.17	0.03	0.14	5.68	775	28	25	61	17
R21900	9-20	Perry	0.59	0.21	0.04	0.17	0.02	0.15	5.88	398	45	33	37	35
R21901	10-01	Perry	0.78	0.07	0.07	0.74	0.03	0.71	5.56	738	61	29	31	15
R21902	10-02	Perry	0.78	0.06	0.08	0.33	0.02	0.31	6.92	699	45	27	14	11
R21903	10-03	Perry	0.77	0.05	0.06	0.17	0.02	0.15	6.75	579	42	22	10	12
R21904	10-05	Perry	0.71	0.11	0.06	0.10	0.02	0.08	7.12	481	36	19	26	8
R21905	10-10	Perry	0.75	0.06	0.09	0.12	0.02	0.10	6.74	494	77	23	29	13
R21906	10-16	Perry	0.61	0.09	0.02	0.09	0.02	0.07	7.04	422	36	22	25	7
R22222	45-01	Pike	0.77	0.10	0.13	1.24	0.05	1.19	6.33	622	22	20	24	8
R22223	45-02	Pike	0.81	0.08	0.09	0.45	0.05	0.40	5.40	673	37	26	30	9
R22224	45-03	Pike	0.79	0.09	0.09	0.33	0.05	0.28	4.60	555	69	33	33	14
R22225	45-05	Pike	0.80	0.12	0.09	0.16	0.05	0.11	4.58	604	66	35	19	16
R22226	45-09	Pike	0.85	0.13	0.10	0.20	0.05	0.15	5.74	686	70	27	31	12
R22227	45-17	Pike	0.88	0.04	0.02	0.64	0.06	0.58	7.86	432	88	38	6	32
R22300	58-01	Pike	0.72	0.16	0.16	1.34	0.18	1.16	7.56	376	13	18	11	7
R22301	58-02	Pike	0.75	0.07	0.06	0.40	0.03	0.37	7.56	320	47	20	25	5
R22302	58-03	Pike	0.65	0.13	0.03	0.42	0.06	0.36	7.18	200	90	32	37	48
R22303	58-04	Pike	0.66	0.13	0.03	0.39	0.04	0.35	6.52	138	87	34	39	18

Continued on next page

Electronic Filing: Received, Clerk's Office 3/24/2022

Lab no.	Sample ID	County	TiO <sub>2</sub> (%)	P <sub>2</sub> O <sub>5</sub> (%)	MnO (%)	Tot. C (%)	Inc. C (%)	Org. C (%)	pH	Ba	Cr	Cu	Hg (µg/g)	Ni
R22304	58-07	Pike	0.65	0.13	0.10	0.36	0.06	0.30	6.76	171	75	33	39	26
R22305	58-10	Pike	0.57	0.12	0.06	2.59	2.39	0.20	8.22	197	38	23	15	11
R22306	58-31	Pike	0.83	0.15	0.03	0.48	0.04	0.44	4.81	276	28	26	21	14
R22307	59-01	Pike	0.74	0.10	0.07	1.16	0.08	1.08	6.41	408	62	29	25	14
R22308	59-02	Pike	0.74	0.14	0.06	0.40	0.07	0.33	5.59	471	59	30	30	18
R22309	59-03	Pike	0.67	0.13	0.11	0.24	0.04	0.20	5.16	204	66	30	26	18
R22310	59-06	Pike	0.69	0.13	0.12	0.20	0.04	0.16	5.47	270	62	29	34	19
R22311	59-13	Pike	0.79	0.09	0.11	0.21	0.03	0.18	6.04	163	110	26	28	20
R22312	59-16	Pike	0.71	0.05	0.12	0.23	0.04	0.19	6.12	151	41	23	35	23
R21832	4-01	Pope	1.04	0.21	0.24	1.77	0.03	1.74	5.81	563	68	39	76	49
R21833	4-02	Pope	1.06	0.17	0.25	1.31	0.04	1.27	5.73	567	68	36	49	46
R21834	4-03	Pope	1.08	0.17	0.23	0.78	0.04	0.74	4.48	514	71	34	33	42
R21835	4-04	Pope	1.05	0.18	0.23	0.87	0.03	0.84	4.32	534	70	36	31	42
R21836	4-08	Pope	1.02	0.17	0.14	0.50	0.03	0.47	4.32	573	73	36	44	46
R21837	4-12	Pope	1.02	0.19	0.13	0.36	0.03	0.33	4.42	569	74	35	45	43
R21773	5-01	Pope	0.88	0.13	0.26	1.84	0.02	1.82	5.83	534	47	24	52	25
R21774	5-02	Pope	0.89	0.10	0.24	0.85	0.02	0.83	5.35	515	50	22	39	27
R21775	5-03	Pope	0.89	0.09	0.16	0.49	0.01	0.48	4.90	493	55	27	44	27
R21776	5-04	Pope	0.89	0.11	0.09	0.33	0.02	0.31	4.50	401	60	28	51	26
R21777	5-07	Pope	0.86	0.08	0.04	0.15	0.01	0.14	4.08	431	53	27	31	24
R21778	5-14	Pope	0.76	0.05	0.07	0.20	0.02	0.18	5.90	333	67	23	41	28
R21826	1-01	Pulaski	0.77	0.22	0.18	1.73	0.06	1.67	6.56	701	59	40	42	35
R21827	1-02	Pulaski	0.76	0.16	0.18	0.91	0.02	0.89	6.21	732	62	31	39	33
R21828	1-03	Pulaski	0.76	0.15	0.10	0.74	0.02	0.72	5.90	675	66	31	38	30
R21829	1-04	Pulaski	0.76	0.16	0.14	0.75	0.03	0.72	5.62	644	66	34	37	35
R21830	1-08	Pulaski	0.75	0.15	0.08	0.47	0.03	0.44	5.94	703	73	37	34	37
R21831	1-11	Pulaski	0.72	0.12	0.09	0.37	0.03	0.34	6.20	665	66	34	40	36
R23201	105-1	Putnam	0.69	0.24	0.14	1.97	0.14	1.83	5.13	574	191	26	54	28
R23202	105-2	Putnam	0.66	0.11	0.11	1.25	0.16	1.09	5.62	574	89	28	47	36
R23203	105-3	Putnam	0.65	0.09	0.10	0.79	0.15	0.64	5.76	604	97	32	61	43
R23204	105-5	Putnam	0.66	0.11	0.12	0.63	0.12	0.51	6.81	613	120	28	36	40
R23205	105-7	Putnam	0.50	0.08	0.06	3.10	2.84	0.26	8.29	446	140	27	28	40
R23206	105-12	Putnam	0.48	0.07	0.06	3.75	3.45	0.30	8.39	318	58	26	18	38
R22144	33-01	Richland	0.86	0.15	0.08	3.77	0.23	3.54	5.84	733	26	27	30	14
R22145	33-02	Richland	0.77	0.09	0.05	2.56	0.07	2.49	4.73	586	32	31	124	15
R22146	33-03	Richland	0.82	0.08	0.02	0.62	0.07	0.55	4.27	679	20	27	19	6
R22147	33-04	Richland	0.91	0.05	0.02	0.33	0.09	0.24	4.28	594	29	28	19	5
R22148	33-06	Richland	0.82	0.07	0.07	0.31	0.07	0.24	4.48	1,040	83	29	31	23
R22149	33-10	Richland	0.79	0.04	0.09	0.16	0.06	0.10	6.54	752	70	25	28	26
R21779	6-01	Saline	0.82	0.09	0.10	1.12	0.08	1.04	6.85	431	53	25	22	21
R21780	6-02	Saline	0.81	0.05	0.04	0.50	0.02	0.48	4.46	389	72	31	11	26
R21781	6-03	Saline	0.79	0.05	0.03	0.54	0.02	0.52	4.03	550	75	32	5	31
R21782	6-04	Saline	0.79	0.07	0.04	0.34	0.02	0.32	4.74	622	71	33	4	33
R21783	6-06	Saline	0.76	0.13	0.11	0.33	0.02	0.31	6.34	590	73	35	35	64
R21784	6-20	Saline	0.69	0.12	0.07	2.89	2.71	0.18	8.06	406	64	35	17	38
R22282	55-01	Sangamon	0.80	0.15	0.09	1.48	0.05	1.43	5.56	659	26	25	23	14
R22283	55-03	Sangamon	0.72	0.11	0.07	0.98	0.04	0.94	6.15	557	61	22	16	15
R22284	55-06	Sangamon	0.66	0.14	0.07	1.07	0.03	1.04	6.35	503	20	23	16	11
R22285	55-08	Sangamon	0.62	0.12	0.07	0.85	0.04	0.81	6.43	524	111	22	12	14
R22286	55-11	Sangamon	0.60	0.12	0.07	0.61	0.03	0.58	6.56	477	106	19	11	12
R22287	55-28	Sangamon	0.76	0.14	0.08	2.34	1.57	0.77	7.66	548	ND	ND	14	ND
R22288	56-01	Sangamon	0.71	0.16	0.09	3.20	0.06	3.14	5.55	590	106	30	24	16
R22289	56-02	Sangamon	0.72	0.12	0.07	3.01	0.04	2.97	6.06	573	54	25	17	14
R22290	56-03	Sangamon	0.76	0.12	0.19	2.03	0.05	1.98	6.28	684	63	21	21	16
R22291	56-05	Sangamon	0.75	0.17	0.78	0.64	0.04	0.60	6.82	1,315	100	24	47	28
R22292	56-07	Sangamon	0.78	0.22	0.36	0.35	0.04	0.31	7.47	1,079	56	22	35	15
R22293	56-11	Sangamon	0.75	0.23	0.05	0.50	0.28	0.22	7.69	662	63	24	31	11
R22252	50-01	Shelby	0.81	0.09	0.15	1.56	0.05	1.51	5.24	596	44	22	24	11

Continued on next page



## Electronic Filing: Received, Clerk's Office 3/24/2022

Lab no.	Sample ID	County	TiO <sub>2</sub> (%)	P <sub>2</sub> O <sub>5</sub> (%)	MnO (%)	Tot. C (%)	Inc. C (%)	Org. C (%)	pH	Ba	Cr	Cu	Hg (µg/g)	Ni
R22253	50-02	Shelby	0.83	0.07	0.09	1.02	0.05	0.97	5.29	640	51	30	31	17
R22254	50-03	Shelby	0.81	0.07	0.09	0.78	0.04	0.74	5.55	587	57	32	37	20
R22255	50-05	Shelby	0.59	0.07	0.09	0.42	0.10	0.32	7.01	349	44	27	28	15
R22256	50-07	Shelby	0.40	0.07	0.07	2.94	2.84	0.10	7.97	244	<5	22	13	<5
R22257	50-16	Shelby	0.38	0.08	0.06	3.35	2.96	0.39	7.62	197	<5	23	15	<5
R22098	27-1	St. Clair	0.73	0.12	0.17	1.15	0.05	1.10	6.11	745	9	19	27	6
R22099	27-2	St. Clair	0.73	0.10	0.14	0.65	0.03	0.62	6.42	758	18	21	21	6
R22100	27-3	St. Clair	0.75	0.10	0.18	0.57	0.03	0.54	6.41	828	43	24	28	9
R22101	27-4	St. Clair	0.70	0.14	0.08	0.46	0.03	0.43	5.60	658	70	32	37	18
R22102	27-9	St. Clair	0.69	0.18	0.11	0.98	0.79	0.19	7.64	741	39	27	31	15
R22103	27-13	St. Clair	0.71	0.16	0.03	0.69	0.57	0.12	7.61	620	26	24	25	8
R23498	121-1	Stephenson	0.68	0.25	0.13	2.65	0.52	2.13	6.99	728	68	23	29	20
R23499	121-2	Stephenson	0.70	0.09	0.11	1.43	0.08	1.35	6.89	774	59	14	28	22
R23500	121-3	Stephenson	0.71	0.11	0.14	1.78	0.09	1.69	6.74	820	100	17	28	27
R23501	121-5	Stephenson	0.70	0.15	0.14	2.49	0.08	2.41	6.52	911	76	18	34	27
R23502	121-8	Stephenson	0.72	0.10	0.13	0.93	0.08	0.85	6.13	844	97	23	41	33
R23503	121-10	Stephenson	0.71	0.12	0.13	0.40	0.08	0.32	6.70	860	77	24	38	39
R23053	86-01	Tazewell	0.64	0.14	0.21	1.55	0.17	1.38	7.30	564	90	21	31	30
R23054	86-02	Tazewell	0.66	0.09	0.24	0.66	0.07	0.59	5.64	578	223	23	18	32
R23055	86-03	Tazewell	0.61	0.08	0.10	0.62	0.06	0.56	5.09	472	180	34	32	38
R23056	86-05	Tazewell	0.61	0.09	0.11	0.43	0.06	0.37	6.00	474	96	32	38	53
R23057	86-07	Tazewell	0.63	0.14	0.13	0.23	0.08	0.15	6.26	609	70	37	43	50
R23058	86-12	Tazewell	0.54	0.11	0.10	2.15	1.93	0.22	8.05	434	53	22	16	32
R21759	2-01	Union	0.80	0.09	0.10	1.17	0.06	1.11	6.78	603	62	27	28	27
R21760	2-02	Union	0.80	0.15	0.08	0.46	0.02	0.44	6.60	573	86	30	31	46
R21761	2-03	Union	0.80	0.15	0.11	0.32	0.02	0.30	5.03	592	60	32	41	31
R21762	2-04	Union	0.80	0.14	0.09	0.20	0.02	0.17	4.84	567	60	31	42	29
R21763	2-06	Union	0.80	0.12	0.10	0.14	0.02	0.12	5.00	628	62	33	42	30
R21764	2-13	Union	0.78	0.13	0.10	0.19	0.02	0.17	6.38	634	57	27	20	31
R21765	2-26	Union	0.82	0.04	0.02	0.14	0.01	0.13	6.27	349	55	25	28	32
R22377	68-01	Vermilion	0.70	0.16	0.21	1.75	0.06	1.69	6.22	266	31	20	16	10
R22378	68-02	Vermilion	0.74	0.08	0.06	0.86	0.04	0.82	6.20	333	79	35	31	17
R22379	68-03	Vermilion	0.71	0.07	0.17	0.65	0.03	0.62	5.80	273	109	35	45	26
R22380	68-04	Vermilion	0.71	0.06	0.12	0.47	0.03	0.44	6.60	173	189	35	41	36
R22381	68-06	Vermilion	0.43	0.06	0.11	0.27	0.04	0.23	7.58	226	11	24	15	11
R22382	68-09	Vermilion	0.45	0.06	0.08	2.81	2.58	0.23	8.30	138	<5	22	<5	<5
R22506	69-01	Vermilion	0.71	0.19	0.50	2.90	0.05	2.85	4.88	226	81	47	33	10
R22507	69-03	Vermilion	0.60	0.10	<0.05	2.61	0.03	2.58	5.64	209	108	45	41	14
R22508	69-04	Vermilion	0.56	0.08	0.02	1.64	0.03	1.61	6.33	220	128	47	39	24
R22509	69-05	Vermilion	0.47	0.08	0.09	0.73	0.02	0.71	6.36	174	114	34	32	20
R22510	69-08	Vermilion	0.55	0.07	0.14	2.84	2.32	0.52	8.03	149	15	24	12	5
R22511	69-11	Vermilion	0.52	0.06	0.10	3.05	2.58	0.47	8.04	118	17	27	11	1
R22043	23-01	Wabash	0.78	0.13	0.13	1.99	0.34	1.65	6.88	521	13	22	30	<5
R22044	23-02	Wabash	0.81	0.09	0.06	1.12	0.05	1.07	6.80	511	10	20	30	10
R22045	23-03	Wabash	0.84	0.08	0.16	0.50	0.04	0.46	6.67	633	26	24	36	10
R22046	23-04	Wabash	0.83	0.09	0.08	0.33	0.03	0.30	6.02	633	68	31	33	11
R22047	23-08	Wabash	0.80	0.12	0.14	0.22	0.04	0.18	6.20	618	47	30	41	15
R22048	23-14	Wabash	0.74	0.05	0.07	0.17	0.03	0.14	6.84	402	51	22	32	12
R23077	90-01	Warren	0.56	0.14	0.12	2.50	0.36	2.14	7.46	534	106	23	35	24
R23078	90-02	Warren	0.60	0.10	0.17	1.61	0.04	1.57	6.80	589	104	23	35	29
R23079	90-03	Warren	0.60	0.08	0.10	0.77	0.05	0.72	6.60	515	84	27	46	30
R23080	90-05	Warren	0.55	0.12	0.15	0.41	0.04	0.37	5.97	528	74	30	45	42
R23081	90-07	Warren	0.57	0.15	0.14	0.39	0.04	0.35	6.27	547	90	28	38	44
R23082	90-11	Warren	0.50	0.13	0.09	1.69	1.58	0.11	8.15	397	56	26	20	32
R21990	14-01	Washington	0.79	0.14	0.35	1.97	0.05	1.92	5.86	640	21	23	20	6
R21991	14-02	Washington	0.82	0.12	0.39	1.23	0.03	1.20	6.37	685	35	20	29	<5
R21992	14-03	Washington	0.85	0.11	0.34	0.39	0.06	0.33	6.40	672	34	19	31	<5
R21993	14-04	Washington	0.81	0.10	0.09	0.25	0.04	0.21	4.28	649	68	25	41	8

Continued on next page

Electronic Filing: Received, Clerk's Office 3/24/2022

Lab no.	Sample ID	County	TiO <sub>2</sub> (%)	P <sub>2</sub> O <sub>5</sub> (%)	MnO (%)	Tot. C (%)	Inc. C (%)	Org. C (%)	pH	Ba	Cr	Cu	Hg (µg/g)	Ni
R21994	14-06	Washington	0.76	0.10	0.06	0.22	0.05	0.17	3.86	648	88	34	13	9
R21995	14-15	Washington	0.78	0.07	0.06	0.16	0.03	0.13	5.01	488	38	25	14	27
R21996	15-01	Washington	0.77	0.09	0.16	0.98	0.04	0.94	5.54	597	15	22	27	7
R21997	15-02	Washington	0.80	0.08	0.18	0.54	0.05	0.49	4.74	531	33	18	18	7
R21998	15-03	Washington	0.79	0.09	0.06	0.69	0.06	0.63		421	99	40	50	17
R21999	15-04	Washington	0.78	0.10	0.07	0.81	0.05	0.76	4.50	418	122	43	77	32
R22000	15-13	Washington	0.77	0.09	0.03	0.23	0.05	0.18	6.50	502	45	27	30	17
R22001	15-20	Washington	0.75	0.09	0.13	0.10	0.05	0.05	7.21	404	57	24	30	30
R22031	21-01	Wayne	0.83	0.15	0.04	1.99	0.03	1.96	5.14	471	29	27	37	8
R22032	21-02	Wayne	0.86	0.07	0.03	0.93	0.04	0.89	4.64	500	22	23	28	6
R22033	21-03	Wayne	0.90	0.08	0.04	0.48	0.03	0.45	4.45	467	29	23	23	<5
R22034	21-04	Wayne	0.85	0.08	0.02	0.54	0.04	0.50	4.21	418	100	32	48	27
R22035	21-07	Wayne	0.85	0.08	0.02	0.24	0.03	0.21	4.57	582	52	30	23	15
R22036	21-10	Wayne	0.90	0.09	0.04	0.26	0.04	0.22	5.12	558	58	29	29	26
R22055	25-01	Wayne	0.91	0.13	0.15	0.52	0.05	0.47	4.19	519	45	19	39	ND
R22056	25-02	Wayne	0.91	0.11	0.10	0.26	0.03	0.23	4.05	501	ND	ND	34	ND
R22057	25-03	Wayne	0.90	0.10	0.10	0.20	0.04	0.16	3.98	555	59	25	21	<5
R22058	25-04	Wayne	0.89	0.10	0.07	0.20	0.04	0.16	4.00	515	50	27	12	8
R22059	25-22	Wayne	0.84	0.13	0.19	0.32	0.10	0.22	7.42	733	71	27	35	15
R22060	25-29	Wayne	0.89	0.07	0.12	0.20	0.04	0.16	7.34	763	85	27	22	12
R21985	13-01	White	0.40	0.13	0.09	1.46	0.06	1.40	5.97	436	<5	24	92	<5
R21986	13-02	White	0.50	0.09	0.08	0.28	0.04	0.24	6.44	477	<5	20	23	<5
R21987	13-03	White	0.49	0.11	0.07	0.23	0.03	0.20	6.46	484	17	25	<2	<5
R21988	13-04	White	0.42	0.09	0.08	0.23	0.04	0.19	6.58	468	30	24	2	7
R21989	13-18	White	0.19	0.05	0.06	0.13	0.03	0.10	6.72	286	<5	21	<2	19
R23449	117-1	Whiteside	0.55	0.18	0.08	2.36	0.15	2.21	7.06	544	94	24	47	26
R23450	117-2	Whiteside	0.51	0.14	0.08	1.58	0.26	1.32	7.42	584	122	19	34	22
R23451	117-3	Whiteside	0.50	0.17	0.07	2.42	0.15	2.27	7.31	515	80	14	32	20
R23452	117-5	Whiteside	0.47	0.15	0.05	1.32	0.08	1.24	7.30	509	81	16	13	33
R23453	117-6	Whiteside	0.45	0.12	0.07	0.90	0.08	0.82	7.28	485	139	18	13	22
R23454	117-8	Whiteside	0.44	0.11	0.06	0.57	0.07	0.50	7.34	449	97	16	11	22
R23534	127-1	Will	0.74	0.11	0.09	2.97	0.11	2.86	6.88	645	71	28	36	31
R23535	127-3	Will	0.74	0.09	0.11	0.93	0.23	0.70	7.52	672	77	31	36	60
R23536	127-4	Will	0.62	0.10	0.07	2.59	2.06	0.53	8.06	599	72	27	24	42
R23537	127-5	Will	0.57	0.09	0.07	3.13	2.81	0.32	8.16	523	63	27	22	39
R23538	127-6	Will	0.59	0.10	0.08	2.99	2.78	0.21	8.18	500	63	27	21	44
R23539	127-7	Will	0.60	0.10	0.08	2.96	2.59	0.39	8.16	589	60	27	20	42
R23802	137-1	Will	0.71	0.18	0.13	2.20	0.17	2.05	7.32	692	73	23	29	29
R23803	137-2	Will	0.73	0.08	0.06	0.93	0.13	0.80	7.00	682	71	31	39	27
R23804	137-3	Will	0.70	0.08	0.08	0.68	0.14	0.54	6.87	671	90	37	46	32
R23805	137-4	Will	0.72	0.07	0.14	0.88	0.11	0.77	6.69	573	82	58	61	61
R23806	137-5	Will	0.70	0.08	0.09	0.91	0.11	0.80	7.04	654	84	61	61	70
R23807	137-6	Will	0.60	0.10	0.09	2.37	1.98	0.39	8.03	576	66	38	32	48
R21785	7-01	Williamson	0.83	0.12	0.20	1.97	0.11	1.86	6.48	552	55	24	60	27
R21786	7-02	Williamson	0.86	0.08	0.08	0.39	0.01	0.38	5.38	514	58	28	52	26
R21787	7-03	Williamson	0.86	0.08	0.05	0.29	0.01	0.28	4.14	492	63	29	59	26
R21788	7-06	Williamson	0.84	0.08	0.05	0.26	0.01	0.25	3.74	508	62	33	34	28
R21789	7-21	Williamson	0.84	0.05	0.03	0.09	0.01	0.08	5.83	389	49	25	23	23
R23516	124-1	Winnebago	0.38	0.11	0.06	1.17	0.17	1.00	7.10	396	183	21	26	24
R23517	124-2	Winnebago	0.36	0.07	0.06	0.64	0.17	0.47	7.60	529	340	20	20	27
R23518	124-3	Winnebago	0.28	0.07	0.04	2.90	2.64	0.26	8.14	388	59	17	15	18
R23519	124-4	Winnebago	0.25	0.07	0.04	3.85	3.61	0.24	8.38	353	40	13	19	12
R23520	124-5	Winnebago	0.24	0.06	0.04	4.01	3.85	0.16	8.50	361	47	14	20	12
R23521	124-7	Winnebago	0.24	0.06	0.03	3.97	3.91	0.06	8.54	310	58	11	11	11
R23059	87-01	Woodford	0.66	0.15	0.35	1.27	0.04	1.23	5.86	682	66	20	28	21
R23060	87-02	Woodford	0.66	0.12	0.27	1.00	0.05	0.95	6.12	606	43	16	28	20
R23061	87-03	Woodford	0.66	0.12	0.27	0.96	0.05	0.91	5.25	586	51	17	30	20
R23062	87-04	Woodford	0.69	0.10	0.12	0.51	0.05	0.46	5.42	550	151	32	46	48

Continued on next page

Electronic Filing: Received, Clerk's Office 3/24/2022

Lab no.	Sample ID	County	TiO <sub>2</sub> (%)	P <sub>2</sub> O <sub>5</sub> (%)	MnO (%)	Tot. C (%)	Inc. C (%)	Org. C (%)	pH	Ba	Cr	Cu	Hg (µg/g)	Ni
R23063	87-05	Woodford	0.70	0.14	0.11	0.37	0.03	0.34	6.82	538	74	32	39	49
R23064	87-06	Woodford	0.59	0.13	0.19	2.20	1.97	0.23	7.94	374	87	27	25	31
R23117	94-01	Woodford	0.57	0.17	0.11	3.13	0.25	2.88	7.39	362	115	32	28	28
R23118	94-02	Woodford	0.60	0.10	0.12	2.51	0.07	2.44	6.99	408	68	31	31	30
R23119	94-04	Woodford	0.57	0.06	0.10	1.02	0.06	0.96	7.27	451	84	27	42	49
R23120	94-06	Woodford	0.57	0.12	0.11	0.67	0.19	0.48	7.68	443	173	36	36	41
R23121	94-08	Woodford	0.45	0.11	0.08	3.05	3.00	0.05	8.07	134	124	28	18	30
R23122	94-12	Woodford	0.21	0.06	0.08	4.77	4.76	0.01	8.46	<10	26	23	11	51

*Continued on next page*



Electronic Filing: Received, Clerk's Office 3/24/2022

Lab. no.	Sample ID	County	Pb	Rb	Sr	V	Zn	Zr
R22313	60-01	Adams	27	61	144	63	69	380
R22314	60-02	Adams	18	67	173	64	54	443
R22315	60-03	Adams	16	61	160	69	36	440
R22316	60-06	Adams	22	86	138	107	96	286
R22317	60-21	Adams	24	72	64	84	54	319
R22318	60-40	Adams	16	63	118	72	57	205
R22110	29-01	Bond	28	53	123	71	65	368
R22111	29-02	Bond	20	57	119	78	55	383
R22112	29-03	Bond	17	56	120	79	43	386
R22113	29-04	Bond	22	70	109	108	65	310
R22114	29-09	Bond	13	52	117	62	37	308
R22115	29-14	Bond	15	40	65	56	32	148
R23522	125-1	Boone	23	84	165	73	71	418
R23523	125-2	Boone	20	78	157	82	72	380
R23524	125-3	Boone	20	80	163	96	59	460
R23525	125-4	Boone	19	79	162	111	77	409
R23526	125-6	Boone	12	52	125	53	30	260
R23527	125-10	Boone	13	70	112	50	50	138
R22329	61-01	Brown	18	56	132	68	54	375
R22330	61-02	Brown	21	92	107	108	97	309
R22331	61-03	Brown	24	89	128	102	101	332
R22332	61-04	Brown	17	65	119	94	76	326
R22333	61-10	Brown	14	58	202	78	52	432
R22334	61-18	Brown	19	68	108	83	52	346
R23338	106-1	Bureau	31	90	137	100	89	411
R23339	106-2	Bureau	22	86	129	114	82	377
R23340	106-3	Bureau	21	80	130	108	80	381
R23341	106-4	Bureau	18	66	151	88	77	397
R23342	106-6	Bureau	19	72	172	89	72	521
R23343	106-8	Bureau	17	60	138	68	59	381
R23402	112-1	Bureau	22	86	158	78	71	512
R23403	112-3	Bureau	20	83	158	103	61	446
R23404	112-4	Bureau	18	73	179	106	64	453
R23405	112-6	Bureau	18	67	219	99	60	485
R23406	112-8	Bureau	17	63	219	81	50	543
R23407	112-10	Bureau	16	66	210	83	54	486
R23408	113-1	Bureau	24	86	146	99	87	429
R23409	113-2	Bureau	20	78	148	117	78	378
R23410	113-3	Bureau	18	72	176	108	72	417
R23411	113-4	Bureau	21	70	176	94	68	445
R23412	113-5	Bureau	16	61	165	73	59	356
R23413	113-6	Bureau	14	57	153	59	58	290
R23455	118-1	Carroll	21	82	169	70	68	545
R23456	118-2	Carroll	18	91	153	96	66	439
R23457	118-3	Carroll	18	84	160	100	68	452
R23458	118-5	Carroll	18	74	188	104	67	479
R23459	118-8	Carroll	19	79	194	102	72	436
R23460	118-11	Carroll	17	76	188	87	68	497
R22335	62-01	Cass	9	36	96	<35	36	192
R22336	62-02	Cass	9	36	109	<35	28	174
R22337	62-03	Cass	9	36	99	<35	31	166
R22338	62-05	Cass	9	37	108	<35	27	184
R22339	62-07	Cass	9	39	97	<35	29	140
R22340	62-17	Cass	8	38	97	<35	34	86
R22341	62-18	Cass	8	34	100	<35	27	67
R22359	65-01	Champaign	20	64	111	78	56	373
R22360	65-02	Champaign	19	71	110	90	63	339
R22361	65-03	Champaign	22	75	108	107	82	301
R22362	65-04	Champaign	21	71	130	99	82	335

Continued on next page

Electronic Filing: Received, Clerk's Office 3/24/2022

Lab. no.	Sample ID	County	Pb	Rb	Sr	V	Zn	Zr
R22363	65-05	Champaign	19	66	135	87	74	354
R22364	65-11	Champaign	18	91	104	59	71	163
R22512	70-01	Champaign	21	99	105	77	81	272
R22513	70-02	Champaign	21	107	113	82	96	215
R22514	70-03	Champaign	21	101	118	83	97	235
R22515	70-04	Champaign	19	81	96	80	83	213
R22516	70-05	Champaign	19	84	114	77	81	218
R22517	70-08	Champaign	19	55	104	46	84	167
R22518	71-01	Champaign	38	67	120	73	90	320
R22519	71-02	Champaign	22	77	114	91	78	343
R22520	71-03	Champaign	19	66	137	94	78	358
R22521	71-04	Champaign	16	47	136	61	59	329
R22522	71-05	Champaign	15	40	148	53	57	286
R22523	71-10	Champaign	18	124	88	79	83	137
R22698	76-01	Champaign	16	56	114	64	50	323
R22699	76-03	Champaign	17	63	99	93	69	248
R22700	76-04	Champaign	15	52	118	86	58	272
R22701	76-05	Champaign	13	45	140	80	49	298
R22702	76-06	Champaign	13	42	121	78	48	280
R22703	76-08	Champaign	12	54	90	51	40	144
R22246	49-01	Christian	ND	ND	131	ND	ND	346
R22247	49-02	Christian	ND	ND	131	ND	ND	317
R22248	49-03	Christian	ND	ND	131	ND	ND	310
R22250	49-05	Christian	18	54	133	84	66	322
R22251	49-07	Christian	16	63	182	76	60	401
R22252	49-21	Christian	19	71	123	75	64	237
R22276	54-01	Christian	41	65	112	77	108	299
R22277	54-03	Christian	21	64	90	98	73	284
R22278	54-04	Christian	22	68	106	94	84	299
R22279	54-05	Christian	21	66	118	89	78	304
R22280	54-07	Christian	15	54	117	52	57	297
R22281	54-14	Christian	18	52	157	80	41	343
R22162	36-01	Clark	20	60	98	71	52	388
R22163	36-02	Clark	18	69	97	87	54	343
R22164	36-03	Clark	22	87	98	100	76	321
R22165	36-04	Clark	23	83	98	99	73	313
R22166	36-06	Clark	13	60	113	66	43	310
R22167	36-08	Clark	19	75	74	87	53	194
R22138	32-01	Clay	18	55	112	66	46	382
R22139	32-02	Clay	16	63	104	78	38	348
R22140	32-03	Clay	17	72	105	81	44	354
R22141	32-04	Clay	16	66	114	101	59	295
R22142	32-06	Clay	15	77	115	87	59	257
R22143	32-11	Clay	14	58	116	62	57	158
R22013	18-01	Clinton	18	56	135	56	47	425
R22014	18-02	Clinton	18	58	135	56	44	435
R22015	18-03	Clinton	13	59	137	59	36	420
R22016	18-04	Clinton	14	57	138	64	33	422
R22017	18-10	Clinton	21	79	153	113	87	315
R22018	18-16	Clinton	17	68	137	72	51	304
R22019	19-01	Clinton	23	48	151	67	50	354
R22020	19-02	Clinton	24	55	115	73	46	451
R22021	19-03	Clinton	24	56	104	89	44	389
R22022	19-04	Clinton	24	90	94	123	83	309
R22023	19-05	Clinton	22	99	104	133	96	274
R22024	19-13	Clinton	17	74	136	87	58	312
R22173	37-01	Coles	18	66	103	64	54	292
R22174	37-02	Coles	16	80	86	77	81	231
R22175	37-03	Coles	22	99	90	105	107	156

Continued on next page

Electronic Filing: Received, Clerk's Office 3/24/2022

Lab. no.	Sample ID	County	Pb	Rb	Sr	V	Zn	Zr
R22176	37-04	Coles	19	75	95	106	89	163
R22177	37-08	Coles	15	70	109	64	57	120
R22178	37-11	Coles	16	87	102	69	75	137
R22258	51-01	Coles	20	64	123	69	50	399
R22259	51-02	Coles	20	65	118	78	50	377
R22260	51-03	Coles	22	78	110	106	78	289
R22261	51-04	Coles	21	71	120	103	76	299
R22262	51-06	Coles	18	77	122	71	63	234
R22263	51-21	Coles	13	68	<50	51	51	149
R23540	128-1	Cook	146	80	145	74	209	188
R23541	128-2	Cook	43	93	117	86	96	261
R23542	128-3	Cook	11	54	172	<35	21	63
R23543	128-4	Cook	9	52	182	<35	20	64
R23544	128-7	Cook	12	60	165	<35	20	69
R23545	128-9	Cook	10	54	159	<35	20	62
R23750	130-1	Cook	39	113	148	97	114	244
R23751	130-3	Cook	22	87	168	99	122	270
R23752	130-5	Cook	22	94	168	94	122	278
R23753	130-8	Cook	22	102	188	109	102	283
R23754	130-12	Cook	19	94	173	91	90	182
R23755	130-13	Cook	21	98	156	93	91	182
R22156	35-01	Crawford	16	54	121	61	46	364
R22157	35-02	Crawford	19	66	115	79	52	354
R22158	35-03	Crawford	22	83	97	101	77	298
R22159	35-04	Crawford	22	77	104	105	80	294
R22160	35-06	Crawford	16	63	128	73	64	298
R22161	35-09	Crawford	15	59	106	70	52	264
R23528	126-1	DeKalb	24	100	144	90	100	352
R23529	126-2	DeKalb	21	92	154	103	108	354
R23530	126-3	DeKalb	22	84	150	117	98	348
R23531	126-5	DeKalb	21	80	162	128	97	363
R23532	126-7	DeKalb	20	80	190	110	87	400
R23533	126-11	DeKalb	10	71	131	51	39	175
R23774	134-1	DeKalb	23	87	130	84	101	428
R23775	134-2	DeKalb	20	81	141	103	71	413
R23776	134-3	DeKalb	20	78	141	112	73	404
R23777	134-4	DeKalb	20	77	142	107	71	417
R23778	134-5	DeKalb	17	80	134	88	66	307
R23779	134-6	DeKalb	12	70	112	51	44	146
R22264	52-1	Douglas	22	93	111	80	79	311
R22265	52-2	Douglas	ND	ND	121	ND	ND	303
R22266	52-3	Douglas	22	91	133	92	81	296
R22267	52-5	Douglas	19	78	134	90	74	310
R22268	52-7	Douglas	16	92	113	85	65	196
R22269	52-14	Douglas	16	83	123	58	58	152
R22365	66-01	Douglas	19	65	105	83	73	325
R22366	66-02	Douglas	21	84	94	100	79	250
R22367	66-03	Douglas	19	79	116	97	77	274
R22368	66-04	Douglas	19	73	128	88	74	288
R22369	66-05	Douglas	19	77	127	80	70	275
R22370	66-06	Douglas	16	77	113	62	61	186
R23744	129-1	DuPage	28	101	122	90	99	208
R23745	129-4	DuPage	23	97	129	83	87	181
R23746	129-5	DuPage	38	87	125	102	107	198
R23747	129-6	DuPage	21	88	170	107	93	305
R23748	129-7	DuPage	21	73	171	91	81	314
R23749	129-11	DuPage	20	98	113	74	94	148
R22204	67-01	Edgar	20	72	119	70	67	239
R22205	67-02	Edgar	30	70	117	77	73	360

Continued on next page

Electronic Filing: Received, Clerk's Office 3/24/2022

Lab. no.	Sample ID	County	Pb	Rb	Sr	V	Zn	Zr
R22206	67-03	Edgar	19	72	106	85	59	328
R22207	67-05	Edgar	22	82	96	114	91	268
R22208	67-07	Edgar	21	71	120	83	68	305
R22209	67-09	Edgar	15	69	131	50	58	151
R22037	22-01	Edwards	20	53	92	60	57	361
R22038	22-02	Edwards	18	51	78	58	46	350
R22039	22-03	Edwards	16	55	83	50	38	370
R22040	22-04	Edwards	15	46	69	49	35	324
R22041	22-08	Edwards	15	58	117	60	40	352
R22042	22-14	Edwards	16	59	78	58	53	155
R22049	24-01	Edwards	ND	ND	96	ND	ND	489
R22050	24-02	Edwards	19	73	97	80	55	426
R22051	24-03	Edwards	23	96	95	106	78	343
R22052	24-04	Edwards	25	97	97	109	83	338
R22053	24-10	Edwards	19	74	95	86	62	343
R22054	24-16	Edwards	16	68	76	78	48	362
R22185	39-1/2	Effingham	20	50	103	69	42	422
R22186	39-03	Effingham	22	89	93	101	76	306
R22187	39-04	Effingham	24	91	104	100	80	312
R22188	39-05	Effingham	23	82	126	89	69	340
R22189	39-07	Effingham	18	67	115	75	52	334
R22190	39-13	Effingham	15	41	103	75	45	207
R22116	30-01	Fayette	20	48	98	64	45	430
R22117	30-02	Fayette	18	61	102	79	45	400
R22118	30-03	Fayette	21	74	102	100	58	353
R22119	30-04	Fayette	20	72	109	100	65	309
R22120	30-08	Fayette	15	49	115	68	39	219
R22121	31-01	Fayette	18	60	108	72	57	334
R22122	31-02	Fayette	21	75	101	94	74	293
R22123	31-03	Fayette	20	64	106	81	67	248
R22124	31-04	Fayette	22	66	115	79	74	220
R22125	31-08	Fayette	17	58	124	62	56	237
R22126	31-20	Fayette	15	59	121	70	52	269
R22191	40-01	Fayette	30	47	119	69	150	376
R22192	40-02	Fayette	19	56	102	76	51	355
R22193	40-03	Fayette	19	73	123	89	63	341
R22194	40-04	Fayette	22	87	105	98	78	314
R22195	40-07	Fayette	25	87	141	100	90	319
R22196	40-14	Fayette	16	82	93	69	57	202
R22197	41-01	Fayette	23	51	141	75	46	542
R22198	41-02	Fayette	20	60	141	78	45	487
R22199	41-03	Fayette	20	60	113	89	49	380
R22200	41-04	Fayette	21	88	93	103	78	289
R22201	41-09	Fayette	15	59	110	64	43	297
R22202	41-23	Fayette	18	71	119	66	66	190
R23071	89-01	Ford	28	93	112	83	97	356
R23072	89-02	Ford	21	92	106	107	78	356
R23073	89-03	Ford	26	92	96	130	99	316
R23074	89-04	Ford	24	88	126	126	99	340
R23075	89-05	Ford	19	60	118	61	53	384
R23076	89-07	Ford	21	51	86	38	57	162
R22127	11-01	Franklin	19	61	125	69	50	426
R22128	11-02	Franklin	16	63	104	71	45	416
R22129	11-03	Franklin	16	61	97	69	41	399
R22130	11-05	Franklin	17	69	94	79	69	393
R22131	11-06	Franklin	12	52	100	64	36	391
R22132	11-34	Franklin	15	60	144	70	42	424
R23011	79-01	Fulton	27	84	123	73	64	123
R23012	79-02	Fulton	24	89	120	82	48	120

*Continued on next page*

Electronic Filing: Received, Clerk's Office 3/24/2022

Lab. no.	Sample ID	County	Pb	Rb	Sr	V	Zn	Zr
R23013	79-03	Fulton	24	99	114	112	74	114
R23014	79-04	Fulton	23	97	107	126	99	107
R23015	79-06	Fulton	24	87	117	113	98	117
R23016	79-11	Fulton	19	72	143	81	63	143
R23041	84-01	Fulton	20	86	126	92	60	427
R23042	84-02	Fulton	22	88	123	116	77	376
R23043	84-03	Fulton	21	82	124	112	76	361
R23044	84-05	Fulton	19	80	134	101	66	403
R23045	84-09	Fulton	11	50	82	48	36	116
R23046	84-14	Fulton	13	57	94	53	42	183
R23047	85-01	Fulton	27	92	135	89	88	465
R23048	85-02	Fulton	24	90	125	109	81	405
R23049	85-03	Fulton	26	86	127	116	90	400
R23050	85-05	Fulton	20	82	136	113	94	389
R23051	85-09	Fulton	20	84	146	93	70	457
R23052	85-13	Fulton	18	74	137	74	56	376
R22228	46-01	Greene	20	76	132	66	67	357
R22229	46-02	Greene	18	79	143	68	64	352
R22230	46-04	Greene	18	90	142	79	70	359
R22231	46-05	Greene	19	93	141	88	84	338
R22232	46-08	Greene	21	74	143	96	83	316
R22233	46-33	Greene	20	84	107	66	66	194
R23190	103-1	Grundy	21	89	134	88	77	277
R23191	103-2	Grundy	18	88	137	96	70	282
R23192	103-3	Grundy	18	78	149	100	74	317
R23193	103-4	Grundy	10	50	108	68	42	258
R23194	103-5	Grundy	20	70	147	99	71	312
R22133	12-02	Hamilton	21	100	135	94	80	333
R22134	12-03	Hamilton	21	107	133	106	86	298
R22135	12-04	Hamilton	21	107	122	102	88	294
R22136	12-06	Hamilton	22	109	126	108	90	294
R22137	12-19	Hamilton	19	91	147	86	68	400
R22203	12-27	Hamilton	21	113	111	107	102	197
R23023	81-01	Hancock	29	74	126	88	63	462
R23024	81-02	Hancock	20	77	130	98	51	468
R23025	81-03	Hancock	26	86	132	126	69	381
R23026	81-05	Hancock	20	78	100	111	58	354
R23027	81-07	Hancock	22	87	97	112	64	333
R23028	81-13	Hancock	23	82	94	108	89	283
R23029	82-01	Hancock	147	88	131	87	110	446
R23030	82-02	Hancock	21	90	129	111	80	384
R23031	82-03	Hancock	29	91	132	94	72	458
R23032	82-04	Hancock	23	87	142	121	93	357
R23033	82-09	Hancock	21	82	174	117	94	360
R23034	82-13	Hancock	17	72	166	90	60	440
R23344	107-1	Henry	22	83	128	106	76	392
R23345	107-2	Henry	21	81	154	104	71	470
R23346	107-3	Henry	20	78	173	99	62	520
R23347	107-4	Henry	19	80	185	94	59	487
R23348	107-6	Henry	18	86	175	94	47	427
R23349	107-9	Henry	23	100	115	103	72	277
R23350	108-1	Henry	24	122	136	97	92	362
R23351	108-2	Henry	23	113	148	110	84	369
R23352	108-3	Henry	23	100	141	119	84	357
R23353	108-5	Henry	22	84	163	121	94	383
R23354	108-7	Henry	20	72	183	103	79	463
R23355	108-10	Henry	17	69	172	76	60	416
R23390	110-1	Henry	17	62	163	61	34	337
R23391	110-2	Henry	14	67	145	87	47	261

Continued on next page

Electronic Filing: Received, Clerk's Office 3/24/2022

Lab. no.	Sample ID	County	Pb	Rb	Sr	V	Zn	Zr
R23392	110-3	Henry	16	66	155	88	48	233
R23393	110-5	Henry	11	59	184	69	38	135
R23394	110-7	Henry	8	44	157	38	19	108
R23395	110-9	Henry	6	38	167	<35	13	108
R23396	111-1	Henry	17	61	151	71	52	245
R23397	111-2	Henry	13	60	143	72	48	238
R23398	111-3	Henry	13	58	154	69	43	260
R23399	111-4	Henry	13	60	164	69	47	279
R23400	111-5	Henry	11	56	143	56	37	210
R23401	111-6	Henry	7	37	103	<35	13	66
R23135	97-01	Iroquois	23	113	140	94	82	309
R23136	97-02	Iroquois	21	113	150	93	79	324
R23137	97-03	Iroquois	20	116	153	104	77	316
R23138	97-05	Iroquois	18	111	160	94	76	330
R23139	97-07	Iroquois	24	130	126	112	92	261
R23140	97-09	Iroquois	22	123	125	102	94	241
R23147	99-01	Iroquois	12	48	122	<35	28	187
R23148	99-02	Iroquois	9	47	126	38	16	242
R23149	99-03	Iroquois	10	47	134	<35	11	258
R23150	99-06	Iroquois	9	51	143	41	19	220
R23152	99-08	Iroquois	8	46	145	<35	12	174
R23153	99-09	Iroquois	8	47	167	<35	12	167
R23153	100-01	Iroquois	47	96	129	77	128	313
R23154	100-02	Iroquois	28	113	113	98	110	244
R23155	100-03	Iroquois	29	117	112	99	127	253
R23156	100-05	Iroquois	27	100	106	77	114	195
R23157	100-06	Iroquois	24	94	105	68	112	157
R23158	100-08	Iroquois	23	100	104	67	108	174
R23159	101-01	Iroquois	33	129	128	112	82	310
R23160	101-02	Iroquois	26	148	138	138	88	249
R23161	101-03	Iroquois	27	150	140	142	96	224
R23162	101-04	Iroquois	24	177	130	136	96	176
R23163	101-05	Iroquois	24	168	128	128	91	174
R23164	101-07	Iroquois	22	179	125	122	92	152
R21838	8-01	Jackson	38	67	179	70	110	255
R21839	8-02	Jackson	28	68	131	60	69	408
R21840	8-03	Jackson	18	68	119	64	23	405
R21841	8-06	Jackson	16	68	144	53	20	401
R21893	8-12	Jackson	25	59	152	91	64	333
R21894	8-22	Jackson	19	77	201	100	68	393
R22179	38-01	Jasper	20	58	105	63	47	233
R22180	38-02	Jasper	19	65	105	72	46	239
R22181	38-03	Jasper	19	65	122	72	46	386
R22182	38-05	Jasper	24	92	102	120	91	249
R22183	38-08	Jasper	18	74	115	72	48	249
R22184	38-13	Jasper	18	94	105	70	65	190
R22061	26-01	Jefferson	25	49	107	58	43	437
R22062	26-02	Jefferson	16	54	97	62	40	455
R22063	26-03	Jefferson	19	59	98	73	45	439
R22064	26-04	Jefferson	18	54	88	72	38	412
R22065	26-08	Jefferson	19	102	105	102	79	278
R22066	26-15	Jefferson	20	191	141	149	139	188
R22216	44-01	Jersey	20	58	136	61	44	423
R22217	44-02	Jersey	19	62	125	78	52	357
R22218	44-03	Jersey	21	87	115	99	94	306
R22219	44-04	Jersey	19	73	116	94	83	299
R22220	44-13	Jersey	18	67	125	77	49	319
R22221	44-29	Jersey	15	62	113	52	58	140

Continued on next page



Electronic Filing: Received, Clerk's Office 3/24/2022

Lab. no.	Sample ID	County	Pb	Rb	Sr	V	Zn	Zr
R23461	119-1	Jo Daviess	32	71	163	70	69	562
R23462	119-2	Jo Daviess	26	76	173	78	51	510
R23463	119-3	Jo Daviess	24	80	164	96	58	500
R23464	119-5	Jo Daviess	19	77	165	102	66	496
R23465	119-6	Jo Daviess	19	83	175	92	62	414
R23466	119-11	Jo Daviess	<5	176	117	101	61	101
R23467	120-1	Jo Daviess	23	98	142	92	79	390
R23468	120-2	Jo Daviess	20	94	138	101	73	400
R23469	120-4	Jo Daviess	19	79	153	114	77	370
R23470	120-5	Jo Daviess	20	80	163	119	78	362
R23471	120-8	Jo Daviess	20	88	175	94	60	395
R23472	120-15	Jo Daviess	17	107	144	106	52	368
R21766	3-01	Johnson	23	64	112	64	19	586
R21767	3-02	Johnson	19	72	119	73	20	540
R21768	3-03	Johnson	20	72	114	76	23	523
R21769	3-04	Johnson	20	79	105	86	34	462
R21770	3-05	Johnson	20	85	107	96	49	344
R21771	3-10	Johnson	17	90	148	76	41	337
R21772	3-14	Johnson	13	122	124	133	60	81
R23768	133-1	Kane	20	84	143	68	51	410
R23769	133-2	Kane	19	84	133	86	58	370
R23770	133-3	Kane	17	82	135	79	56	337
R23771	133-4	Kane	17	79	146	69	52	341
R23772	133-5	Kane	13	62	131	48	38	245
R23773	133-6	Kane	11	54	130	40	32	225
R23790	135-1	Kane	24	89	126	91	77	402
R23791	135-2	Kane	22	94	112	109	89	262
R23792	135-3	Kane	26	99	113	107	101	189
R23793	135-4	Kane	31	122	98	120	138	192
R23794	135-5	Kane	27	98	95	89	103	138
R23795	135-6	Kane	19	73	87	62	86	111
R23141	98-01	Kankakee	40	84	120	72	116	286
R23142	98-02	Kankakee	47	78	94	82	162	197
R23143	98-03	Kankakee	43	73	109	66	126	228
R23144	98-05	Kankakee	30	72	94	77	101	218
R23145	98-06	Kankakee	107	69	75	66	152	131
R23146	98-07	Kankakee	13	51	64	<35	41	71
R23165	102-1	Kankakee	20	71	113	62	57	330
R23166	102-2	Kankakee	13	64	133	57	40	379
R23167	102-3	Kankakee	16	66	133	70	53	332
R23168	102-4	Kankakee	19	71	122	94	77	302
R23169	102-5	Kankakee	19	84	114	98	94	256
R23170	102-6	Kankakee	11	52	110	40	42	186
R23796	136-1	Kendall	34	93	135	79	100	388
R23797	136-4	Kendall	22	81	122	113	73	377
R23798	136-6	Kendall	22	79	143	107	74	382
R23799	136-8	Kendall	17	71	126	76	62	253
R23800	136-9	Kendall	15	64	104	57	63	173
R23801	136-10	Kendall	14	62	107	56	62	164
R23083	91-01	Knox	24	92	122	88	78	421
R23084	91-02	Knox	22	92	122	92	76	430
R23085	91-03	Knox	21	94	121	111	77	457
R23086	91-05	Knox	23	89	118	124	87	398
R23087	91-07	Knox	22	80	146	106	74	456
R23088	91-11	Knox	18	78	143	88	60	439
R23756	131-1	Lake	23	106	125	90	81	188
R23757	131-3	Lake	24	139	102	122	82	204
R23758	131-4	Lake	20	109	98	94	60	151
R23759	131-5	Lake	16	108	119	87	59	127

Continued on next page



Electronic Filing: Received, Clerk's Office 3/24/2022

Lab. no.	Sample ID	County	Pb	Rb	Sr	V	Zn	Zr
R23760	131-6	Lake	17	110	119	91	61	127
R23761	131-7	Lake	16	109	128	87	59	136
R23195	104-1	LaSalle	23	90	135	83	84	368
R23196	104-2	LaSalle	22	92	128	92	68	358
R23197	104-3	LaSalle	22	90	129	117	80	331
R23198	104-4	LaSalle	21	83	139	119	80	343
R23199	104-6	LaSalle	20	71	150	90	67	326
R23200	104-8	LaSalle	18	79	149	76	66	221
R23414	114-1	LaSalle	46	99	142	86	161	381
R23415	114-2	LaSalle	23	76	126	90	90	386
R23416	114-3	LaSalle	21	81	145	117	88	381
R23417	114-4	LaSalle	22	78	156	112	83	386
R23418	114-5	LaSalle	21	74	157	101	74	369
R23419	114-6	LaSalle	19	68	141	81	64	334
R22150	34-01	Lawrence	19	61	105	62	48	401
R22151	34-02	Lawrence	17	61	98	61	45	408
R22152	34-03	Lawrence	16	64	99	74	48	389
R22153	34-04	Lawrence	19	83	97	92	67	353
R22154	34-10	Lawrence	17	61	114	66	51	282
R22155	34-13	Lawrence	15	55	71	64	42	265
R23437	115-1	Lee	33	71	165	83	110	356
R23438	115-2	Lee	20	71	181	84	68	398
R23439	115-3	Lee	18	66	165	88	71	358
R23440	115-5	Lee	18	68	162	88	72	280
R23441	115-7	Lee	14	67	178	76	53	330
R23442	115-9	Lee	14	57	159	56	47	318
R23443	116-1	Lee	18	58	113	56	47	310
R23444	116-3	Lee	13	59	104	68	42	303
R23445	116-4	Lee	14	57	114	73	40	257
R23446	116-5	Lee	11	44	95	56	30	190
R23447	116-6	Lee	8	34	86	41	18	115
R23448	116-9	Lee	<5	23	77	<35	11	58
R23123	95-01	Livingston	29	94	67	84	80	239
R23124	95-02	Livingston	21	99	110	91	72	321
R23125	95-03	Livingston	24	98	94	119	88	292
R23126	95-05	Livingston	22	90	114	120	82	313
R23127	95-08	Livingston	22	92	106	81	72	240
R23128	95-13	Livingston	24	151	70	107	93	141
R23129	96-01	Livingston	36	126	101	117	118	257
R23130	96-02	Livingston	40	124	76	123	198	199
R23131	96-03	Livingston	43	104	58	81	184	117
R23132	96-04	Livingston	34	119	62	94	182	142
R23133	96-07	Livingston	24	147	79	104	108	141
R23134	96-11	Livingston	29	154	79	103	109	132
R22347	64-01	Logan	22	68	128	73	67	385
R22348	64-02	Logan	19	72	126	77	71	388
R22349	64-03	Logan	21	73	102	87	78	379
R22350	64-06	Logan	18	63	148	74	68	412
R22351	64-08	Logan	19	54	66	55	58	320
R22352	64-22	Logan	22	99	94	90	85	252
R22686	74-01	Logan	16	66	113	71	59	295
R22687	74-03	Logan	15	58	116	78	53	295
R22688	74-04	Logan	16	65	118	80	61	309
R22689	74-05	Logan	13	45	115	84	46	276
R22690	74-07	Logan	15	64	117	75	58	297
R22691	74-11	Logan	11	38	117	40	37	285
R22704	77-1	Logan	13	38	112	44	12	301
R22705	77-2	Logan	16	43	102	47	12	281
R22706	77-5	Logan	19	57	107	45	14	286

Continued on next page

Electronic Filing: Received, Clerk's Office 3/24/2022

Lab. no.	Sample ID	County	Pb	Rb	Sr	V	Zn	Zr
R22707	77-8	Logan	19	52	137	44	12	347
R22708	77-14	Logan	12	25	108	<35	8	113
R22709	77-26	Logan	21	41	169	50	13	357
R22692	75-01	Macon	16	49	106	71	42	338
R22693	75-02	Macon	15	62	100	89	59	281
R22694	75-03	Macon	16	62	102	100	70	260
R22695	75-04	Macon	16	58	112	92	65	289
R22696	75-06	Macon	15	51	115	73	52	278
R22697	75-10	Macon	11	58	98	50	46	133
R22210	43-01	Macoupin	18	53	109	57	43	411
R22211	43-03	Macoupin	18	50	118	84	50	328
R22212	43-05	Macoupin	21	68	105	102	83	287
R22213	43-08	Macoupin	18	61	179	78	69	388
R22214	43-12	Macoupin	18	73	126	77	58	300
R22215	43-27	Macoupin	15	58	102	47	51	136
R22234	47-01	Macoupin	16	60	124	57	49	386
R22235	47-02	Macoupin	16	64	124	62	52	393
R22236	47-04	Macoupin	15	58	133	55	45	324
R22237	47-05	Macoupin	16	66	105	60	50	361
R22238	47-08	Macoupin	15	61	115	62	53	317
R22239	47-16	Macoupin	20	76	129	74	65	300
R22104	28-01	Madison	19	55	129	59	56	396
R22105	28-02	Madison	17	62	109	87	77	281
R22106	28-03	Madison	16	72	131	74	57	366
R22107	28-04	Madison	18	78	122	78	62	328
R22108	28-10	Madison	17	57	129	65	44	416
R22209	28-15	Madison	16	64	138	67	55	369
R22025	20-01	Marion	22	52	100	77	52	408
R22026	20-02	Marion	19	61	106	85	43	405
R22027	20-03	Marion	24	91	123	118	78	434
R22028	20-04	Marion	24	102	104	128	102	274
R22029	20-08	Marion	17	72	106	83	59	328
R22030	20-11	Marion	18	68	96	79	44	328
R22710	78-01	Mason	11	24	77	<35	7	134
R22711	78-03	Mason	17	51	88	50	13	238
R22712	78-04	Mason	16	39	75	37	11	140
R22713	78-09	Mason	12	22	88	<35	6	59
R22714	78-12	Mason	14	24	99	<35	8	89
R22715	78-17	Mason	11	20	88	<35	5	53
R23017	80-01	McDonough	22	57	121	59	49	319
R23018	80-04	McDonough	19	68	120	73	52	363
R23019	80-08	McDonough	20	63	120	69	48	310
R23020	80-10	McDonough	18	73	119	79	51	361
R23021	80-15	McDonough	18	81	137	83	63	367
R23022	80-20	McDonough	19	83	157	91	74	374
R23035	83-01	McDonough	21	103	118	94	80	389
R23036	83-02	McDonough	20	102	119	109	82	387
R23037	83-04	McDonough	24	90	127	127	90	358
R23038	83-05	McDonough	21	86	139	114	81	371
R23039	83-10	McDonough	19	80	148	97	77	438
R23040	83-14	McDonough	18	59	108	90	31	404
R23762	132-1	McHenry	24	82	131	89	90	383
R23763	132-2	McHenry	18	70	134	98	62	307
R23764	132-3	McHenry	21	74	123	112	71	378
R23765	132-4	McHenry	17	77	125	78	58	202
R23766	132-5	McHenry	11	58	113	49	38	152
R23767	132-6	McHenry	12	51	127	47	34	229
R22674	72-01	McLean	17	68	107	72	64	287
R22675	72-02	McLean	16	73	100	84	68	262

Continued on next page

Electronic Filing: Received, Clerk's Office 3/24/2022

Lab. no.	Sample ID	County	Pb	Rb	Sr	V	Zn	Zr
R22676	72-03	McLean	17	71	109	95	77	273
R22677	72-04	McLean	16	64	109	91	72	273
R22678	72-06	McLean	15	63	119	81	62	284
R22679	72-09	McLean	12	64	90	59	48	168
R22680	73-01	McLean	16	52	100	70	48	309
R22681	73-02	McLean	15	62	99	84	59	280
R22682	73-03	McLean	16	60	99	90	66	262
R22683	73-04	McLean	15	53	108	85	58	287
R22684	73-05	McLean	15	52	118	80	58	200
R22685	73-06	McLean	13	46	116	67	52	312
R23065	88-01	McLean	50	88	92	90	99	349
R23066	88-02	McLean	23	92	93	102	77	372
R23067	88-03	McLean	23	88	95	119	92	340
R23068	88-05	McLean	26	89	100	110	91	350
R23069	88-07	McLean	53	88	66	102	187	161
R23070	88-08	McLean	54	60	75	50	108	100
R22270	53-01	Menard	21	73	110	90	82	305
R22271	53-02	Menard	22	83	98	85	73	268
R22272	53-03	Menard	18	61	97	63	46	235
R22273	53-04	Menard	23	76	106	103	84	253
R22274	53-05	Menard	19	67	102	85	79	251
R22275	53-11	Menard	13	70	97	54	55	133
R22342	63-01	Menard	16	60	136	60	57	406
R22343	63-02	Menard	16	58	142	56	53	458
R22344	63-03	Menard	16	61	154	59	53	483
R22345	63-06	Menard	15	64	164	61	53	450
R22346	63-15	Menard	15	57	153	59	54	372
R23384	109-1	Mercer	19	82	141	88	64	478
R23385	109-3	Mercer	28	86	166	77	112	517
R23386	109-4	Mercer	29	86	166	80	102	542
R23387	109-5	Mercer	21	80	152	92	67	446
R23388	109-7	Mercer	20	76	156	86	64	370
R23389	109-9	Mercer	17	71	159	74	63	261
R22002	16-01	Monroe	24	83	113	106	74	359
R22003	16-02	Monroe	24	82	115	126	87	297
R22004	16-03	Monroe	19	62	150	172	81	254
R22005	16-04	Monroe	16	61	173	119	78	317
R22006	16-16	Monroe	16	77	126	89	58	281
R22007	16-26	Monroe	18	66	136	66	64	209
R22008	17-01	Monroe	72	93	169	110	138	217
R22009	17-02	Monroe	60	100	160	113	139	197
R22010	17-03	Monroe	38	97	165	118	111	188
R22011	17-04	Monroe	22	95	174	121	91	213
R22012	17-16	Monroe	18	73	255	78	63	323
R22204	42-01	Montgomery	16	53	106	52	53	270
R22205	42-02	Montgomery	15	56	96	57	49	278
R22206	42-04	Montgomery	ND	ND	94	ND	ND	240
R22207	42-06	Montgomery	14	46	86	54	44	180
R22208	42-16	Montgomery	13	43	86	38	46	121
R22209	42-23	Montgomery	20	89	119	81	84	306
R22240	48-01	Montgomery	20	67	131	67	57	382
R22241	48-03	Montgomery	19	81	122	85	71	328
R22242	48-04	Montgomery	24	91	112	102	92	298
R22243	48-06	Montgomery	22	79	122	102	86	300
R22244	48-09	Montgomery	21	77	152	88	78	342
R22245	48-16	Montgomery	19	81	96	65	61	201
R22294	57-01	Morgan	22	57	112	63	57	378
R22295	57-02	Morgan	19	82	116	88	76	318
R22296	57-03	Morgan	22	83	95	94	89	268

Continued on next page

Electronic Filing: Received, Clerk's Office 3/24/2022

Lab. no.	Sample ID	County	Pb	Rb	Sr	V	Zn	Zr
R22297	57-05	Morgan	21	73	113	88	84	288
R22298	57-11	Morgan	15	62	183	73	50	421
R22299	57-16	Morgan	14	62	194	72	50	441
R23504	122-1*	Ogle	308	88	147	82	348	303
R23505	122-2*	Ogle	110	98	148	99	519	389
R23506	122-3*	Ogle	26	101	154	99	83	400
R23507	122-5	Ogle	21	79	166	107	99	423
R23508	122-8	Ogle	18	72	196	99	73	429
R23509	122-9	Ogle	16	68	160	73	48	346
R23510	123-1	Ogle	26	81	143	82	93	463
R23511	123-2	Ogle	21	79	144	107	70	422
R23512	123-3	Ogle	19	63	135	99	60	415
R23513	123-4	Ogle	20	70	155	108	30	402
R23514	123-7	Ogle	22	99	136	104	76	281
R23515	123-8	Ogle	21	107	118	91	91	263
R23089	92-01	Peoria	69	92	112	101	138	449
R23090	92-02	Peoria	29	93	105	114	89	395
R23091	92-03	Peoria	24	89	104	117	88	407
R23092	92-04	Peoria	22	82	124	112	82	435
R23093	92-06	Peoria	20	82	136	98	63	477
R23094	92-09	Peoria	17	78	140	85	57	382
R23095	93-01	Peoria	27	87	124	81	69	495
R23096	93-02	Peoria	20	97	115	99	76	451
R23097	93-03	Peoria	24	96	107	106	91	410
R23098	93-04	Peoria	23	89	105	108	97	419
R23099	93-06	Peoria	22	83	125	94	86	482
R23100	93-09	Peoria	14	93	106	68	56	159
R21895	9-01	Perry	57	68	122	79	80	403
R21896	9-02	Perry	24	70	125	81	45	413
R21897	9-03	Perry	22	76	114	94	52	398
R21898	9-07	Perry	23	82	132	119	82	303
R21899	9-12	Perry	17	62	182	85	56	373
R21900	9-20	Perry	24	66	85	92	79	256
R21901	10-01	Perry	22	78	151	103	62	369
R21902	10-02	Perry	19	81	163	99	62	344
R21903	10-03	Perry	17	81	145	92	57	357
R21904	10-05	Perry	17	75	116	90	53	318
R21905	10-10	Perry	21	92	114	98	62	294
R21906	10-16	Perry	18	72	105	80	59	307
R22222	45-01	Pike	18	59	144	62	45	478
R22223	45-02	Pike	18	72	144	82	57	423
R22224	45-03	Pike	22	76	124	100	79	325
R22225	45-05	Pike	23	76	134	99	82	326
R22226	45-09	Pike	16	67	193	79	57	386
R22227	45-17	Pike	28	84	85	108	100	395
R22300	58-01	Pike	18	58	130	61	44	449
R22301	58-02	Pike	19	76	139	67	53	406
R22302	58-03	Pike	22	98	116	114	96	316
R22303	58-04	Pike	23	92	116	96	98	328
R22304	58-07	Pike	21	75	128	83	85	331
R22305	58-10	Pike	18	51	128	59	61	325
R22306	58-31	Pike	15	60	202	76	51	446
R22307	59-01	Pike	20	79	153	87	69	419
R22308	59-02	Pike	21	82	143	101	85	358
R22309	59-03	Pike	21	77	161	103	81	355
R22310	59-06	Pike	19	71	173	96	79	367
R22311	59-13	Pike	16	68	174	80	56	402
R22312	59-16	Pike	15	60	119	74	52	378
R21832	4-01	Pope	38	138	96	117	138	196

Continued on next page

Electronic Filing: Received, Clerk's Office 3/24/2022

Lab. no.	Sample ID	County	Pb	Rb	Sr	V	Zn	Zr
R21833	4-02	Pope	28	149	104	121	113	189
R21834	4-03	Pope	27	152	95	127	101	193
R21835	4-04	Pope	27	151	93	121	103	186
R21836	4-08	Pope	26	148	96	125	101	187
R21837	4-12	Pope	25	147	102	128	96	191
R21773	5-01	Pope	26	76	93	63	40	448
R21774	5-02	Pope	24	78	82	67	37	456
R21775	5-03	Pope	21	85	89	78	44	419
R21776	5-04	Pope	22	87	77	89	49	323
R21777	5-07	Pope	20	75	123	73	40	378
R21778	5-14	Pope	15	61	97	67	21	460
R21826	1-01	Pulaski	30	114	133	104	96	212
R21827	1-02	Pulaski	23	116	125	112	87	207
R21828	1-03	Pulaski	22	119	120	113	80	191
R21829	1-04	Pulaski	22	120	123	114	84	192
R21830	1-08	Pulaski	23	130	133	128	89	161
R21831	1-11	Pulaski	20	114	125	126	86	171
R23201	105-1	Putnam	31	92	137	92	96	419
R23202	105-2	Putnam	22	90	134	108	77	380
R23203	105-3	Putnam	20	82	137	116	78	348
R23204	105-5	Putnam	21	77	158	99	69	409
R23205	105-7	Putnam	20	120	107	92	76	146
R23206	105-12	Putnam	19	122	100	84	78	126
R22144	33-01	Richland	21	61	93	78	60	310
R22145	33-02	Richland	22	70	99	84	62	342
R22146	33-03	Richland	18	67	147	78	45	385
R22147	33-04	Richland	20	74	102	88	47	371
R22148	33-06	Richland	18	78	109	95	59	283
R22149	33-10	Richland	18	106	107	99	61	224
R21779	6-01	Saline	32	87	111	82	36	307
R21780	6-02	Saline	21	123	100	115	55	213
R21781	6-03	Saline	22	132	101	128	71	170
R21782	6-04	Saline	21	130	115	119	79	190
R21783	6-06	Saline	23	134	127	123	104	174
R21784	6-20	Saline	18	131	170	101	58	84
R22282	55-01	Sangamon	20	78	115	74	75	287
R22283	55-03	Sangamon	15	69	137	65	63	342
R22284	55-06	Sangamon	15	69	126	59	60	339
R22285	55-08	Sangamon	14	66	126	59	56	330
R22286	55-11	Sangamon	14	65	127	61	57	302
R22287	55-28	Sangamon	ND	ND	93	ND	ND	106
R22288	56-01	Sangamon	27	77	111	74	88	323
R22289	56-02	Sangamon	15	81	102	73	64	314
R22290	56-03	Sangamon	15	60	102	82	56	306
R22291	56-05	Sangamon	15	47	96	96	62	235
R22292	56-07	Sangamon	14	47	113	84	57	305
R22293	56-11	Sangamon	15	57	173	71	62	338
R22252	50-01	Shelby	21	64	102	83	53	326
R22253	50-02	Shelby	21	76	93	92	75	297
R22254	50-03	Shelby	21	76	102	98	78	307
R22255	50-05	Shelby	18	89	123	79	67	226
R22256	50-07	Shelby	16	79	141	57	61	150
R22257	50-16	Shelby	13	79	122	59	56	141
R22098	27-1	St. Clair	19	55	138	62	48	478
R22099	27-2	St. Clair	17	62	129	71	48	416
R22100	27-3	St. Clair	16	72	129	87	61	377
R22101	27-4	St. Clair	18	78	120	106	84	324
R22102	27-9	St. Clair	17	57	176	86	65	380
R22103	27-13	St. Clair	16	64	179	78	57	381

Continued on next page

## Electronic Filing: Received, Clerk's Office 3/24/2022

Lab. no.	Sample ID	County	Pb	Rb	Sr	V	Zn	Zr
R23498	121-1	Stephenson	22	70	136	76	94	509
R23499	121-2	Stephenson	19	74	149	74	54	569
R23500	121-3	Stephenson	19	82	138	86	60	488
R23501	121-5	Stephenson	20	90	144	88	70	451
R23502	121-8	Stephenson	21	82	139	104	72	427
R23503	121-10	Stephenson	19	76	163	106	73	438
R23053	86-01	Tazewell	43	87	135	77	74	452
R23054	86-02	Tazewell	31	96	115	107	63	423
R23055	86-03	Tazewell	24	96	105	131	97	363
R23056	86-05	Tazewell	22	89	116	112	99	387
R23057	86-07	Tazewell	23	90	146	106	104	399
R23058	86-12	Tazewell	18	74	147	82	59	404
R21759	2-01	Union	21	80	100	71	43	469
R21760	2-02	Union	22	92	102	92	52	346
R21761	2-03	Union	23	92	104	98	55	328
R21762	2-04	Union	21	89	114	94	53	352
R21763	2-06	Union	22	89	127	95	58	358
R21764	2-13	Union	17	78	179	73	33	384
R21765	2-26	Union	16	64	67	66	24	435
R22377	68-01	Vermilion	20	65	117	74	61	393
R22378	68-02	Vermilion	22	90	104	108	86	307
R22379	68-03	Vermilion	24	73	105	108	85	294
R22380	68-04	Vermilion	19	74	105	99	81	271
R22381	68-06	Vermilion	19	64	140	56	69	226
R22382	68-09	Vermilion	19	79	108	55	66	167
R22506	69-01	Vermilion	28	136	92	88	108	185
R22507	69-03	Vermilion	22	114	104	85	113	209
R22508	69-04	Vermilion	22	110	110	86	115	210
R22509	69-05	Vermilion	18	83	119	74	90	217
R22510	69-08	Vermilion	18	92	90	70	80	159
R22511	69-11	Vermilion	19	98	89	67	77	158
R22043	23-01	Wabash	19	55	121	70	55	456
R22044	23-02	Wabash	21	58	95	69	57	294
R22045	23-03	Wabash	18	70	115	83	60	393
R22046	23-04	Wabash	23	95	106	109	91	317
R22047	23-08	Wabash	20	76	135	91	80	338
R22048	23-14	Wabash	20	78	96	92	58	373
R23077	90-01	Warren	44	90	130	86	101	456
R23078	90-02	Warren	21	91	142	103	78	458
R23079	90-03	Warren	20	82	136	111	77	417
R23080	90-05	Warren	21	79	156	114	66	399
R23081	90-07	Warren	20	77	177	109	89	422
R23082	90-11	Warren	17	70	168	90	63	401
R21990	14-01	Washington	23	54	105	73	51	459
R21991	14-02	Washington	21	54	116	78	51	463
R21992	14-03	Washington	21	61	109	87	50	435
R21993	14-04	Washington	20	81	116	108	72	368
R21994	14-06	Washington	23	80	155	113	86	348
R21995	14-15	Washington	17	74	127	87	59	351
R21996	15-01	Washington	19	60	115	71	45	411
R21997	15-02	Washington	20	56	106	87	40	396
R21998	15-03	Washington	27	96	84	136	93	290
R21999	15-04	Washington	29	112	74	152	116	242
R22000	15-13	Washington	19	93	125	92	68	348
R22001	15-20	Washington	19	83	96	99	81	289
R22031	21-01	Wayne	25	72	94	81	57	358
R22032	21-02	Wayne	20	69	96	80	46	366
R22033	21-03	Wayne	18	71	97	82	43	380
R22034	21-04	Wayne	24	107	95	118	83	285

*Continued on next page*



Electronic Filing: Received, Clerk's Office 3/24/2022

Lab. no.	Sample ID	County	Pb	Rb	Sr	V	Zn	Zr
R22035	21-07	Wayne	18	89	136	99	64	340
R22036	21-10	Wayne	21	108	116	105	65	308
R22055	25-01	Wayne	18	71	115	87	50	365
R22056	25-02	Wayne	ND	ND	116	ND	ND	366
R22057	25-03	Wayne	19	84	117	93	57	361
R22058	25-04	Wayne	20	97	114	97	71	334
R22059	25-22	Wayne	18	96	141	116	79	254
R22060	25-29	Wayne	19	122	130	127	105	223
R21985	13-01	White	32	41	142	45	71	266
R21986	13-02	White	14	55	139	55	42	278
R21987	13-03	White	15	69	138	73	51	247
R21988	13-04	White	16	66	146	76	55	254
R21989	13-18	White	11	37	158	37	41	99
R23449	117-1	Whiteside	20	74	166	70	69	350
R23450	117-2	Whiteside	16	62	179	62	52	406
R23451	117-3	Whiteside	16	58	184	49	44	460
R23452	117-5	Whiteside	11	56	189	48	37	462
R23453	117-6	Whiteside	11	52	190	50	33	390
R23454	117-8	Whiteside	10	52	201	48	30	402
R23534	127-1	Will	39	119	121	104	97	264
R23535	127-3	Will	22	131	112	121	84	215
R223536	127-4	Will	20	124	125	109	77	170
R23537	127-5	Will	18	120	122	101	72	148
R23538	127-6	Will	18	127	132	102	78	158
R23539	127-7	Will	19	130	123	99	80	158
R23802	137-1	Will	31	99	129	90	82	369
R23803	137-2	Will	22	87	131	117	74	374
R23804	137-3	Will	27	87	123	117	81	369
R23805	137-4	Will	36	118	105	126	139	219
R23806	137-5	Will	37	126	104	124	160	199
R23807	137-6	Will	22	112	117	98	88	189
R21785	7-01	Williamson	24	74	93	64	39	442
R21786	7-02	Williamson	22	87	95	92	40	352
R21787	7-03	Williamson	20	86	93	94	44	341
R21788	7-06	Williamson	22	82	127	90	52	324
R21789	7-21	Williamson	15	75	106	69	19	313
R23516	124-1	Winnebago	16	61	113	54	46	207
R23517	124-2	Winnebago	12	66	113	56	41	180
R23518	124-3	Winnebago	11	56	115	39	31	141
R23519	124-4	Winnebago	8	51	112	<35	26	120
R23520	124-5	Winnebago	9	50	120	<35	26	120
R23521	124-7	Winnebago	8	50	120	<35	24	103
R23059	87-01	Woodford	33	86	125	91	62	498
R23060	87-02	Woodford	28	83	116	81	56	490
R23061	87-03	Woodford	27	83	126	86	60	505
R23062	87-04	Woodford	23	91	124	116	101	362
R23063	87-05	Woodford	22	82	138	100	93	444
R23064	87-06	Woodford	19	72	137	87	76	374
R23117	94-01	Woodford	25	104	112	92	92	325
R23118	94-02	Woodford	22	104	102	102	83	352
R23119	94-04	Woodford	22	91	113	119	91	366
R23120	94-06	Woodford	23	87	132	110	90	368
R23121	94-08	Woodford	18	67	98	80	67	285
R23122	94-12	Woodford	12	44	56	<35	51	72



**APPENDIX 6—LABORATORY NUMBER, SITE IDENTIFICATION, COUNTY, DEPTH  
INTERVAL, LOCATION, LAND COVER, LAND USE, AND ELEMENTAL CONCENTRATIONS  
(SMITH ET AL. 2013)**

Note: ND, not determined.

Lab no.	Site ID	County	Depth interval (cm)	Latitude	Longitude	Land cover	Land use
C-348582	9896	Adams	0–5	39.9549	–90.9204	Planted/cultivated	Row crops
C-348589	9896	Adams	0–20	39.9549	–90.9204	Planted/cultivated	Row crops
C-348596	9896	Adams	130–155	39.9549	–90.9204	Planted/cultivated	Row crops
C-348613	12200	Adams	0–5	40.0222	–91.2606	Planted/cultivated	Row crops
C-348640	12200	Adams	0–20	40.0222	–91.2606	Planted/cultivated	Row crops
C-348752	12200	Adams	132–163	40.0222	–91.2606	Planted/cultivated	Row crops
C-348387	13128	Alexander	0–5	37.3097	–89.4474	Planted/cultivated	Row crops
C-348797	13128	Alexander	0–17	37.3097	–89.4474	Planted/cultivated	Row crops
C-348558	13128	Alexander	125–163	37.3097	–89.4474	Planted/cultivated	Row crops
C-348407	11252	Bond	0–5	38.817	–89.522	Planted/cultivated	Row crops
C-348817	11252	Bond	0–9	38.817	–89.522	Planted/cultivated	Row crops
C-348578	11252	Bond	118–145	38.817	–89.522	Planted/cultivated	Row crops
C-348790	6200	Boone	0–5	42.2371	–88.9006	Planted/cultivated	Row crops
C-348677	6200	Boone	0–23	42.2371	–88.9006	Planted/cultivated	Row crops
C-348897	6200	Boone	70–102	42.2371	–88.9006	Planted/cultivated	Row crops
C-348772	6056	Bureau	0–5	41.3196	–89.3313	Forested upland	Deciduous forest
C-348660	6056	Bureau	0–3	41.3196	–89.3313	Forested upland	Deciduous forest
C-348879	6056	Bureau	120–149	41.3196	–89.3313	Forested upland	Deciduous forest
C-348913	3080	Calhoun	0–5	39.3303	–90.68	Planted/cultivated	Pasture/hay
C-348831	3080	Calhoun	0–18	39.3303	–90.68	Planted/cultivated	Pasture/hay
C-348482	3080	Calhoun	128–159	39.3303	–90.68	Planted/cultivated	Pasture/hay
C-348611	7848	Cass	0–5	39.8751	–90.0942	Planted/cultivated	Row crops
C-348638	7848	Cass	0–25	39.8751	–90.0942	Planted/cultivated	Row crops
C-348750	7848	Cass	130–160	39.8751	–90.0942	Planted/cultivated	Row crops
C-348583	2472	Champaign	0–5	40.3134	–88.0177	Planted/cultivated	Row crops
C-348590	2472	Champaign	0–20	40.3134	–88.0177	Planted/cultivated	Row crops
C-348597	2472	Champaign	120–140	40.3134		Planted/cultivated	Row crops
C-348604	7592	Champaign	0–5	39.9975	–88.1178	Planted/cultivated	Row crops
C-348631	7592	Champaign	0–20	39.9975	–88.1178	Planted/cultivated	Row crops
C-348743	7592	Champaign	120–140	39.9975	–88.1178	Planted/cultivated	Row crops
C-348605	9640	Champaign	0–5	40.0874	–88.345	Planted/cultivated	Row crops
C-348632	9640	Champaign	0–18	40.0874	–88.345	Planted/cultivated	Row crops
C-348744	9640	Champaign	120–148	40.0874	–88.345	Planted/cultivated	Row crops
C-348918	2036	Christian	0–5	39.4642	–89.4766	Planted/cultivated	Row crops
C-348836	2036	Christian	0–20	39.4642	–89.4766	Planted/cultivated	Row crops
C-348487	2036	Christian	115–153	39.4642	–89.4766	Planted/cultivated	Row crops
C-348919	6132	Christian	0–5	39.5482	–89.3165	Planted/cultivated	Urban/recreational grasses
C-348837	6132	Christian	0–18	39.5482	–89.3165	Planted/cultivated	Urban/recreational grasses
C-348488	6132	Christian	129–160	39.5482	–89.3165	Planted/cultivated	Urban/recreational grasses
C-348920	10228	Christian	0–5	39.4609	–89.0262	Planted/cultivated	Row crops
C-348838	10228	Christian	0–20	39.4609	–89.0262	Planted/cultivated	Row crops
C-348489	10228	Christian	111–150	39.4609	–89.0262	Planted/cultivated	Row crops
C-348908	492	Clark	0–5	39.4624	–87.6186	Planted/cultivated	Row crops
C-348826	492	Clark	0–21	39.4624	–87.6186	Planted/cultivated	Row crops
C-348477	492	Clark	121–154	39.4624	–87.6186	Planted/cultivated	Row crops
C-348923	4588	Clark	0–5	39.2952	–87.8667	Planted/cultivated	Row crops
C-348841	4588	Clark	0–18	39.2952	–87.8667	Planted/cultivated	Row crops
C-348492	4588	Clark	123–153	39.2952	–87.8667	Planted/cultivated	Row crops
C-348922	11500	Clark	0–5	39.4402	–87.8134	Planted/cultivated	Urban/recreational grasses
C-348840	11500	Clark	0–20	39.4402	–87.8134	Planted/cultivated	Urban/recreational grasses
C-348491	11500	Clark	116–153	39.4402	–87.8134	Planted/cultivated	Urban/recreational grasses
C-348403	1012	Clay	0–5	38.7971	–88.3103	Planted/cultivated	Row crops

*Continued on next page*

Electronic Filing: Received, Clerk's Office 3/24/2022

Lab no.	Site ID	County	Depth interval (cm)	Latitude	Longitude	Land cover	Land use
C-348813	1012	Clay	0-18	38.7971	-88.3103	Planted/cultivated	Row crops
C-348574	1012	Clay	120-145	38.7971	-88.3103	Planted/cultivated	Row crops
C-348904	10996	Clinton	0-5	38.5833	-89.5635	Planted/cultivated	Pasture/hay
C-348822	10996	Clinton	0-20	38.5833	-89.5635	Planted/cultivated	Pasture/hay
C-348473	10996	Clinton	118-157	38.5833	-89.5635	Planted/cultivated	Pasture/hay
C-348906	3060	Coles	0-5	39.612	-88.4521	Planted/cultivated	Row crops
C-348824	3060	Coles	0-20	39.612	-88.4521	Planted/cultivated	Row crops
C-348475	3060	Coles	125-156	39.612	-88.4521	Planted/cultivated	Row crops
C-348921	7156	Coles	0-5	39.4717	-88.1873	Planted/cultivated	Urban/recreational grasses
C-348839	7156	Coles	0-23	39.4717	-88.1873	Planted/cultivated	Urban/recreational grasses
C-348490	7156	Coles	120-160	39.4717	-88.1873	Planted/cultivated	Urban/recreational grasses
C-348786	1448	Cook	0-5	41.9003	-87.7032	Planted/cultivated	Urban/recreational grasses
C-348673	1448	Cook	0-23	41.9003	-87.7032	Planted/cultivated	Urban/recreational grasses
C-348893	1448	Cook	111-157	41.9003	-87.7032	Planted/cultivated	Urban/recreational grasses
C-348784	5544	Cook	0-5	41.6414	-87.8563	Forested upland	Mixed forest
C-348672	5544	Cook	0-17	41.6414	-87.8563	Forested upland	Mixed forest
C-348891	5544	Cook	82-156	41.6414	-87.8563	Forested upland	Mixed forest
C-348788	10296	Cook	0-5	42.0255	-87.992	Herbaceous upland	Grasslands/herbaceous
C-348675	10296	Cook	0-23	42.0255	-87.992	Herbaceous upland	Grasslands/herbaceous
C-348895	10296	Cook	109-142	42.0255	-87.992	Herbaceous upland	Grasslands/herbaceous
C-348404	8684	Crawford	0-5	38.9603	-87.9149	Planted/cultivated	Row crops
C-348814	8684	Crawford	0-18	38.9603	-87.9149	Planted/cultivated	Row crops
C-348575	8684	Crawford	130-154	38.9603	-87.9149	Planted/cultivated	Row crops
C-348682	4776	Dewitt	0-5	40.2257	-88.9453	Planted/cultivated	Row crops
C-348655	4776	Dewitt	0-20	40.2257	-88.9453	Planted/cultivated	Row crops
C-348767	4776	Dewitt	135-156	40.2257	-88.9453	Planted/cultivated	Row crops
C-348818	3496	Douglas	0-5	39.8311	-88.2362	Planted/cultivated	Row crops
C-348819	3496	Douglas	0-20	39.8311	-88.2362	Planted/cultivated	Row crops
C-348579	3496	Douglas	130-160	39.8311	-88.2362	Planted/cultivated	Row crops
C-348905	11688	Douglas	0-5	39.7184	-88.4092	Planted/cultivated	Pasture/hay
C-348823	11688	Douglas	0-22	39.7184	-88.4092	Planted/cultivated	Pasture/hay
C-348474	11688	Douglas	120-157	39.7184	-88.4092	Planted/cultivated	Pasture/hay
C-348907	6672	Edgar	0-5	39.6686	-87.6914	Planted/cultivated	Pasture/hay
C-348825	6672	Edgar	0-21	39.6686	-87.6914	Planted/cultivated	Pasture/hay
C-348476	6672	Edgar	115-160	39.6686	-87.6914	Planted/cultivated	Pasture/hay
C-348585	1704	Fulton	0-5	40.4737	-90.4341	Planted/cultivated	Row crops
C-348592	1704	Fulton	0-18	40.4737	-90.4341	Planted/cultivated	Row crops
C-348599	1704	Fulton	120-150	40.4737	-90.4341	Planted/cultivated	Row crops
C-348914	5384	Greene	0-5	39.5051	-90.1671	Herbaceous upland	Grasslands/herbaceous
C-348832	5384	Greene	0-10	39.5051	-90.1671	Herbaceous upland	Grasslands/herbaceous
C-348483	5384	Greene	124-150	39.5051	-90.1671	Herbaceous upland	Grasslands/herbaceous
C-348775	6312	Grundy	0-5	41.446	-88.5413	Planted/cultivated	Row crops
C-348663	6312	Grundy	0-18	41.446	-88.5413	Planted/cultivated	Row crops
C-348882	6312	Grundy	121-156	41.446	-88.5413	Planted/cultivated	Row crops
C-348776	11432	Grundy	0-5	41.1382	-88.5769	Planted/cultivated	Row crops
C-348664	11432	Grundy	0-23	41.1382	-88.5769	Planted/cultivated	Row crops
C-348883	11432	Grundy	130-160	41.1382	-88.5769	Planted/cultivated	Row crops
C-348397	7924	Hamilton	0-5	38.1185	-88.4933	Planted/cultivated	Pasture/hay
C-348807	7924	Hamilton	0-18	38.1185	-88.4933	Planted/cultivated	Pasture/hay
C-348568	7924	Hamilton	122-158	38.1185	-88.4933	Planted/cultivated	Pasture/hay
C-348615	8104	Hancock	0-5	40.3221	-91.2	Planted/cultivated	Row crops
C-348642	8104	Hancock	0-20	40.3221	-91.2	Planted/cultivated	Row crops
C-348754	8104	Hancock	120-158	40.3221	-91.2	Planted/cultivated	Row crops
C-348624	1256	Henderson	0-5	40.9574	-90.9429	Forested upland	Deciduous forest
C-348651	1256	Henderson	0-8	40.9574	-90.9429	Forested upland	Deciduous forest
C-348763	1256	Henderson	127-159	40.9574	-90.9429	Forested upland	Deciduous forest
C-348778	4520	Iroquois	0-5	40.9678	-88.0166	Planted/cultivated	Row crops

Continued on next page

Electronic Filing: Received, Clerk's Office 3/24/2022

Lab no.	Site ID	County	Depth interval (cm)	Latitude	Longitude	Land cover	Land use
C-348666	4520	Iroquois	0-15	40.9678	-88.0166	Planted/cultivated	Row crops
C-348885	4520	Iroquois	55-80	40.9678	-88.0166	Planted/cultivated	Row crops
C-348781	9744	Iroquois	0-5	40.7162	-87.6471	Planted/cultivated	Row crops
C-348669	9744	Iroquois	0-16	40.7162	-87.6471	Planted/cultivated	Row crops
C-348888	9744	Iroquois	119-159	40.7162	-87.6471	Planted/cultivated	Row crops
C-348396	3828	Jefferson	0-5	38.1544	-89.0082	Herbaceous upland	Grasslands/herbaceous
C-348806	3828	Jefferson	0-25	38.1544	-89.0082	Herbaceous upland	Grasslands/herbaceous
C-348567	3828	Jefferson	116-155	38.1544	-89.0082	Herbaceous upland	Grasslands/herbaceous
C-348794	8168	Jo Daviess	0-5	42.3644	-90.0343	Planted/cultivated	Row crops
C-348681	8168	Jo Daviess	0-25	42.3644	-90.0343	Planted/cultivated	Row crops
C-348901	8168	Jo Daviess	119-150	42.3644	-90.0343	Planted/cultivated	Row crops
C-348391	1780	Johnson	0-5	37.5698	-88.7224	Planted/cultivated	Urban/recreational grasses
C-348801	1780	Johnson	0-19	37.5698	-88.7224	Planted/cultivated	Urban/recreational grasses
C-348562	1780	Johnson	99-149	37.5698	-88.7224	Planted/cultivated	Urban/recreational grasses
C-348785	10408	Kane	0-5	41.8348	-88.3703	Herbaceous upland	Grasslands/herbaceous
C-348768	10408	Kane	0-20	41.8348	-88.3703	Herbaceous upland	Grasslands/herbaceous
C-348892	10408	Kane	60-107	41.8348	-88.3703	Herbaceous upland	Grasslands/herbaceous
C-348780	424	Kankakee	0-5	41.1977	-87.9717	Planted/cultivated	Urban/recreational grasses
C-348668	424	Kankakee	0-20	41.1977	-87.9717	Planted/cultivated	Urban/recreational grasses
C-348887	424	Kankakee	20-31	41.1977	-87.9717	Planted/cultivated	Urban/recreational grasses
C-348782	7952	Kankakee	0-5	41.0257	-87.5682	Planted/cultivated	Row crops
C-348670	7952	Kankakee	0-26	41.0257	-87.5682	Planted/cultivated	Row crops
C-348889	7952	Kankakee	110-154	41.0257	-87.5682	Planted/cultivated	Row crops
C-348777	8616	Kankakee	0-5	41.0359	-88.2486	Planted/cultivated	Row crops
C-348665	8616	Kankakee	0-28	41.0359	-88.2486	Planted/cultivated	Row crops
C-348884	8616	Kankakee	110-120	41.0359	-88.2486	Planted/cultivated	Row crops
C-348626	5800	Knox	0-5	40.8614	-90.4378	Planted/cultivated	Row crops
C-348653	5800	Knox	0-20	40.8614	-90.4378	Planted/cultivated	Row crops
C-348765	5800	Knox	117-150	40.8614	-90.4378	Planted/cultivated	Row crops
C-348620	10152	Knox	0-5	41.0237	-90.0622	Planted/cultivated	Pasture/hay
C-348647	10152	Knox	0-20	41.0237	-90.0622	Planted/cultivated	Pasture/hay
C-348759	10152	Knox	120-150	41.0237	-90.0622	Planted/cultivated	Pasture/hay
C-348774	3240	LaSalle	0-5	41.2671	-88.6948	Planted/cultivated	Row crops
C-348662	3240	LaSalle	0-18	41.2671	-88.6948	Planted/cultivated	Row crops
C-348881	3240	LaSalle	122-135	41.2671	-88.6948	Planted/cultivated	Row crops
C-348774	3240	LaSalle	0-5	41.2671	-88.6948	Planted/cultivated	Row crops
C-348662	3240	LaSalle	0-18	41.2671	-88.6948	Planted/cultivated	Row crops
C-348881	3240	LaSalle	122-135	41.2671	-88.6948	Planted/cultivated	Row crops
C-348773	7336	LaSalle	0-5	41.5197	-89.0827	Forested upland	Mixed forest
C-348661	7336	LaSalle	0-23	41.5197	-89.0827	Forested upland	Mixed forest
C-348880	7336	LaSalle	123-159	41.5197	-89.0827	Forested upland	Mixed forest
C-348791	5032	Lee	0-5	41.7693	-89.235	Planted/cultivated	Row crops
C-348678	5032	Lee	0-20	41.7693	-89.235	Planted/cultivated	Row crops
C-348898	5032	Lee	80-110	41.7693	-89.235	Planted/cultivated	Row crops
C-348792	9128	Lee	0-5	41.8475	-89.0969	Planted/cultivated	Pasture/hay
C-348679	9128	Lee	0-20	41.8475	-89.0969	Planted/cultivated	Pasture/hay
C-348899	9128	Lee	130-155	41.8475	-89.0969	Planted/cultivated	Pasture/hay
C-348586	680	Logan	0-5	40.3111	-89.3168	Planted/cultivated	Row crops
C-348593	680	Logan	0-20	40.3111	-89.3168	Planted/cultivated	Row crops
C-348600	680	Logan	125-140	40.3111	-89.3168	Planted/cultivated	Row crops
C-348609	8872	Logan	0-5	39.9688	-89.3873	Planted/cultivated	Row crops
C-348636	8872	Logan	0-20	39.9688	-89.3873	Planted/cultivated	Row crops
C-348748	8872	Logan	120-157	39.9688	-89.3873	Planted/cultivated	Row crops
C-348911	264	Madison	0-5	38.8895	-89.6857	Planted/cultivated	Row crops
C-348829	264	Madison	0-21	38.8895	-89.6857	Planted/cultivated	Row crops
C-348480	264	Madison	121-158	38.8895	-89.6857	Planted/cultivated	Row crops
C-348406	4084	Marion	0-5	38.7366	-89.1244	Planted/cultivated	Pasture/hay

Continued on next page



Electronic Filing: Received, Clerk's Office 3/24/2022

Lab no.	Site ID	County	Depth interval (cm)	Latitude	Longitude	Land cover	Land use
C-348816	4084	Marion	0-20	38.7366	-89.1244	Planted/cultivated	Pasture/hay
C-348577	4084	Marion	117-151	38.7366	-89.1244	Planted/cultivated	Pasture/hay
C-348405	5108	Marion	0-5	38.7209	-88.752	Forested upland	Deciduous forest
C-348815	5108	Marion	0-18	38.7209	-88.752	Forested upland	Deciduous forest
C-348576	5108	Marion	121-156	38.7209	-88.752	Forested upland	Deciduous forest
C-348619	1960	Marshall	0-5	41.0609	-89.5918	Planted/cultivated	Row crops
C-348646	1960	Marshall	0-25	41.0609	-89.5918	Planted/cultivated	Row crops
C-348758	1960	Marshall	114-155	41.0609	-89.5918	Planted/cultivated	Row crops
C-348606	6568	McLean	0-5	40.5596	-88.7989	Planted/cultivated	Row crops
C-348633	6568	McLean	0-23	40.5596	-88.7989	Planted/cultivated	Row crops
C-348745	6568	McLean	136-157	40.5596	-88.7989	Planted/cultivated	Row crops
C-348587	6824	McDonough	0-5	40.4299	-90.4483	Planted/cultivated	Pasture/hay
C-348594	6824	McDonough	0-25	40.4299	-90.4483	Planted/cultivated	Pasture/hay
C-348601	6824	McDonough	130-150	40.4299	-90.4483	Planted/cultivated	Pasture/hay
C-348625	12968	McDonough	0-5	40.5208	-90.7135	Barren	Transitional
C-348652	12968	McDonough	0-25	40.5208	-90.7135	Barren	Transitional
C-348764	12968	McDonough	122-159	40.5208	-90.7135	Barren	Transitional
C-348789	2104	McHenry	0-5	42.4228	-88.3066	Herbaceous upland	Grasslands/herbaceous
C-348676	2104	McHenry	0-20	42.4228	-88.3066	Herbaceous upland	Grasslands/herbaceous
C-348896	2104	McHenry	102-154	42.4228	-88.3066	Herbaceous upland	Grasslands/herbaceous
C-348607	10664	McLean	0-5	40.6165	-88.8123	Planted/cultivated	Row crops
C-348634	10664	McLean	0-19	40.6165	-88.8123	Planted/cultivated	Row crops
C-348746	10664	McLean	124-159	40.6165	-88.8123	Planted/cultivated	Row crops
C-348623	3816	Mercer	0-5	41.3091	-91.0038	Planted/cultivated	Pasture/hay
C-348650	3816	Mercer	0-20	41.3091	-91.0038	Planted/cultivated	Pasture/hay
C-348762	3816	Mercer	125-153	41.3091	-91.0038	Planted/cultivated	Pasture/hay
C-348916	1288	Montgomery	0-5	39.2797	-89.6607	Planted/cultivated	Pasture/hay
C-348834	1288	Montgomery	0-18	39.2797	-89.6607	Planted/cultivated	Pasture/hay
C-348485	1288	Montgomery	110-153	39.2797	-89.6607	Planted/cultivated	Pasture/hay
C-348912	7176	Morgan	0-5	39.6541	-90.2838	Forested upland	Mixed forest
C-348830	7176	Morgan	0-25	39.6541	-90.2838	Forested upland	Mixed forest
C-348481	7176	Morgan	121-151	39.6541	-90.2838	Forested upland	Mixed forest
C-348915	9480	Morgan	0-5	39.5418	-90.034	Planted/cultivated	Row crops
C-348833	9480	Morgan	0-25	39.5418	-90.034	Planted/cultivated	Row crops
C-348484	9480	Morgan	124-157	39.5418	-90.034	Planted/cultivated	Row crops
C-348618	3752	Peoria	0-5	40.9175	-89.6396	Planted/cultivated	Row crops
C-348645	3752	Peoria	0-25	40.9175	-89.6396	Planted/cultivated	Row crops
C-348757	3752	Peoria	129-160	40.9175	-89.6396	Planted/cultivated	Row crops
C-348612	10248	Pike	0-5	39.7917	-90.6572	Planted/cultivated	Row crops
C-348639	10248	Pike	0-23	39.7917	-90.6572	Planted/cultivated	Row crops
C-348751	10248	Pike	120-153	39.7917	-90.6572	Planted/cultivated	Row crops
C-348392	13044	Pope	0-5	37.5943	-88.4315	Forested upland	Deciduous forest
C-348802	13044	Pope	0-2	37.5943	-88.4315	Forested upland	Deciduous forest
C-348563	13044	Pope	89-115	37.5943	-88.4315	Forested upland	Deciduous forest
C-348388	2804	Randolph	0-5	37.9019	-89.8154	Planted/cultivated	Urban/recreational grasses
C-348798	2804	Randolph	0-19	37.9019	-89.8154	Planted/cultivated	Urban/recreational grasses
C-348559	2804	Randolph	124-151	37.9019	-89.8154	Planted/cultivated	Urban/recreational grasses
C-348389	8200	Randolph	0-5	38.062	-90.0358	Planted/cultivated	Row crops
C-348799	8200	Randolph	0-20	38.062	-90.0358	Planted/cultivated	Row crops
C-348560	8200	Randolph	120-160	38.062	-90.0358	Planted/cultivated	Row crops
C-348402	1516	Richland	0-5	38.6902	-87.9456	Planted/cultivated	Pasture/hay
C-348812	1516	Richland	0-18	38.6902	-87.9456	Planted/cultivated	Pasture/hay
C-348573	1516	Richland	123-160	38.6902	-87.9456	Planted/cultivated	Pasture/hay
C-348394	9972	Saline	0-5	37.666	-88.5551	Planted/cultivated	Pasture/hay
C-348804	9972	Saline	0-22	37.6666	-88.5551	Planted/cultivated	Pasture/hay
C-348565	9972	Saline	130-159	37.6666	-88.5551	Planted/cultivated	Pasture/hay
C-348610	11944	Sangamon	0-5	39.7973	-89.7578	Planted/cultivated	Pasture/hay
C-348637	11944	Sangamon	0-23	39.7973	-89.7578	Planted/cultivated	Pasture/hay

Continued on next page

Electronic Filing: Received, Clerk's Office 3/24/2022

Lab no.	Site ID	County	Depth interval (cm)	Latitude	Longitude	Land cover	Land use
C-348749	11944	Sangamon	126-153	39.7973	-89.7578	Planted/cultivated	Pasture/hay
C-348616	2728	Schuyler	0-5	40.2298	-90.8907	Herbaceous upland	Grasslands/herbaceous
C-348643	2728	Schuyler	0-20	40.2298	-90.8907	Herbaceous upland	Grasslands/herbaceous
C-348755	2728	Schuyler	131-159	40.2298	-90.8907	Herbaceous upland	Grasslands/herbaceous
C-348909	4104	St. Clair	0-5	38.506	-89.756	Planted/cultivated	Row crops
C-348827	4104	St. Clair	0-20	38.506	-89.756	Planted/cultivated	Row crops
C-348478	4104	St. Clair	117-157	38.506	-89.756	Planted/cultivated	Row crops
C-348621	4008	Stephenson	0-5	41.211	-90.197	Planted/cultivated	Row crops
C-348648	4008	Stephenson	0-20	41.211	-90.197	Planted/cultivated	Row crops
C-348760	4008	Stephenson	121-153	41.211	-90.197	Planted/cultivated	Row crops
C-348793	5096	Stephenson	0-5	42.241	-89.6503	Planted/cultivated	Row crops
C-348680	5096	Stephenson	0-25	42.241	-89.6503	Planted/cultivated	Row crops
C-348900	5096	Stephenson	132-160	42.241	-89.6503	Planted/cultivated	Row crops
C-348603	9192	Stephenson	0-5	42.4849	-89.703	Planted/cultivated	Row crops
C-348630	9192	Stephenson	0-17	42.4849	-89.703	Planted/cultivated	Row crops
C-348742	9192	Stephenson	118-147	42.4849	-89.703	Planted/cultivated	Row crops
C-348617	10920	Tazewell	0-5	40.5935	-89.6424	Forested upland	Deciduous forest
C-348644	10920	Tazewell	0-12	40.5935	-89.6424	Forested upland	Deciduous forest
C-348756	10920	Tazewell	123-157	40.5935	-89.6424	Forested upland	Deciduous forest
C-348401	9204	Wayne	0-5	38.501	-88.4292	Planted/cultivated	Pasture/hay
C-348811	9204	Wayne	0-9	38.501	-88.4292	Planted/cultivated	Pasture/hay
C-348572	9204	Wayne	119-153	38.501	-88.4292	Planted/cultivated	Pasture/hay
C-348400	12020	White	0-5	38.1839	-88.3259	Planted/cultivated	Row crops
C-348810	12020	White	0-20	38.1839	-88.3259	Planted/cultivated	Row crops
C-348571	12020	White	119-150	38.1839	-88.3259	Planted/cultivated	Row crops
C-348398	5356	White	0-5	38.2136	-88.1738	Planted/cultivated	Row crops
C-348808	5356	White	0-18	38.2136	-88.1738	Planted/cultivated	Row crops
C-348569	5356	White	117-150	38.2136	-88.1738	Planted/cultivated	Row crops
C-348771	936	Whiteside	0-5	41.6734	-89.9209	Planted/cultivated	Urban/recreational grasses
C-348659	936	Whiteside	0-20	41.6734	-89.9209	Planted/cultivated	Urban/recreational grasses
C-348878	936	Whiteside	121-150	41.6734	-89.9209	Planted/cultivated	Urban/recreational grasses
C-348627	7080	Whiteside	0-5	41.5848	-90.1458	Planted/cultivated	Row crops
C-348654	7080	Whiteside	0-20	41.5848	-90.1458	Planted/cultivated	Row crops
C-348766	7080	Whiteside	125-161	41.5848	-90.1458	Planted/cultivated	Row crops
C-348783	12712	Will	0-5	41.6085	-88.1795	Herbaceous upland	Grasslands/herbaceous
C-348671	12712	Will	0-8	41.6085	-88.1795	Herbaceous upland	Grasslands/herbaceous
C-348890	12712	Will	18-29	41.6085	-88.1795	Herbaceous upland	Grasslands/herbaceous
C-348395	5876	Williamson	0-5	37.762	-88.7798	Planted/cultivated	Pasture/hay
C-348805	5876	Williamson	0-19	37.762	-88.7798	Planted/cultivated	Pasture/hay
C-348566	5876	Williamson	122-160	37.762	-88.7798	Planted/cultivated	Pasture/hay
C-348390	6900	Williamson	0-5	37.6374	-89.0542	Forested upland	Mixed forest
C-348800	6900	Williamson	0-18	37.6374	-89.0542	Forested upland	Mixed forest
C-348561	6900	Williamson	89-125	37.6374	-89.0542	Forested upland	Mixed forest

Continued on next page

Electronic Filing: Received, Clerk's Office 3/24/2022

Lab no.	Site ID	County	Al <sub>2</sub> O <sub>3</sub> (wt%)	Fe <sub>2</sub> O <sub>3</sub> (wt%)	MgO (wt%)	CaO (wt%)	NaO (wt%)	K <sub>2</sub> O (wt%)	TiO <sub>2</sub> (wt%)	SO <sub>3</sub> (wt%)	P <sub>2</sub> O <sub>5</sub> (wt%)
C-348582	9896	Adams	10.28	4.68	1.04	0.97	1.20	2.39	0.65	1.62	0.15
C-348589	9896	Adams	7.31	2.25	0.46	0.84	1.15	1.93	0.58	0.07	0.17
C-348596	9896	Adams	7.14	2.15	0.45	0.90	1.15	1.90	0.57	0.07	0.18
C-348613	12200	Adams	8.24	2.57	0.73	1.76	1.01	1.88	0.52	1.29	0.18
C-348640	12200	Adams	8.86	2.85	0.63	1.50	1.08	1.99	0.50	0.07	0.16
C-348752	12200	Adams	11.11	4.48	1.01	0.91	1.17	2.07	0.57	0.05	0.15
C-348387	13128	Alexander	9.31	2.59	0.88	1.34	1.39	2.36	0.38	0.96	0.26
C-348797	13128	Alexander	9.07	2.50	0.86	1.20	1.27	2.10	0.42	0.12	0.22
C-348558	13128	Alexander	15.11	5.26	2.22	2.27	0.55	2.43	0.67	0.12	0.16
C-348407	11252	Bond	8.67	3.13	0.78	1.04	0.97	2.01	0.48	1.21	0.19
C-348817	11252	Bond	8.42	2.96	0.73	0.91	0.90	1.89	0.52	0.07	0.16
C-348578	11252	Bond	9.29	3.20	0.73	0.63	1.02	1.86	0.63	0.05	0.06
C-348790	6200	Boone	8.01	2.70	1.09	1.47	0.81	1.78	0.45	1.12	0.14
C-348677	6200	Boone	8.10	2.76	0.99	1.33	0.82	1.77	0.43	0.10	0.12
C-348897	6200	Boone	7.82	3.65	1.46	1.57	0.65	1.55	0.32	0.05	0.09
C-348772	6056	Bureau	6.42	2.30	3.15	5.53	0.74	2.01	0.32	0.79	0.14
C-348660	6056	Bureau	6.86	2.43	3.42	6.00	0.75	2.07	0.32	0.17	0.14
C-348879	6056	Bureau	5.10	1.94	3.35	6.02	0.63	1.86	0.18	0.07	0.07
C-348913	3080	Calhoun	7.23	1.77	0.36	0.90	1.23	1.96	0.48	1.21	0.14
C-348831	3080	Calhoun	7.29	1.82	0.35	0.74	1.24	2.02	0.52	0.05	0.13
C-348482	3080	Calhoun	10.07	4.20	0.85	0.85	1.28	2.16	0.52	0.05	0.14
C-348611	7848	Cass	8.41	2.77	0.70	0.99	0.90	2.01	0.52	1.29	0.20
C-348638	7848	Cass	8.84	3.03	0.61	0.92	0.93	2.12	0.47	0.10	0.18
C-348750	7848	Cass	8.86	3.86	3.83	5.08	1.01	1.96	0.45	0.05	0.12
C-348583	2472	Champaign	11.28	4.92	1.43	0.76	0.86	3.02	0.60	1.50	0.14
C-348590	2472	Champaign	10.07	3.30	1.09	1.02	0.75	2.11	0.55	0.12	0.17
C-348597	2472	Champaign	9.27	3.00	1.01	0.94	0.71	2.02	0.52	0.12	0.17
C-348604	7592	Champaign	9.16	3.17	0.86	0.90	0.82	2.07	0.55	1.37	0.19
C-348631	7592	Champaign	8.93	3.12	0.70	0.73	0.81	2.05	0.45	0.12	0.15
C-348743	7592	Champaign	8.29	3.26	4.24	5.36	0.78	2.52	0.38	0.07	0.06
C-348605	9640	Champaign	8.46	2.67	0.81	0.78	0.80	2.29	0.50	1.25	0.21
C-348632	9640	Champaign	8.25	2.59	0.66	0.62	0.78	2.29	0.43	0.10	0.17
C-348744	9640	Champaign	12.11	4.83	1.56	0.48	0.62	2.68	0.50	0.05	0.07
C-348918	2036	Christian	8.50	2.87	0.61	1.52	0.89	1.99	0.43	1.08	0.24
C-348836	2036	Christian	8.82	3.00	0.65	1.44	0.93	2.12	0.48	0.12	0.23
C-348487	2036	Christian	10.31	4.85	0.93	0.90	1.16	2.34	0.53	0.05	0.16
C-348919	6132	Christian	9.07	6.44	0.58	1.11	0.89	1.54	0.42	1.04	0.23
C-348837	6132	Christian	10.94	12.10	0.65	1.62	1.05	1.48	0.50	0.90	0.30
C-348488	6132	Christian	9.97	3.19	0.83	0.99	1.21	1.98	0.53	0.02	0.13
C-348920	10228	Christian	6.99	2.15	0.41	0.73	1.05	1.90	0.43	1.08	0.21
C-348838	10228	Christian	6.82	2.19	0.43	0.74	1.00	1.69	0.45	0.10	0.24
C-348489	10228	Christian	11.16	4.42	1.09	0.83	1.08	2.24	0.53	0.05	0.14
C-348908	492	Clark	7.67	2.49	0.50	0.91	1.09	2.04	0.43	1.08	0.13
C-348826	492	Clark	8.29	2.69	0.50	0.80	1.12	1.92	0.52	0.05	0.13
C-348477	492	Clark	10.84	4.16	0.86	0.83	1.20	2.16	0.52	0.02	0.14
C-348923	4588	Clark	7.46	2.20	0.45	0.87	0.98	1.77	0.45	1.12	0.13
C-348841	4588	Clark	7.61	2.27	0.46	0.94	1.01	1.81	0.48	0.12	0.13
C-348492	4588	Clark	10.60	3.62	0.71	0.81	1.06	1.82	0.48	0.07	0.08
C-348922	11500	Clark	7.01	2.49	0.40	0.56	0.81	1.76	0.43	1.08	0.15
C-348840	11500	Clark	7.23	2.56	0.41	0.50	0.82	1.81	0.48	0.05	0.12
C-348491	11500	Clark	8.97	2.76	0.58	0.55	0.82	1.64	0.45	0.02	0.04
C-348403	1012	Clay	7.69	2.47	0.45	0.42	0.70	1.47	0.38	0.96	0.18
C-348813	1012	Clay	7.71	2.66	0.40	0.38	0.69	1.39	0.43	0.05	0.14
C-348574	1012	Clay	7.67	3.02	3.33	5.22	0.86	1.93	0.38	0.10	0.09
C-348904	10996	Clinton	6.91	2.42	0.61	2.77	0.98	1.63	0.38	0.96	0.31
C-348822	10996	Clinton	7.69	2.86	0.68	3.37	1.08	1.88	0.45	0.15	0.34

Continued on next page

Electronic Filing: Received, Clerk's Office 3/24/2022

Lab no.	Site ID	County	Al <sub>2</sub> O <sub>3</sub> (wt%)	Fe <sub>2</sub> O <sub>3</sub> (wt%)	MgO (wt%)	CaO (wt%)	NaO (wt%)	K <sub>2</sub> O (wt%)	TiO <sub>2</sub> (wt%)	SO <sub>3</sub> (wt%)	P <sub>2</sub> O <sub>5</sub> (wt%)
C-348473	10996	Clinton	11.58	3.85	0.99	0.92	1.35	2.29	0.55	0.07	0.16
C-348906	3060	Coles	8.63	3.00	0.70	0.66	0.82	2.11	0.45	1.12	0.17
C-348824	3060	Coles	9.09	3.13	0.73	0.64	0.84	1.98	0.50	0.07	0.18
C-348475	3060	Coles	10.96	4.19	3.86	4.59	0.70	3.60	0.47	0.05	0.08
C-348921	7156	Coles	4.89	1.33	0.91	1.59	0.74	1.71	0.18	0.46	0.07
C-348839	7156	Coles	5.01	1.44	0.98	1.64	0.74	1.75	0.22	0.07	0.06
C-348490	7156	Coles	5.52	1.70	1.11	1.90	0.75	1.80	0.23	0.12	0.05
C-348786	1448	Cook	9.58	3.58	1.72	2.34	0.65	2.35	0.40	1.00	0.20
C-348673	1448	Cook	10.39	3.83	1.59	2.06	0.74	2.25	0.40	0.22	0.19
C-348893	1448	Cook	11.64	4.42	4.23	7.12	0.55	1.82	0.40	0.15	0.08
C-348784	5544	Cook	8.29	2.97	0.76	0.62	0.78	2.27	0.40	1.00	0.07
C-348672	5544	Cook	8.01	2.87	0.76	0.64	0.77	2.40	0.37	0.05	0.06
C-348891	5544	Cook	10.99	4.68	4.64	6.17	0.62	1.61	0.45	0.10	0.07
C-348788	10296	Cook	9.80	3.49	1.01	1.02	0.74	2.23	0.47	1.17	0.16
C-348675	10296	Cook	10.13	3.72	0.96	1.05	0.78	2.16	0.48	0.12	0.15
C-348895	10296	Cook	11.94	4.49	5.65	9.04	0.61	1.80	0.42	0.07	0.08
C-348404	8684	Crawford	7.48	2.87	0.58	1.04	0.85	1.80	0.47	1.17	0.34
C-348814	8684	Crawford	7.54	2.82	0.53	0.90	0.81	1.57	0.48	0.07	0.29
C-348575	8684	Crawford	7.37	2.69	0.58	0.53	0.82	1.74	0.53	0.05	0.06
C-348682	4776	Dewitt	8.82	3.09	0.75	1.18	0.93	2.24	0.50	1.25	0.40
C-348655	4776	Dewitt	8.75	3.09	0.70	1.09	0.92	2.25	0.48	0.12	0.47
C-348767	4776	Dewitt	8.90	3.43	4.08	5.96	0.63	2.39	0.38	0.07	0.07
C-348818	3496	Douglas	8.76	3.00	0.70	0.71	0.84	2.14	0.45	1.12	0.27
C-348819	3496	Douglas	8.93	3.07	0.71	0.70	0.82	1.87	0.45	0.07	0.25
C-348579	3496	Douglas	6.29	2.22	0.60	0.62	0.82	1.95	0.28	0.02	0.07
C-348905	11688	Douglas	8.44	2.85	0.66	1.01	0.86	1.65	0.43	1.08	0.21
C-348823	11688	Douglas	8.73	3.03	0.68	1.05	0.88	2.11	0.47	0.10	0.22
C-348474	11688	Douglas	10.18	4.00	2.84	3.05	0.86	3.11	0.45	0.05	0.09
C-348907	6672	Edgar	5.38	2.83	0.70	2.07	0.50	1.55	0.28	0.71	0.73
C-348825	6672	Edgar	6.37	2.46	0.68	1.72	0.61	1.69	0.38	0.35	0.76
C-348476	6672	Edgar	8.80	3.39	1.87	1.90	0.84	2.48	0.33	0.05	0.08
C-348585	1704	Fulton	9.60	3.99	1.09	0.99	1.06	1.87	0.58	1.46	0.18
C-348592	1704	Fulton	7.56	2.23	0.48	0.64	1.15	1.92	0.63	0.07	0.14
C-348599	1704	Fulton	7.27	2.15	0.46	0.62	1.11	1.88	0.60	0.07	0.16
C-348914	5384	Greene	7.42	2.52	0.46	0.78	0.88	1.90	0.42	1.04	0.41
C-348832	5384	Greene	7.25	2.53	0.40	0.53	0.74	1.82	0.43	0.07	0.33
C-348483	5384	Greene	12.56	5.09	1.48	0.50	0.61	3.17	0.50	0.05	0.06
C-348775	6312	Grundy	8.97	3.03	0.95	1.36	0.85	1.78	0.48	1.21	0.20
C-348663	6312	Grundy	8.63	2.89	0.83	1.16	0.82	1.69	0.45	0.12	0.21
C-348882	6312	Grundy	5.80	2.30	6.28	10.77	0.84	1.81	0.23	0.07	0.08
C-348776	11432	Grundy	9.46	3.19	0.88	1.08	0.88	1.94	0.47	1.17	0.33
C-348664	11432	Grundy	10.22	3.52	0.98	1.13	0.90	2.33	0.48	0.12	0.34
C-348883	11432	Grundy	12.35	5.13	1.38	0.91	0.97	2.93	0.53	0.05	0.16
C-348397	7924	Hamilton	7.08	2.52	0.43	0.53	0.71	1.72	0.47	1.17	0.28
C-348807	7924	Hamilton	8.10	2.77	0.46	0.50	0.75	1.74	0.60	0.10	0.19
C-348568	7924	Hamilton	10.90	3.86	0.90	0.60	1.20	2.12	0.73	0.07	0.10
C-348615	8104	Hancock	8.12	2.22	0.68	1.32	1.01	1.84	0.52	1.29	0.35
C-348642	8104	Hancock	7.99	2.33	0.63	1.40	0.97	1.83	0.45	0.12	0.41
C-348754	8104	Hancock	10.82	4.72	0.65	0.46	0.40	1.07	0.45	0.05	0.03
C-348624	1256	Henderson	5.04	1.36	0.40	1.45	1.02	1.33	0.22	0.54	0.10
C-348651	1256	Henderson	4.80	1.26	0.30	1.06	1.00	1.29	0.15	0.07	0.08
C-348763	1256	Henderson	4.80	1.26	0.28	0.64	1.06	1.31	0.15	<0.03	0.03
C-348778	4520	Iroquois	8.93	3.20	0.95	0.88	0.65	2.25	0.43	1.08	0.16
C-348666	4520	Iroquois	9.41	3.46	0.96	0.87	0.65	2.42	0.43	0.12	0.14
C-348885	4520	Iroquois	11.28	4.58	4.31	7.37	0.47	2.99	0.48	0.10	0.06
C-348781	9744	Iroquois	8.42	2.59	0.66	0.83	0.86	1.94	0.42	1.04	0.21
C-348669	9744	Iroquois	8.46	2.63	0.65	0.81	0.85	2.01	0.40	0.10	0.20
C-348888	9744	Iroquois	9.18	3.86	2.42	3.72	1.01	2.43	0.37	0.07	0.11

Continued on next page



Electronic Filing: Received, Clerk's Office 3/24/2022

Lab no.	Site ID	County	Al <sub>2</sub> O <sub>3</sub> (wt%)	Fe <sub>2</sub> O <sub>3</sub> (wt%)	MgO (wt%)	CaO (wt%)	NaO (wt%)	K <sub>2</sub> O (wt%)	TiO <sub>2</sub> (wt%)	SO <sub>3</sub> (wt%)	P <sub>2</sub> O <sub>5</sub> (wt%)
C-348396	3828	Jefferson	7.35	2.73	0.38	0.57	0.96	1.61	0.48	1.21	0.20
C-348806	3828	Jefferson	7.44	2.47	0.38	0.52	0.92	1.52	0.53	0.05	0.12
C-348567	3828	Jefferson	9.86	3.49	0.70	0.57	0.94	1.76	0.65	0.07	0.08
C-348794	8168	Jo Daviess	8.80	3.05	1.49	2.03	0.93	1.83	0.48	1.21	0.30
C-348681	8168	Jo Daviess	9.27	3.12	1.44	1.92	1.01	2.11	0.48	0.10	0.33
C-348901	8168	Jo Daviess	13.75	5.18	2.57	2.20	0.43	1.81	0.53	0.07	0.26
C-348391	1780	Johnson	8.50	3.06	0.50	0.34	0.78	1.95	0.53	1.33	0.12
C-348801	1780	Johnson	8.50	2.96	0.50	0.32	0.73	1.80	0.62	0.07	0.09
C-348562	1780	Johnson	8.97	3.23	0.76	0.64	1.17	1.94	0.63	0.05	0.06
C-348785	10408	Kane	8.67	2.96	0.76	0.92	0.94	2.08	0.50	1.25	0.40
C-348768	10408	Kane	8.84	3.00	0.78	0.85	0.97	2.14	0.52	0.12	0.39
C-348892	10408	Kane	10.07	5.11	6.98	8.53	0.54	2.02	0.42	0.10	0.11
C-348780	424	Kankakee	8.22	3.15	1.06	1.45	0.77	1.80	0.42	1.04	0.15
C-348668	424	Kankakee	8.58	3.29	0.96	1.19	0.78	1.84	0.40	0.10	0.14
C-348887	424	Kankakee	10.77	4.72	1.53	1.34	0.70	1.95	0.42	0.07	0.10
C-348782	7952	Kankakee	4.04	1.90	0.30	0.67	0.67	1.24	0.15	0.37	0.11
C-348670	7952	Kankakee	4.51	2.16	0.32	0.73	0.73	1.35	0.15	0.05	0.14
C-348889	7952	Kankakee	3.66	0.44	0.15	0.35	0.73	1.39	0.05	<0.03	0.01
C-348777	8616	Kankakee	8.76	3.33	1.64	2.27	0.58	1.70	0.42	1.04	0.18
C-348665	8616	Kankakee	8.92	3.35	1.56	2.01	0.59	2.30	0.38	0.12	0.15
C-348884	8616	Kankakee	10.99	4.96	5.22	6.16	0.46	2.53	0.47	0.10	0.06
C-348626	5800	Knox	8.41	2.60	0.68	1.09	1.02	1.90	0.52	1.29	0.18
C-348653	5800	Knox	9.48	3.00	0.65	0.95	1.09	2.04	0.50	0.07	0.14
C-348765	5800	Knox	10.54	4.25	1.03	0.98	1.15	1.98	0.53	0.05	0.15
C-348620	10152	Knox	11.62	4.78	2.84	10.35	0.38	2.65	0.52	1.29	0.34
C-348647	10152	Knox	12.01	4.63	2.42	9.28	0.35	2.60	0.50	1.67	0.26
C-348759	10152	Knox	11.07	4.35	1.87	1.82	0.96	1.94	0.53	0.17	0.09
C-348774	3240	LaSalle	11.03	4.12	1.62	1.72	0.73	2.36	0.53	1.33	0.15
C-348662	3240	LaSalle	10.98	4.08	1.72	1.96	0.73	2.57	0.52	0.10	0.14
C-348881	3240	LaSalle	10.16	4.36	6.42	8.56	0.46	2.89	0.42	0.12	0.07
C-348773	7336	LaSalle	8.24	2.56	1.81	2.77	1.02	1.87	0.43	1.08	0.16
C-348661	7336	LaSalle	8.39	2.62	1.84	2.70	1.05	1.89	0.43	0.12	0.16
C-348880	7336	LaSalle	6.54	2.17	2.40	4.50	0.81	1.66	0.28	0.10	0.13
C-348791	5032	Lee	7.84	2.53	2.04	2.83	0.73	2.27	0.38	0.96	0.26
C-348678	5032	Lee	8.48	2.73	1.53	1.97	0.77	2.34	0.40	0.10	0.30
C-348898	5032	Lee	7.63	1.93	1.64	2.03	0.50	2.19	0.28	0.05	0.06
C-348792	9128	Lee	8.86	2.93	0.78	0.95	0.89	1.80	0.47	1.17	0.18
C-348679	9128	Lee	8.80	2.95	0.75	0.84	0.90	1.70	0.47	0.12	0.15
C-348899	9128	Lee	6.93	2.65	3.91	5.67	0.73	1.82	0.27	0.05	0.07
C-348586	680	Logan	8.59	2.83	0.73	1.33	0.92	1.99	0.55	1.37	0.18
C-348593	680	Logan	8.46	2.80	0.70	0.87	0.86	1.93	0.53	0.10	0.14
C-348600	680	Logan	9.29	3.76	2.57	3.16	1.08	2.16	0.53	0.10	0.15
C-348609	8872	Logan	7.93	2.45	0.60	0.80	1.04	2.24	0.55	1.37	0.22
C-348636	8872	Logan	8.08	2.49	0.50	0.53	1.04	2.24	0.48	0.07	0.16
C-348748	8872	Logan	11.01	4.55	0.99	0.69	0.98	2.14	0.57	0.05	0.12
C-348911	264	Madison	6.69	2.73	0.40	1.23	1.06	1.77	0.40	1.00	0.55
C-348829	264	Madison	6.74	2.65	0.41	1.30	1.06	1.72	0.42	0.15	0.52
C-348480	264	Madison	10.18	3.09	0.70	0.90	1.27	2.18	0.53	0.05	0.10
C-348406	4084	Marion	5.86	2.25	0.50	1.55	0.84	1.47	0.37	0.92	0.66
C-348816	4084	Marion	6.82	2.43	0.38	0.87	0.93	1.54	0.45	0.12	0.30
C-348577	4084	Marion	8.27	2.80	0.65	0.78	1.09	1.75	0.55	0.10	0.08
C-348405	5108	Marion	7.18	2.02	0.38	0.35	0.88	1.98	0.52	1.29	0.10
C-348815	5108	Marion	7.57	2.12	0.38	0.22	0.88	1.82	0.58	0.05	0.07
C-348576	5108	Marion	7.40	2.43	0.55	0.38	0.80	1.65	0.57	0.05	0.03
C-348619	1960	Marshall	8.93	2.97	0.85	1.16	0.85	1.92	0.55	1.37	0.21
C-348646	1960	Marshall	9.05	3.00	0.71	1.01	0.86	1.92	0.48	0.10	0.18
C-348758	1960	Marshall	10.73	4.48	1.51	1.66	1.15	2.06	0.52	0.05	0.12
C-348606	6568	McLean	9.46	3.60	0.88	0.90	0.92	2.34	0.55	1.37	0.22

Continued on next page

Electronic Filing: Received, Clerk's Office 3/24/2022

Lab no.	Site ID	County	Al <sub>2</sub> O <sub>3</sub> (wt%)	Fe <sub>2</sub> O <sub>3</sub> (wt%)	MgO (wt%)	CaO (wt%)	NaO (wt%)	K <sub>2</sub> O (wt%)	TiO <sub>2</sub> (wt%)	SO <sub>3</sub> (wt%)	P <sub>2</sub> O <sub>5</sub> (wt%)
C-348633	6568	McLean	8.92	3.32	0.71	0.71	0.88	2.31	0.43	0.10	0.20
C-348745	6568	McLean	11.83	4.53	1.26	0.66	0.80	2.41	0.50	0.05	0.06
C-348587	6824	McDonough	8.03	2.69	0.66	1.13	0.89	1.80	0.53	1.33	0.18
C-348594	6824	McDonough	8.82	2.93	0.71	0.99	0.94	1.94	0.58	0.12	0.16
C-348601	6824	McDonough	9.39	3.25	0.90	1.01	1.05	1.67	0.58	0.05	0.11
C-348625	12968	McDonough	7.03	2.30	0.55	0.99	1.02	1.83	0.50	1.25	0.25
C-348652	12968	McDonough	7.73	2.56	0.50	0.80	1.04	1.93	0.48	0.10	0.19
C-348764	12968	McDonough	10.81	3.88	0.99	0.92	1.13	1.96	0.55	0.05	0.13
C-348789	2104	McHenry	9.24	3.56	1.14	1.09	0.59	1.94	0.45	1.12	0.14
C-348676	2104	McHenry	9.60	3.63	1.03	0.85	0.62	2.24	0.43	0.10	0.13
C-348896	2104	McHenry	8.48	3.20	8.69	15.11	0.46	1.83	0.35	0.07	0.08
C-348607	10664	McLean	9.29	3.30	0.88	1.22	0.80	1.99	0.53	1.33	0.18
C-348634	10664	McLean	9.79	3.45	0.76	0.98	0.84	2.08	0.48	0.07	0.14
C-348746	10664	McLean	7.37	3.05	4.18	5.83	0.65	2.12	0.30	0.07	0.06
C-348623	3816	Mercer	7.82	2.32	0.51	1.01	1.35	1.96	0.53	1.33	0.16
C-348650	3816	Mercer	8.16	2.36	0.45	0.91	1.40	2.05	0.50	0.07	0.13
C-348762	3816	Mercer	9.96	3.32	0.88	1.25	1.59	2.00	0.47	0.05	0.12
C-348916	1288	Montgomery	6.50	1.74	0.41	1.29	0.88	1.67	0.38	0.96	0.22
C-348834	1288	Montgomery	6.54	1.82	0.36	1.05	0.89	1.64	0.42	0.07	0.18
C-348485	1288	Montgomery	10.62	3.92	0.80	0.69	0.84	1.65	0.50	0.05	0.05
C-348912	7176	Morgan	6.50	1.97	0.38	0.77	0.86	1.89	0.42	1.04	0.10
C-348830	7176	Morgan	6.95	2.13	0.38	0.56	0.93	2.07	0.48	0.05	0.09
C-348481	7176	Morgan	9.77	4.15	0.78	0.50	0.65	1.94	0.37	0.05	0.04
C-348915	9480	Morgan	8.84	2.86	0.58	0.63	1.00	2.31	0.50	1.25	0.11
C-348833	9480	Morgan	8.92	2.97	0.60	0.57	0.94	2.21	0.52	0.05	0.09
C-348484	9480	Morgan	10.35	3.92	0.80	0.80	1.24	2.27	0.57	0.02	0.13
C-348618	3752	Peoria	8.67	3.02	0.75	0.80	0.82	1.93	0.53	1.33	0.24
C-348645	3752	Peoria	9.33	3.22	0.66	0.67	0.89	2.05	0.50	0.10	0.20
C-348757	3752	Peoria	8.10	2.99	4.89	6.98	0.82	2.37	0.33	0.07	0.08
C-348612	10248	Pike	7.16	2.15	0.50	1.37	1.17	2.25	0.50	1.25	0.41
C-348639	10248	Pike	6.50	1.93	0.38	0.97	1.06	2.04	0.38	0.07	0.32
C-348751	10248	Pike	9.90	3.79	0.73	0.81	1.24	2.24	0.55	0.02	0.13
C-348392	13044	Pope	6.40	1.94	0.35	0.85	0.74	1.65	0.42	1.04	0.11
C-348802	13044	Pope	4.00	1.10	0.33	3.51	0.38	0.84	0.28	0.27	0.15
C-348563	13044	Pope	8.92	3.37	0.78	0.60	1.13	1.92	0.60	0.05	0.06
C-348388	2804	Randolph	6.80	1.62	0.32	0.48	1.12	2.04	0.47	1.17	0.06
C-348798	2804	Randolph	6.95	1.64	0.32	0.42	1.08	1.92	0.53	0.05	0.04
C-348559	2804	Randolph	10.47	3.32	1.09	1.19	1.42	2.07	0.58	0.07	0.10
C-348389	8200	Randolph	7.39	1.84	0.41	1.25	1.20	2.17	0.45	1.12	0.45
C-348799	8200	Randolph	7.46	1.80	0.40	1.20	1.17	2.00	0.52	0.07	0.36
C-348560	8200	Randolph	10.14	3.95	0.99	0.80	1.16	2.07	0.57	0.05	0.17
C-348402	1516	Richland	6.91	2.60	0.41	0.59	0.89	1.57	0.43	1.08	0.25
C-348812	1516	Richland	7.22	2.59	0.40	0.55	0.89	1.48	0.52	0.05	0.15
C-348573	1516	Richland	8.03	2.70	0.60	0.62	0.85	1.55	0.57	0.05	0.07
C-348394	9972	Saline	6.40	2.43	0.45	0.92	0.71	1.67	0.45	1.12	0.27
C-348804	9972	Saline	7.10	2.69	0.41	0.73	0.75	1.67	0.57	0.10	0.17
C-348565	9972	Saline	9.24	3.36	0.80	0.71	1.21	1.95	0.68	0.05	0.10
C-348610	11944	Sangamon	7.61	2.45	0.55	0.76	0.98	2.05	0.53	1.33	0.17
C-348637	11944	Sangamon	8.31	2.72	0.50	0.60	1.09	2.25	0.47	0.07	0.14
C-348749	11944	Sangamon	9.20	3.50	3.05	3.85	1.04	2.40	0.50	0.07	0.11
C-348616	2728	Schuyler	7.54	2.16	0.51	0.81	1.09	1.89	0.55	1.37	0.11
C-348643	2728	Schuyler	7.76	2.49	0.45	0.70	1.12	1.96	0.52	0.07	0.10
C-348755	2728	Schuyler	10.22	3.85	0.91	0.78	1.12	1.98	0.55	0.05	0.11
C-348909	4104	St. Clair	7.56	2.20	0.50	1.20	1.05	2.02	0.43	1.08	0.36
C-348827	4104	St. Clair	7.80	2.35	0.51	1.30	1.08	1.92	0.47	0.17	0.37
C-348478	4104	St. Clair	11.16	4.39	1.06	0.97	1.21	2.23	0.52	0.07	0.21
C-348621	4008	Stephenson	9.20	3.10	0.81	1.06	0.97	1.88	0.55	1.37	0.19
C-348648	4008	Stephenson	8.65	2.95	0.65	0.80	0.89	1.74	0.45	0.10	0.13

Continued on next page

Electronic Filing: Received, Clerk's Office 3/24/2022

Lab no.	Site ID	County	Al <sub>2</sub> O <sub>3</sub> (wt%)	Fe <sub>2</sub> O <sub>3</sub> (wt%)	MgO (wt%)	CaO (wt%)	NaO (wt%)	K <sub>2</sub> O (wt%)	TiO <sub>2</sub> (wt%)	SO <sub>3</sub> (wt%)	P <sub>2</sub> O <sub>5</sub> (wt%)
C-348760	4008	Stephenson	10.96	4.20	1.01	0.90	1.09	1.96	0.52	0.05	0.13
C-348793	5096	Stephenson	9.20	3.17	1.09	1.29	0.93	1.75	0.50	1.25	0.18
C-348680	5096	Stephenson	9.46	3.25	1.11	1.27	0.93	1.95	0.50	0.10	0.16
C-348900	5096	Stephenson	7.73	3.19	4.23	5.51	0.90	1.78	0.35	0.07	0.11
C-348603	9192	Stephenson	8.73	2.83	1.16	1.52	0.94	2.06	0.52	1.29	0.30
C-348630	9192	Stephenson	8.93	2.86	0.99	1.30	0.97	2.08	0.45	0.15	0.27
C-348742	9192	Stephenson	17.08	8.55	1.43	0.70	0.24	1.53	0.57	0.05	0.13
C-348617	10920	Tazewell	5.57	2.32	2.06	3.65	0.71	1.57	0.23	0.58	0.14
C-348644	10920	Tazewell	5.93	2.63	2.25	4.16	0.77	1.66	0.22	0.15	0.13
C-348756	10920	Tazewell	6.12	2.10	1.08	1.61	0.81	1.63	0.27	0.05	0.08
C-348401	9204	Wayne	5.78	1.77	0.30	0.57	0.77	1.34	0.40	1.00	0.21
C-348811	9204	Wayne	5.48	1.60	0.32	0.62	0.70	1.21	0.43	0.12	0.25
C-348572	9204	Wayne	8.24	2.82	0.53	0.38	0.86	1.48	0.55	0.10	0.05
C-348400	12020	White	8.76	3.43	0.55	1.65	1.20	2.43	0.52	1.29	0.38
C-348810	12020	White	7.31	2.55	0.43	0.97	0.97	1.83	0.48	0.07	0.24
C-348571	12020	White	9.56	3.62	4.18	7.51	0.93	2.29	0.53	0.12	0.13
C-348398	5356	White	9.67	3.98	0.71	0.46	0.77	2.24	0.50	1.25	0.24
C-348808	5356	White	9.92	4.00	0.70	0.46	0.73	2.13	0.57	0.07	0.17
C-348569	5356	White	9.31	3.49	0.70	0.36	0.80	2.01	0.62	0.05	0.08
C-348771	936	Whiteside	5.80	2.83	2.29	4.18	0.78	1.30	0.28	0.71	0.18
C-348659	936	Whiteside	7.40	3.76	2.14	3.93	0.97	1.51	0.35	0.12	0.20
C-348878	936	Whiteside	7.05	2.77	1.38	2.52	1.00	1.49	0.35	0.22	0.14
C-348627	7080	Whiteside	9.07	3.92	1.08	1.25	0.84	1.87	0.47	1.17	0.22
C-348654	7080	Whiteside	10.16	4.46	1.06	1.19	0.90	2.01	0.45	0.10	0.22
C-348766	7080	Whiteside	8.97	4.13	0.96	1.09	1.01	1.88	0.40	0.02	0.13
C-348783	12712	Will	7.59	3.12	3.98	5.53	0.73	1.55	0.38	0.96	0.16
C-348671	12712	Will	7.84	3.13	3.60	4.94	0.74	1.77	0.40	0.12	0.17
C-348890	12712	Will	5.61	2.70	9.37	12.91	0.62	1.37	0.22	0.12	0.10
C-348395	5876	Williamson	9.63	3.39	0.83	1.78	0.89	1.81	0.48	1.21	0.10
C-348805	5876	Williamson	9.82	3.43	0.76	1.22	0.85	1.86	0.58	0.10	0.12
C-348566	5876	Williamson	9.54	3.40	0.71	0.46	0.94	2.01	0.70	0.07	0.08
C-348390	6900	Williamson	7.50	2.36	0.43	0.76	0.74	1.84	0.48	1.21	0.11
C-348800	6900	Williamson	7.31	2.16	0.40	0.81	0.71	1.71	0.52	0.07	0.08
C-348561	6900	Williamson	10.90	4.23	0.99	0.36	1.01	2.16	0.68	0.07	0.11

Continued on next page

Electronic Filing: Received, Clerk's Office 3/24/2022

Lab no.	Site ID	County	MnO (wt%)	Tot. C (%)	Inorg. C (%)	Org. C (%)	Ag (mg/kg)	As (mg/kg)	Ba (mg/kg)	Be (mg/kg)	Bi (mg/kg)
C-348582	9896	Adams	0.16				<1	10.6	685	1.5	0.17
C-348589	9896	Adams	0.19	1.24	ND	1.24	<1	9.6	613	1.2	0.18
C-348596	9896	Adams	0.16	1.43	ND	1.43		8.1	619	1.0	0.17
C-348613	12200	Adams	0.09				<1	6.4	590	1.1	0.33
C-348640	12200	Adams	0.11	2.11	ND	2.11	<1	6.3	638	1.2	0.21
C-348752	12200	Adams	0.14	0.15	ND	0.15		10.4	718	1.8	0.24
C-348387	13128	Alexander	0.05				<1	7.8	731	1.2	0.16
C-348797	13128	Alexander	0.05	2.30	ND	2.30	<1	6.4	784	1.4	0.17
C-348558	13128	Alexander	0.09	0.81	0.10	0.70		9.2	687	2.2	0.38
C-348407	11252	Bond	0.13				<1	9.1	534	1.1	0.26
C-348817	11252	Bond	0.13	2.08	ND	2.08	<1	8.7	534	1.2	0.18
C-348578	11252	Bond	0.08	0.11	ND	0.11		4.9	533	1.7	0.16
C-348790	6200	Boone	0.11				<1	5.1	568	1.2	0.17
C-348677	6200	Boone	0.11	2.54	0.20	2.30	<1	8.0	586	1.1	0.16
C-348897	6200	Boone	0.08	0.83	0.40	0.40		6.6	372	1.1	0.13
C-348772	6056	Bureau	0.06				<1	5.0	440	1.0	0.17
C-348660	6056	Bureau	0.07	5.69	1.90	3.80	<1	6.1	470	1.0	0.13
C-348879	6056	Bureau	0.05	2.49	2.30	0.20		5.3	330	0.7	0.07
C-348913	3080	Calhoun	0.11				<1	4.1	607	0.9	0.20
C-348831	3080	Calhoun	0.11	1.19	ND	1.19	<1	4.5	658	1.0	0.10
C-348482	3080	Calhoun	0.09	0.11	ND	0.11		9.7	597	1.5	0.26
C-348611	7848	Cass	0.10				<1	8.3	571	1.2	0.23
C-348638	7848	Cass	0.11	2.52	ND	2.52	<1	7.9	602	1.3	0.21
C-348750	7848	Cass	0.12	1.98	2.00	ND		9.1	517	1.3	0.18
C-348583	2472	Champaign	0.09				<1	11.8	497	1.9	0.17
C-348590	2472	Champaign	0.04	2.93	ND	2.93	<1	6.6	493	1.5	0.24
C-348597	2472	Champaign	0.04	3.14	ND	3.14		6.4	445	1.4	0.22
C-348604	7592	Champaign	0.10				<1	8.2	525	1.3	0.17
C-348631	7592	Champaign	0.11	3.08	ND	3.08	<1	8.0	517	1.3	0.22
C-348743	7592	Champaign	0.07	2.16	2.10	0.10		7.0	376	1.2	0.16
C-348605	9640	Champaign	0.07				<1	5.4	501	1.3	0.16
C-348632	9640	Champaign	0.06	2.17	ND	2.17	<1	5.8	488	1.2	0.20
C-348744	9640	Champaign	0.09	0.27	ND	0.27		9.4	471	2.1	0.22
C-348918	2036	Christian	0.06				<1	6.8	565	1.3	0.24
C-348836	2036	Christian	0.06	3.03	0.10	2.90	<1	7.6	553	1.3	0.20
C-348487	2036	Christian	0.09	0.23	ND	0.23		10.9	571	1.5	0.21
C-348919	6132	Christian	0.06				<1	9.3	658	2.9	0.12
C-348837	6132	Christian	0.06	11.50	ND	11.50	<1	11.9	658	4.4	0.13
C-348488	6132	Christian	0.04	0.25	ND	0.25		5.6	552	1.5	0.18
C-348920	10228	Christian	0.10				<1	6.6	567	1.0	0.23
C-348838	10228	Christian	0.09	1.64	0.10	1.50	<1	7.6	570	1.1	0.16
C-348489	10228	Christian	0.11	0.18	ND	0.18		8.3	625	1.5	0.24
C-348908	492	Clark	0.06				<1	6.8	522	1.1	0.19
C-348826	492	Clark	0.06	0.94	ND	0.94	<1	7.1	512	1.2	0.16
C-348477	492	Clark	0.05	0.16	ND	0.16		9.8	568	1.5	0.22
C-348923	4588	Clark	0.07				<1	5.3	515	1.1	0.19
C-348841	4588	Clark	0.06	1.32	ND	1.32	<1	5.8	500	1.0	0.16
C-348492	4588	Clark	0.03	0.25	ND	0.25		10.8	568	1.8	0.19
C-348922	11500	Clark	0.10				<1	8.7	479	1.1	0.21
C-348840	11500	Clark	0.10	1.40	ND	1.40	<1	7.4	475	1.0	0.15
C-348491	11500	Clark	0.03	0.07	ND	0.07		5.4	515	1.2	0.15
C-348403	1012	Clay	0.05				<1	5.8	362	0.8	0.10
C-348813	1012	Clay	0.07	1.66	ND	1.66	<1	5.7	392	0.9	0.16
C-348574	1012	Clay	0.11	1.79	1.90	ND		6.2	385	1.2	0.13

Continued on next page

Electronic Filing: Received, Clerk's Office 3/24/2022

Lab no.	Site ID	County	MnO (wt%)	Tot. C (%)	Inorg. C (%)	Org. C (%)	Ag (mg/kg)	As (mg/kg)	Ba (mg/kg)	Be (mg/kg)	Bi (mg/kg)
C-348904	10996	Clinton	0.09				<1	7.3	607	1.1	0.14
C-348822	10996	Clinton	0.10	2.93	0.30	2.60	<1	7.8	626	1.2	0.29
C-348473	10996	Clinton	0.10	0.19	ND	0.19		12.6	806	1.4	0.24
C-348906	3060	Coles	0.12				<1	8.4	565	1.3	0.11
C-348824	3060	Coles	0.10	2.22	ND	2.22	<1	8.0	548	1.4	0.20
C-348475	3060	Coles	0.07	1.63	1.80	ND		7.7	420	1.5	0.21
C-348921	7156	Coles	0.04				<1	3.7	372	0.6	0.19
C-348839	7156	Coles	0.05	1.63	0.50	1.10	<1	3.7	377	0.7	0.09
C-348490	7156	Coles	0.02	1.08	0.60	0.50		3.4	358	0.7	0.11
C-348786	1448	Cook	0.05				<1	8.0	453	2.2	0.10
C-348673	1448	Cook	0.05	5.61	0.30	5.30	<1	8.2	444	2.1	0.28
C-348893	1448	Cook	0.06	3.39	2.40	1.00		9.7	391	<0.1	0.20
C-348784	5544	Cook	0.07				<1	11.0	441	1.3	0.12
C-348672	5544	Cook	0.07	1.53	ND	1.53	<1	16.5	450	1.6	0.16
C-348891	5544	Cook	0.07	2.79	2.10	0.70		15.7	377	1.7	0.24
C-348788	10296	Cook	0.08				<1	8.8	516	1.6	0.14
C-348675	10296	Cook	0.11	3.99	ND	3.99	<1	9.5	560	1.5	0.23
C-348895	10296	Cook	0.08	3.42	3.00	0.40		8.2	441	1.7	0.18
C-348404	8684	Crawford	0.15				<1	10.6	494	1.1	0.19
C-348814	8684	Crawford	0.15	1.62	ND	1.62	<1	8.9	517	1.0	0.16
C-348575	8684	Crawford	0.06	0.11	ND	0.11		5.8	468	1.0	0.14
C-348682	4776	Dewitt	0.11				<1	8.1	625	1.4	0.14
C-348655	4776	Dewitt	0.11	2.45	ND	2.45	<1	8.0	582	1.3	0.23
C-348767	4776	Dewitt	0.07	2.18	2.20	ND		5.8	405	1.5	0.14
C-348818	3496	Douglas	0.08				<1	7.4	533	1.3	0.23
C-348819	3496	Douglas	0.08	2.04	ND	2.04	<1	7.0	531	1.3	0.22
C-348579	3496	Douglas	0.03	0.13	ND	0.13		4.8	363	0.8	0.10
C-348905	11688	Douglas	0.12				<1	8.6	571	1.2	0.14
C-348823	11688	Douglas	0.12	2.69	ND	2.69	<1	7.8	573	1.3	0.22
C-348474	11688	Douglas	0.08	1.14	1.00	0.10		9.5	438	1.7	0.22
C-348907	6672	Edgar	0.13				<1	7.4	413	0.8	0.22
C-348825	6672	Edgar	0.14	9.33	ND	9.33	<1	5.9	472	0.9	0.14
C-348476	6672	Edgar	0.06	0.68	0.90	ND		8.1	441	1.5	0.23
C-348585	1704	Fulton	0.13				<1	10.1	603	1.5	0.19
C-348592	1704	Fulton	0.12	0.89	ND	0.89	<1	7.2	575	1.1	0.18
C-348599	1704	Fulton	0.12	1.05	ND	1.05		6.9	566	1.0	0.18
C-348914	5384	Greene	0.06				<1	5.5	488	1.0	0.22
C-348832	5384	Greene	0.06	1.93	ND	1.93	<1	5.3	452	1.0	0.13
C-348483	5384	Greene	0.08	0.10	ND	0.10		9.1	478	2.1	0.22
C-348775	6312	Grundy	0.10				<1	10.9	598	1.5	0.17
C-348663	6312	Grundy	0.10	3.57	ND	3.57	<1	13.1	591	1.5	0.24
C-348882	6312	Grundy	0.06	4.21	4.30	ND		5.9	336	0.7	0.09
C-348776	11432	Grundy	0.07				<1	7.0	551	1.4	0.23
C-348664	11432	Grundy	0.07	3.54	ND	3.54	<1	8.7	576	1.5	0.22
C-348883	11432	Grundy	0.11	0.56	ND	0.56		11.4	581	1.9	0.22
C-348397	7924	Hamilton	0.12				<1	8.6	492	1.0	0.22
C-348807	7924	Hamilton	0.15	2.40	ND	2.40	<1	8.1	569	1.3	0.17
C-348568	7924	Hamilton	0.05	0.17	ND	0.17		6.2	653	1.8	0.18
C-348615	8104	Hancock	0.06				<1	5.6	564	1.0	0.05
C-348642	8104	Hancock	0.08	3.05	ND	3.05	<1	6.3	556	1.1	0.21
C-348754	8104	Hancock	0.13	0.30	ND	0.30		6.6	402	1.5	0.21
C-348624	1256	Henderson	0.07				<1	2.3	340	0.6	0.17
C-348651	1256	Henderson	0.06	3.49	ND	3.49	<1	2.0	341	0.6	0.19
C-348763	1256	Henderson	0.03	0.10	ND	0.10		1.3	346	0.6	<0.04
C-348778	4520	Iroquois	0.05				<1	6.7	460	1.2	0.14
C-348666	4520	Iroquois	0.06	3.29	ND	3.29	<1	9.2	471	1.4	0.20
C-348885	4520	Iroquois	0.06	2.88	2.50	0.40		10.7	391	1.8	0.19
C-348781	9744	Iroquois	0.03				<1	4.4	478	1.3	0.20

Continued on next page



Electronic Filing: Received, Clerk's Office 3/24/2022

Lab no.	Site ID	County	MnO (wt%)	Tot. C (%)	Inorg. C (%)	Org. C (%)	Ag (mg/kg)	As (mg/kg)	Ba (mg/kg)	Be (mg/kg)	Bi (mg/kg)
C-348669	9744	Iroquois	0.03	2.79	ND	2.79	<1	5.2	471	1.3	0.19
C-348888	9744	Iroquois	0.05	1.39	1.10	0.30		7.7	435	1.3	0.16
C-348396	3828	Jefferson	0.10				<1	9.9	473	0.9	0.12
C-348806	3828	Jefferson	0.08	1.30	ND	1.30	<1	7.8	486	1.1	0.19
C-348567	3828	Jefferson	0.13	0.29	ND	0.29		6.7	587	1.6	0.20
C-348794	8168	Jo Daviess	0.11				<1	6.8	573	1.3	0.21
C-348681	8168	Jo Daviess	0.12	2.66	0.50	2.20	<1	7.1	587	1.3	0.20
C-348901	8168	Jo Daviess	0.11	1.06	0.50	0.60		8.9	538	2.3	0.19
C-348391	1780	Johnson	0.13				<1	8.6	523	1.0	0.23
C-348801	1780	Johnson	0.12	1.48	ND	1.48	<1	7.7	550	1.1	0.17
C-348562	1780	Johnson	0.04	0.11	ND	0.11		6.5	483	1.2	0.16
C-348785	10408	Kane	0.14				<1	7.4	576	1.3	0.23
C-348768	10408	Kane	0.14	2.37	ND	2.37	<1	8.5	608	1.5	0.20
C-348892	10408	Kane	0.09	3.62	3.50	0.10		12.5	379	1.4	0.18
C-348780	424	Kankakee	0.08				<1	5.7	430	1.2	0.16
C-348668	424	Kankakee	0.08	2.67	ND	2.67	<1	6.3	485	1.4	0.19
C-348887	424	Kankakee	0.10	1.45	0.20	1.30		10.0	469	1.5	0.22
C-348782	7952	Kankakee	0.02				<1	13.5	314	0.6	0.18
C-348670	7952	Kankakee	0.02	1.38	ND	1.38	<1	11.9	331	0.6	0.06
C-348889	7952	Kankakee	0.00	0.06	ND	0.06		1.4	318	0.4	<0.04
C-348777	8616	Kankakee	0.06				<1	7.0	433	1.5	0.12
C-348665	8616	Kankakee	0.05	3.65	0.70	3.00	<1	6.9	449	1.5	0.20
C-348884	8616	Kankakee	0.07	3.14	2.70	0.40		13.2	358	1.8	0.22
C-348626	5800	Knox	0.09				<1	6.5	568	1.1	0.17
C-348653	5800	Knox	0.11	2.01	ND	2.01	<1	8.1	621	1.2	0.20
C-348765	5800	Knox	0.13	0.12	ND	0.12		10.5	684	1.7	0.21
C-348620	10152	Knox	0.12				<1	21.6	336	2.5	0.15
C-348647	10152	Knox	0.11	4.66	2.20	2.50	<1	17.6	365	2.6	0.25
C-348759	10152	Knox	0.10	0.67	0.50	0.20		10.6	587	1.7	0.25
C-348774	3240	LaSalle	0.09				<1	8.4	538	1.8	0.09
C-348662	3240	LaSalle	0.09	2.81	0.30	2.50	<1	9.5	528	1.8	0.22
C-348881	3240	LaSalle	0.06	3.93	3.60	0.30		11.0	357	1.7	0.21
C-348773	7336	LaSalle	0.06				<1	4.7	514	1.2	0.11
C-348661	7336	LaSalle	0.06	2.79	0.80	2.00	<1	5.2	541	1.2	0.17
C-348880	7336	LaSalle	0.09	2.60	1.60	1.00		3.6	388	0.9	0.11
C-348791	5032	Lee	0.09				<1	5.5	607	1.2	0.20
C-348678	5032	Lee	0.09	2.24	0.40	1.80	<1	6.6	640	1.1	0.15
C-348898	5032	Lee	0.04	0.85	0.80	0.00		4.0	704	1.0	0.09
C-348792	9128	Lee	0.11				<1	6.3	612	1.4	0.16
C-348679	9128	Lee	0.12	3.36	ND	3.36	<1	6.7	613	1.3	0.20
C-348899	9128	Lee	0.06	2.16	2.30	ND		7.1	395	0.9	0.11
C-348586	680	Logan	0.12				<1	8.0	571	1.2	0.14
C-348593	680	Logan	0.12	2.50	ND	2.50	<1	7.7	562	1.2	0.22
C-348600	680	Logan	0.09	0.99	0.90	0.10		10.0	509	1.3	0.21
C-348609	8872	Logan	0.22				<1	6.5	650	1.2	0.18
C-348636	8872	Logan	0.19	1.32	ND	1.32	<1	7.2	651	1.2	0.16
C-348748	8872	Logan	0.09	0.21	ND	0.21		10.6	579	1.6	0.24
C-348911	264	Madison	0.08				<1	7.4	609	1.0	
C-348829	264	Madison	0.07	2.66	ND	2.66	<1	7.4	611	1.0	0.15
C-348480	264	Madison	0.05	0.13	ND	0.13		6.0	593	1.1	0.19
C-348406	4084	Marion	0.15				<1	9.8	429	0.8	0.18
C-348816	4084	Marion	0.14	2.58	ND	2.58	<1	10.5	504	1.4	0.20
C-348577	4084	Marion	0.06	0.12	ND	0.12		4.8	526	1.1	0.15
C-348405	5108	Marion	0.22				<1	8.4	590	1.0	0.19
C-348815	5108	Marion	0.21	1.23	ND	1.23	<1	5.9	606	1.3	0.16
C-348576	5108	Marion	0.03	0.14	ND	0.14		4.3	452	1.0	0.12
C-348619	1960	Marshall	0.10				<1	7.7	566	1.2	0.19

Continued on next page

Electronic Filing: Received, Clerk's Office 3/24/2022

Lab no.	Site ID	County	MnO (wt%)	Tot. C (%)	Inorg. C (%)	Org. C (%)	Ag (mg/kg)	As (mg/kg)	Ba (mg/kg)	Be (mg/kg)	Bi (mg/kg)
C-348646	1960	Marshall	0.11	2.56	ND	2.56	<1	6.8	581	1.3	0.25
C-348758	1960	Marshall	0.15	0.49	0.40	0.10		10.0	661	1.5	0.22
C-348606	6568	McLean	0.11				<1	8.6	510	1.4	0.23
C-348633	6568	McLean	0.10	2.09	ND	2.09	<1	7.9	484	1.3	0.19
C-348745	6568	McLean	0.07	0.40	ND	0.40		8.9	567	1.9	0.27
C-348587	6824	McDonough	0.10				<1	6.6	512	1.1	0.11
C-348594	6824	McDonough	0.11	2.25	ND	2.25	<1	7.6	563	1.3	0.20
C-348601	6824	McDonough	0.03	0.26	ND	0.26		5.5	474	1.3	0.18
C-348625	12968	McDonough	0.17				<1	6.8	656	1.0	0.16
C-348652	12968	McDonough	0.20	2.21	ND	2.21	<1	7.1	671	1.2	0.20
C-348764	12968	McDonough	0.10	0.17	ND	0.17		10.7	712	1.8	0.21
C-348789	2104	McHenry	0.08				<1	5.7	459	1.6	0.17
C-348676	2104	McHenry	0.09	2.79	ND	2.79	<1	6.6	464	1.4	0.18
C-348896	2104	McHenry	0.06	5.73	5.80	ND		4.8	322	1.3	0.13
C-348607	10664	McLean	0.14				<1	17.8	554	1.3	0.20
C-348634	10664	McLean	0.13	2.23	ND	2.23	<1	17.6	588	1.4	0.24
C-348746	10664	McLean	0.07	2.35	2.30	0.10		6.5	318	1.3	0.13
C-348623	3816	Mercer	0.09				<1	4.3	584	1.0	0.30
C-348650	3816	Mercer	0.11	1.61	ND	1.61	<1	4.1	602	1.0	0.17
C-348762	3816	Mercer	0.08	0.12	ND	0.12		6.5	647	1.4	0.16
C-348916	1288	Montgomery	0.05				<1	4.3	483	0.9	0.15
C-348834	1288	Montgomery	0.05	2.12	ND	2.12	<1	4.7	482	0.9	0.12
C-348485	1288	Montgomery	0.06	0.13	ND	0.13		6.5	499	1.5	0.20
C-348912	7176	Morgan	0.14				<1	5.2	560	0.9	0.07
C-348830	7176	Morgan	0.13	1.73	ND	1.73	<1	5.1	562	1.0	0.12
C-348481	7176	Morgan	0.08	0.13	ND	0.13		9.0	408	1.3	0.17
C-348915	9480	Morgan	0.12				<1	7.6	638	1.2	0.13
C-348833	9480	Morgan	0.12	1.11	ND	1.11	<1	8.0	609	1.2	0.19
C-348484	9480	Morgan	0.08	0.20	ND	0.20		6.3	578	1.4	0.17
C-348618	3752	Peoria	0.12				<1	8.5	552	1.2	0.20
C-348645	3752	Peoria	0.13	2.28	ND	2.28	<1	8.6	564	1.3	0.29
C-348757	3752	Peoria	0.06	2.62	2.60	0.00		6.1	453	1.3	0.12
C-348612	10248	Pike	0.13				<1	4.7	537	0.9	0.13
C-348639	10248	Pike	0.11	1.57	ND	1.57	<1	5.4	489	0.9	0.11
C-348751	10248	Pike	0.10	0.37	ND	0.37		7.2	545	1.3	0.17
C-348392	13044	Pope	0.13				<1	5.6	512	1.2	0.15
C-348802	13044	Pope	0.30	23.00	ND	23.00	<1	2.7	624	1.6	0.10
C-348563	13044	Pope	0.03	0.18	ND	0.18		8.1	468	1.3	0.17
C-348388	2804	Randolph	0.02				<1	3.1	508	0.7	0.20
C-348798	2804	Randolph	0.02	1.28	ND	1.28	<1	3.1	546	0.8	0.11
C-348559	2804	Randolph	0.07	0.12	ND	0.12		4.4	610	1.5	0.17
C-348389	8200	Randolph	0.15				<1	4.3	661	0.9	0.18
C-348799	8200	Randolph	0.16	1.69	0.10	1.60	<1	4.7	688	0.9	0.12
C-348560	8200	Randolph	0.09	0.10	ND	0.10		9.7	644	1.5	0.24
C-348402	1516	Richland	0.07				<1	7.0	436	1.0	0.33
C-348812	1516	Richland	0.09	0.98	ND	0.98	<1	6.9	435	1.1	0.18
C-348573	1516	Richland	0.06	0.09	ND	0.09		4.5	404	1.3	0.15
C-348394	9972	Saline	0.24				<1	7.8	544	1.0	0.21
C-348804	9972	Saline	0.28	2.26	ND	2.26	<1	8.3	596	1.3	0.16
C-348565	9972	Saline	0.04	0.11	ND	0.11		6.0	517	1.4	0.18
C-348610	11944	Sangamon	0.17				<1	7.5	561	1.1	0.22
C-348637	11944	Sangamon	0.18	1.12	ND	1.12	<1	8.3	643	1.2	0.17
C-348749	11944	Sangamon	0.07	1.43	1.30	0.10		8.1	516	1.4	0.18
C-348616	2728	Schuyler	0.11				<1	6.9	596	1.1	0.25
C-348643	2728	Schuyler	0.14	1.58	ND	1.58	<1	6.9	652	1.2	0.23
C-348755	2728	Schuyler	0.07	0.15	ND	0.15		8.8	663	1.4	0.20
C-348909	4104	St. Clair	0.09				<1	5.9	661	1.0	0.19
C-348827	4104	St. Clair	0.08	2.98	0.10	2.90	<1	5.3	648	1.0	0.15

Continued on next page



Electronic Filing: Received, Clerk's Office 3/24/2022

Lab no.	Site ID	County	MnO (wt%)	Tot. C (%)	Inorg. C (%)	Org. C (%)	Ag (mg/kg)	As (mg/kg)	Ba (mg/kg)	Be (mg/kg)	Bi (mg/kg)
C-348478	4104	St. Clair	0.09	0.18	ND	0.18		12.3	658	1.3	0.26
C-348621	4008	Stephenson	0.10				<1	6.5	556	1.2	0.16
C-348648	4008	Stephenson	0.12	2.17	ND	2.17	<1	6.8	536	1.3	0.22
C-348760	4008	Stephenson	0.07	0.31	ND	0.31		9.4	609	1.6	0.22
C-348793	5096	Stephenson	0.15				<1	8.8	647	1.3	0.16
C-348680	5096	Stephenson	0.15	2.40	0.10	2.30	<1	8.8	651	1.4	0.20
C-348900	5096	Stephenson	0.08	2.25	2.20	0.00		7.0	479	1.0	0.15
C-348603	9192	Stephenson	0.14				<1	6.8	631	1.2	0.19
C-348630	9192	Stephenson	0.14	3.80	0.10	3.70	<1	6.6	631	1.2	0.18
C-348742	9192	Stephenson	0.18	0.44	ND	0.44		17.0	563	2.9	0.32
C-348617	10920	Tazewell	0.05				<1	4.4	317	0.8	0.23
C-348644	10920	Tazewell	0.06	3.55	1.30	2.30	<1	6.0	329	0.9	0.17
C-348756	10920	Tazewell	0.06	1.19	0.40	0.80		5.4	396	1.0	0.11
C-348401	9204	Wayne	0.09				<1	5.4	374	0.7	0.19
C-348811	9204	Wayne	0.00	4.19	ND	4.19	<1	5.8	394	0.8	0.13
C-348572	9204	Wayne	0.05	0.08	ND	0.08		5.0	548	1.2	0.15
C-348400	12020	White	0.13				<1	9.1	504	1.0	0.18
C-348810	12020	White	0.10	1.89	ND	1.89	<1	7.6	514	1.1	0.31
C-348571	12020	White	0.10	2.20	2.50	ND		8.0	462	1.4	0.18
C-348398	5356	White	0.07				<1	12.0	499	1.2	0.15
C-348808	5356	White	0.08	1.44	ND	1.44	<1	10.8	528	1.5	0.21
C-348569	5356	White	0.05	0.15	ND	0.15		6.7	465	1.2	0.16
C-348771	936	Whiteside	0.11				<1	6.5	360	0.7	0.25
C-348659	936	Whiteside	0.10	3.11	1.10	2.00	<1	8.1	446	1.1	0.14
C-348878	936	Whiteside	0.04	4.29	0.50	3.80		3.2	434	1.0	0.10
C-348627	7080	Whiteside	0.12				<1	5.1	503	1.3	0.15
C-348654	7080	Whiteside	0.15	2.22	ND	2.22	<1	5.5	542	1.4	0.20
C-348766	7080	Whiteside	0.33	0.13	ND	0.13		7.8	718	1.3	0.14
C-348783	12712	Will	0.11				<1	7.3	468	1.3	0.20
C-348671	12712	Will	0.12	3.93	1.70	2.20	<1	7.5	483	1.4	0.17
C-348890	12712	Will	0.08	5.77	5.40	0.40		7.0	288	0.8	0.10
C-348395	5876	Williamson	0.07				<1	9.4	462	1.1	0.19
C-348805	5876	Williamson	0.09	1.47	0.10	1.40	<1	7.2	547	1.4	0.23
C-348566	5876	Williamson	0.09	0.11	ND	0.11		5.6	491	1.3	0.17
C-348390	6900	Williamson	0.09				<1	6.7	559	0.9	0.20
C-348800	6900	Williamson	0.12	5.10	ND	5.10	<1	6.0	596	1.0	0.15
C-348561	6900	Williamson	0.06	0.29	ND	0.29		11.5	584	1.4	0.26

Continued on next page

Electronic Filing: Received, Clerk's Office 3/24/2022

Lab no.	Site ID	County	Cd (mg/kg)	Ce (mg/kg)	Co (mg/kg)	Cr (mg/kg)	Cs (mg/kg)	Cu (mg/kg)	Ga (mg/kg)	Hg (µg/g)	In (mg/kg)
C-348582	9896	Adams	0.5	77.0	14.6	45	<5	22.8	13.0	0.03	0.04
C-348589	9896	Adams	0.2	65.2	11.7	37	<5	13.3	8.6	0.02	0.02
C-348596	9896	Adams	0.2	65.2	10.7	32	<5	10.9	8.5	0.02	0.03
C-348613	12200	Adams	0.2	56.7	7.7	38	<5	15.0	10.1	0.02	0.03
C-348640	12200	Adams	0.2	61.9	9.1	42	<5	15.0	11.0	0.02	0.03
C-348752	12200	Adams	0.5	83.0	15.5	45	5	24.4	14.3	0.03	0.05
C-348387	13128	Alexander	0.4	49.5	6.3	31	<5	21.8	9.4	0.03	0.03
C-348797	13128	Alexander	0.5	54.1	7.4	32	<5	16.3	10.3	0.03	0.03
C-348558	13128	Alexander	0.3	60.0	12.5	65	8	31.8	18.3	0.04	0.07
C-348407	11252	Bond	0.1	58.7	11.1	40	<5	16.9	10.3	0.04	0.04
C-348817	11252	Bond	0.1	53.4	10.8	40	<5	15.7	10.6	0.04	0.03
C-348578	11252	Bond	0.1	74.6	10.3	33	<5	14.3	11.7	0.02	0.03
C-348790	6200	Boone	0.2	53.8	10.5	46	<5	16.8	9.4	0.03	0.03
C-348677	6200	Boone	0.2	51.8	9.9	46	<5	15.3	10.0	0.03	0.03
C-348897	6200	Boone	<0.1	40.5	7.5	27	<5	17.1	10.1	0.04	0.03
C-348772	6056	Bureau	2.3	39.8	8.7	30	<5	15.5	7.3	0.03	0.08
C-348660	6056	Bureau	2.8	40.3	9.0	31	<5	16.7	7.8	0.03	0.10
C-348879	6056	Bureau	0.4	25.5	7.1	14	<5	10.2	6.0	0.01	0.02
C-348913	3080	Calhoun	0.2	48.3	7.6	35	<5	12.4	7.9	0.03	0.02
C-348831	3080	Calhoun	0.2	54.6	8.5	29	<5	11.5	9.4	0.03	0.03
C-348482	3080	Calhoun	0.2	66.7	10.8	34	<5	30.7	11.9	0.02	0.04
C-348611	7848	Cass	0.3	57.7	7.7	45	<5	18.2	10.0	0.03	0.03
C-348638	7848	Cass	0.3	61.3	9.1	37	<5	18.0	10.5	0.03	0.04
C-348750	7848	Cass	0.4	56.8	12.0	35	<5	20.8	10.4	0.02	0.04
C-348583	2472	Champaign	0.4	65.7	15.7	47	5	23.7	14.5	0.03	0.05
C-348590	2472	Champaign	0.3	60.2	9.1	50	<5	19.3	12.9	0.03	0.04
C-348597	2472	Champaign	0.3	58.5	8.3	47	<5	17.5	12.4	0.03	0.05
C-348604	7592	Champaign	0.2	59.8	10.2	44	<5	18.7	10.8	0.03	0.04
C-348631	7592	Champaign	0.1	63.1	12.0	37	<5	16.5	11.4	0.03	0.03
C-348743	7592	Champaign	0.1	48.7	10.4	29	<5	16.0	9.5	0.01	0.03
C-348605	9640	Champaign	0.2	51.7	7.0	42	<5	16.0	10.4	0.02	0.04
C-348632	9640	Champaign	0.2	52.7	7.0	36	<5	15.3	10.4	0.02	0.04
C-348744	9640	Champaign	0.2	66.3	15.3	56	8	21.3	15.3	0.03	0.05
C-348918	2036	Christian	0.3	51.9	7.9	37	<5	20.1	10.0	0.03	0.03
C-348836	2036	Christian	0.3	53.7	7.4	47	<5	21.2	10.8	0.03	0.03
C-348487	2036	Christian	0.3	70.4	11.6	40	<5	22.8	11.9	0.03	0.05
C-348919	6132	Christian	0.6	51.7	12.3	59	<5	32.1	11.5	0.04	0.03
C-348837	6132	Christian	0.9	51.6	15.4	75	6	46.2	11.6	0.04	<0.02
C-348488	6132	Christian	0.2	57.8	7.3	38	<5	18.6	11.4	0.04	0.04
C-348920	10228	Christian	0.2	50.6	8.8	36	<5	17.0	7.5	0.02	0.02
C-348838	10228	Christian	0.2	55.3	8.6	32	<5	13.1	8.8	0.03	0.03
C-348489	10228	Christian	0.4	73.2	11.7	39	5	24.7	13.2	0.04	0.05
C-348908	492	Clark	0.2	52.5	6.4	29	<5	13.1	8.7	0.02	0.03
C-348826	492	Clark	0.2	51.5	6.1	33	<5	14.2	9.2	0.04	0.03
C-348477	492	Clark	0.1	59.1	9.2	38	<5	23.8	11.6	0.05	0.05
C-348923	4588	Clark	0.2	55.3	6.6	32	<5	14.5	9.2	0.02	0.03
C-348841	4588	Clark	0.2	54.5	6.4	28	<5	15.3	10.0	0.02	0.03
C-348492	4588	Clark	0.1	65.7	8.8	34	<5	21.6	12.0	0.04	0.04
C-348922	11500	Clark	0.1	52.2	8.8	33	<5	12.5	8.9	0.03	0.03
C-348840	11500	Clark	<0.1	56.7	7.8	32	<5	11.0	8.8	0.03	0.03
C-348491	11500	Clark	<0.1	51.3	5.4	25	<5	13.8	10.4	0.03	0.03
C-348403	1012	Clay	<0.1	43.8	7.0	29	<5	15.0	9.3	0.03	0.03
C-348813	1012	Clay	<0.1	45.2	8.9	25	<5	14.0	10.4	0.03	0.03
C-348574	1012	Clay	0.1	45.8	9.5	23	<5	13.4	10.7	0.01	0.03
C-348904	10996	Clinton	0.3	46.1	5.7	38	<5	21.4	7.8	0.04	0.02
C-348822	10996	Clinton	0.3	48.9	6.4	42	<5	22.7	8.4	0.04	0.02

Continued on next page

Electronic Filing: Received, Clerk's Office 3/24/2022

Lab no.	Site ID	County	Cd (mg/kg)	Ce (mg/kg)	Co (mg/kg)	Cr (mg/kg)	Cs (mg/kg)	Cu (mg/kg)	Ga (mg/kg)	Hg (µg/g)	In (mg/kg)
C-348473	10996	Clinton	0.3	63.9	10.4	44	<5	25.0	11.4	0.04	0.04
C-348906	3060	Coles	0.3	61.4	15.1	47	<5	18.7	11.8	0.03	0.04
C-348824	3060	Coles	0.2	57.7	11.8	42	<5	17.5	11.7	0.03	0.04
C-348475	3060	Coles	<0.1	47.5	10.4	40	6	19.1	11.0	0.01	0.05
C-348921	7156	Coles	0.1	24.1	4.0	26	<5	14.1	5.3	0.02	<0.02
C-348839	7156	Coles	0.1	28.1	5.2	24	<5	8.2	6.7	0.02	<0.02
C-348490	7156	Coles	0.1	30.7	5.0	16	<5	9.0	6.1	0.03	<0.02
C-348786	1448	Cook	1.0	39.6	10.4	67	5	52.9	12.2	0.17	0.05
C-348673	1448	Cook	0.8	51.3	11.6	59	6	44.9	13.2	0.13	0.05
C-348893	1448	Cook	0.2	51.0	15.5	49	6	31.9	15.7	0.03	0.05
C-348784	5544	Cook	0.3	46.4	13.3	43	<5	22.6	9.3	0.04	0.04
C-348672	5544	Cook	0.2	45.4	15.4	42	<5	22.4	11.5	0.03	0.04
C-348891	5544	Cook	0.2	51.7	19.7	51	6	35.5	14.3	0.03	0.05
C-348788	10296	Cook	0.5	57.4	11.7	49	5	24.5	11.7	0.05	0.04
C-348675	10296	Cook	0.3	61.9	14.5	52	5	23.2	12.5	0.04	0.04
C-348895	10296	Cook	0.2	50.0	14.5	45	6	29.4	14.2	0.03	0.04
C-348404	8684	Crawford	0.2	54.4	10.5	36	<5	16.9	8.3	0.04	0.03
C-348814	8684	Crawford	0.2	50.8	9.8	36	<5	15.9	8.6	0.04	0.03
C-348575	8684	Crawford	0.2	49.5	8.0	28	<5	12.6	9.7	0.02	0.03
C-348682	4776	Dewitt	0.3	60.5	11.6	43	<5	20.2	10.5	0.04	0.03
C-348655	4776	Dewitt	0.3	62.2	10.7	43	<5	21.0	10.7	0.04	0.03
C-348767	4776	Dewitt	0.1	46.3	11.2	29	5	14.3	10.6	0.02	0.04
C-348818	3496	Douglas	0.2	51.6	9.8	42	<5	19.0	10.7	0.25	0.03
C-348819	3496	Douglas	0.3	58.2	11.4	45	<5	18.5	12.6	0.04	0.04
C-348579	3496	Douglas	<0.1	31.5	4.7	18	<5	11.8	7.5	0.01	0.02
C-348905	11688	Douglas	0.3	61.1	12.0	42	<5	22.8	11.2	0.05	0.04
C-348823	11688	Douglas	0.3	56.1	11.4	46	<5	23.3	10.7	0.05	0.03
C-348474	11688	Douglas	0.2	57.2	12.0	38	6	20.6	12.4	0.02	0.05
C-348907	6672	Edgar	0.3	35.4	7.9	31	<5	23.1	6.0	0.15	<0.02
C-348825	6672	Edgar	0.3	44.0	10.1	36	<5	21.6	8.0	0.05	0.03
C-348476	6672	Edgar	0.1	46.5	8.8	29	5	17.8	11.0	0.02	0.04
C-348585	1704	Fulton	0.5	76.5	14.5	38	<5	26.4	13.5	0.03	0.05
C-348592	1704	Fulton	0.2	57.6	9.1	34	<5	11.6	9.0	0.13	0.03
C-348599	1704	Fulton	0.1	59.3	9.4	30	<5	10.6	9.2	0.17	0.03
C-348914	5384	Greene	0.2	52.6	9.4	33	<5	26.3	9.5	0.03	0.03
C-348832	5384	Greene	0.2	54.0	9.9	27	<5	26.6	10.6	0.03	0.03
C-348483	5384	Greene	0.1	60.3	13.3	47	7	22.5	15.0	0.03	0.05
C-348775	6312	Grundy	0.4	58.2	8.1	49	<5	19.0	10.9	0.06	0.04
C-348663	6312	Grundy	0.4	58.0	8.9	49	<5	17.6	11.4	0.06	0.04
C-348882	6312	Grundy	0.2	31.6	7.0	18	<5	12.1	7.8	0.02	0.03
C-348776	11432	Grundy	0.4	58.4	9.5	53	<5	25.6	11.0	0.04	0.04
C-348664	11432	Grundy	0.5	60.6	9.8	54	5	26.3	12.1	0.04	0.04
C-348883	11432	Grundy	0.5	63.1	17.5	51	6	26.9	16.1	0.04	0.05
C-348397	7924	Hamilton	0.2	60.6	14.2	39	<5	16.2	8.4	0.06	0.03
C-348807	7924	Hamilton	0.2	65.4	17.5	34	<5	16.4	9.1	0.06	0.03
C-348568	7924	Hamilton	<0.1	76.1	17.6	39	<5	19.3	12.9	<0.01	0.04
C-348615	8104	Hancock	0.2	54.2	6.2	38	<5	19.6	9.9	0.04	0.03
C-348642	8104	Hancock	0.3	54.8	7.5	36	<5	20.5	9.7	0.05	0.03
C-348754	8104	Hancock	<0.1	70.0	24.7	34	5	17.6	14.9	0.03	0.05
C-348624	1256	Henderson	0.3	22.2	4.5	16	<5	9.1	6.0	0.04	<0.02
C-348651	1256	Henderson	0.3	20.4	4.6	10	<5	6.9	6.2	0.03	<0.02
C-348763	1256	Henderson	<0.1	19.9	4.6	7	<5	5.1	5.2	0.01	<0.02
C-348778	4520	Iroquois	0.2	50.2	10.1	48	<5	17.1	10.4	0.04	0.04
C-348666	4520	Iroquois	0.2	51.5	11.9	46	5	18.2	11.2	0.04	0.04
C-348885	4520	Iroquois	0.2	49.7	15.7	53	6	24.4	14.9	0.02	0.05
C-348781	9744	Iroquois	0.3	47.2	5.6	38	<5	17.2	9.7	0.04	0.03
C-348669	9744	Iroquois	0.3	44.3	5.7	37	<5	20.6	10.6	0.04	0.04
C-348888	9744	Iroquois	0.2	49.4	11.3	38	<5	20.6	13.1	0.03	0.04

Continued on next page

## Electronic Filing: Received, Clerk's Office 3/24/2022

Lab no.	Site ID	County	Cd (mg/kg)	Ce (mg/kg)	Co (mg/kg)	Cr (mg/kg)	Cs (mg/kg)	Cu (mg/kg)	Ga (mg/kg)	Hg (µg/g)	In (mg/kg)
C-348396	3828	Jefferson	0.1	53.6	6.9	32	<5	13.3	7.3	0.02	0.03
C-348806	3828	Jefferson	<0.1	61.9	6.8	32	<5	11.2	8.3	0.02	0.03
C-348567	3828	Jefferson	0.1	72.2	10.2	38	<5	14.3	12.2	0.02	0.04
C-348794	8168	Jo Daviess	0.2	59.2	12.0	51	<5	16.7	10.2	0.04	0.03
C-348681	8168	Jo Daviess	0.3	62.1	12.1	46	<5	18.1	11.1	0.04	0.03
C-348901	8168	Jo Daviess	0.1	58.6	15.4	55	6	19.4	19.0	0.03	0.06
C-348391	1780	Johnson	0.1	67.7	15.3	40	<5	16.3	9.8	0.04	0.03
C-348801	1780	Johnson	0.1	70.2	14.8	39	<5	15.0	9.6	0.04	0.03
C-348562	1780	Johnson	<0.1	64.6	8.7	33	<5	18.1	11.8	0.01	0.03
C-348785	10408	Kane	0.4	58.9	12.8	48	<5	20.2	9.9	0.05	0.03
C-348768	10408	Kane	0.8	59.2	13.3	49	<5	19.7	10.2	0.06	0.03
C-348892	10408	Kane	0.3	43.2	14.9	41	<5	35.3	11.7	0.03	0.04
C-348780	424	Kankakee	0.3	63.3	9.1	43	<5	13.7	9.3	0.04	0.03
C-348668	424	Kankakee	0.3	54.4	10.7	40	<5	13.7	11.0	0.03	0.04
C-348887	424	Kankakee	0.2	51.2	11.0	44	<5	17.9	13.6	0.05	0.04
C-348782	7952	Kankakee	0.2	17.0	2.8	10	<5	5.1	4.4	0.02	<0.02
C-348670	7952	Kankakee	0.2	18.7	3.4	14	<5	7.1	5.4	0.02	<0.02
C-348889	7952	Kankakee	<0.1	11.9	1.6	3	<5	2.9	4.0	<0.01	<0.02
C-348777	8616	Kankakee	0.3	52.4	11.6	50	5	21.4	11.1	0.03	0.04
C-348665	8616	Kankakee	0.3	49.7	10.5	48	5	22.2	11.8	0.03	0.04
C-348884	8616	Kankakee	0.2	52.1	18.6	48	6	33.4	15.0	0.03	0.05
C-348626	5800	Knox	0.1	59.1	8.6	41	<5	16.1	10.7	0.02	0.03
C-348653	5800	Knox	0.2	58.7	9.7	45	<5	16.6	11.7	0.02	0.03
C-348765	5800	Knox	0.5	70.1	13.7	43	<5	26.1	12.4	0.04	0.04
C-348620	10152	Knox	0.3	55.2	16.7	62	6	29.1	15.8	0.07	0.05
C-348647	10152	Knox	0.3	60.0	17.5	64	7	26.5	18.1	0.06	0.06
C-348759	10152	Knox	0.2	70.5	13.4	45	5	23.3	13.4	0.03	0.05
C-348774	3240	LaSalle	0.4	67.2	16.2	62	6	21.1	13.5	0.03	0.05
C-348662	3240	LaSalle	0.3	60.4	15.3	61	6	21.2	13.0	0.03	0.04
C-348881	3240	LaSalle	0.3	49.9	19.5	52	6	32.3	15.6	0.03	0.05
C-348773	7336	LaSalle	0.5	50.2	7.3	44	<5	15.4	9.5	0.06	0.03
C-348661	7336	LaSalle	0.5	49.7	7.2	38	<5	15.7	9.2	0.06	0.03
C-348880	7336	LaSalle	0.3	37.9	7.5	29	<5	9.6	8.9	0.02	0.02
C-348791	5032	Lee	0.2	47.3	9.0	35	<5	15.4	9.1	0.02	0.03
C-348678	5032	Lee	0.2	48.1	9.5	40	<5	15.2	10.2	0.03	0.03
C-348898	5032	Lee	<0.1	31.3	7.1	16	<5	13.7	9.5	0.02	0.02
C-348792	9128	Lee	0.3	57.2	9.3	48	<5	24.8	10.3	0.04	0.03
C-348679	9128	Lee	0.3	55.3	9.4	48	<5	20.3	10.4	0.05	0.03
C-348899	9128	Lee	0.2	37.1	7.7	18	<5	14.4	8.8	0.02	0.03
C-348586	680	Logan	0.3	68.6	11.7	45	<5	18.5	12.4	0.03	0.04
C-348593	680	Logan	0.3	63.2	10.3	46	<5	16.6	10.8	0.03	0.04
C-348600	680	Logan	0.3	63.5	11.9	49	<5	22.9	11.7	0.02	0.04
C-348609	8872	Logan	0.4	62.3	13.3	40	<5	16.7	9.1	0.04	0.03
C-348636	8872	Logan	0.4	65.5	14.1	35	<5	15.5	10.2	0.03	0.03
C-348748	8872	Logan	0.1	74.9	13.4	44	5	27.3	12.8	0.03	0.05
C-348911	264	Madison	0.6	52.9	7.1	36	<5	17.2	8.4	0.04	0.03
C-348829	264	Madison	0.5	48.5	6.4	38	<5	166.0	8.1	0.04	0.03
C-348480	264	Madison	0.2	59.6	7.6	32	<5	17.4	10.6	0.03	0.04
C-348406	4084	Marion	0.4	44.2	6.4	34	<5	17.0	6.8	0.05	0.02
C-348816	4084	Marion	0.4	49.5	8.6	42	<5	14.9	9.1	0.05	0.03
C-348577	4084	Marion	0.1	51.8	7.3	29	<5	13.0	10.4	0.03	0.03
C-348405	5108	Marion	0.2	60.3	15.4	35	<5	11.4	7.7	0.05	0.03
C-348815	5108	Marion	0.2	63.6	17.4	36	<5	12.8	8.6	0.04	0.03
C-348576	5108	Marion	<0.1	54.3	5.9	26	<5	12.5	9.2	<0.01	0.03
C-348619	1960	Marshall	0.4	60.6	9.1	45	<5	16.8	12.0	0.03	0.04
C-348646	1960	Marshall	0.4	61.3	9.6	48	<5	15.7	11.9	0.03	0.04
C-348758	1960	Marshall	0.4	69.7	15.7	45	<5	25.9	12.6	0.03	0.04
C-348606	6568	McLean	0.3	67.1	13.5	49	<5	23.0	12.0	0.06	0.04

*Continued on next page*

Electronic Filing: Received, Clerk's Office 3/24/2022

Lab no.	Site ID	County	Cd (mg/kg)	Ce (mg/kg)	Co (mg/kg)	Cr (mg/kg)	Cs (mg/kg)	Cu (mg/kg)	Ga (mg/kg)	Hg (µg/g)	In (mg/kg)
C-348633	6568	McLean	0.2	62.5	12.4	40	<5	19.4	11.0	0.04	0.04
C-348745	6568	McLean	0.2	70.7	14.4	54	6	21.4	14.9	0.05	0.05
C-348587	6824	McDonough	0.2	60.9	9.6	42	<5	16.5	10.2	0.03	0.03
C-348594	6824	McDonough	0.2	65.2	10.7	45	<5	16.6	11.0	0.03	0.04
C-348601	6824	McDonough	<0.1	54.8	7.3	41	<5	17.1	11.7	0.04	0.04
C-348625	12968	McDonough	0.3	61.6	9.2	39	<5	13.5	8.5	0.04	0.03
C-348652	12968	McDonough	0.3	64.0	10.6	37	<5	12.7	10.1	0.03	0.03
C-348764	12968	McDonough	0.3	78.8	14.9	41	<5	24.9	12.7	0.04	0.05
C-348789	2104	McHenry	0.2	52.0	12.1	53	<5	18.4	11.4	0.03	0.04
C-348676	2104	McHenry	0.1	54.9	12.7	48	<5	18.0	12.3	0.03	0.04
C-348896	2104	McHenry	0.1	42.6	11.2	31	<5	18.8	12.4	0.02	0.04
C-348607	10664	McLean	0.2	65.4	13.3	65	<5	54.5	11.8	0.02	0.04
C-348634	10664	McLean	0.2	66.5	13.2	54	<5	49.7	12.7	0.02	0.04
C-348746	10664	McLean	0.2	32.5	8.5	28	<5	17.5	8.3	0.01	0.04
C-348623	3816	Mercer	0.2	57.0	7.8	34	<5	11.2	9.6	0.02	0.02
C-348650	3816	Mercer	0.2	53.0	7.5	34	<5	10.4	9.7	0.03	<0.02
C-348762	3816	Mercer	0.2	58.1	9.7	30	<5	16.9	10.9	0.03	0.03
C-348916	1288	Montgomery	0.1	41.8	5.7	27	<5	13.9	7.0	0.03	0.02
C-348834	1288	Montgomery	0.1	47.3	6.4	28	<5	11.9	8.2	0.03	0.02
C-348485	1288	Montgomery	<0.1	57.3	8.5	31	<5	17.2	12.2	0.03	0.04
C-348912	7176	Morgan	0.2	50.8	9.2	32	<5	17.4	8.1	0.04	0.02
C-348830	7176	Morgan	0.2	50.2	8.8	32	<5	81.2	8.1	0.04	0.02
C-348481	7176	Morgan	<0.1	44.4	7.9	32	<5	19.6	9.5	0.04	0.04
C-348915	9480	Morgan	0.2	59.6	12.5	41	<5	19.5	10.4	0.03	0.03
C-348833	9480	Morgan	0.2	62.9	13.6	41	<5	16.2	12.0	0.03	0.04
C-348484	9480	Morgan	0.2	61.3	9.6	34	<5	21.1	11.7	0.03	0.04
C-348618	3752	Peoria	0.4	60.4	12.4	43	<5	19.7	11.2	0.08	0.04
C-348645	3752	Peoria	0.4	65.8	12.9	46	<5	18.9	12.1	0.07	0.04
C-348757	3752	Peoria	0.1	43.0	9.7	22	<5	15.3	9.5	0.02	0.03
C-348612	10248	Pike	0.4	59.5	9.3	33	<5	17.4	9.4	0.05	0.03
C-348639	10248	Pike	0.4	54.4	8.6	26	<5	15.2	8.5	0.06	0.03
C-348751	10248	Pike	0.2	64.2	11.3	45	<5	20.6	11.9	0.03	0.04
C-348392	13044	Pope	0.3	64.3	10.7	32	<5	11.3	7.4	0.07	0.03
C-348802	13044	Pope	0.7	55.4	10.7	23	<5	11.4	4.2	0.10	<0.02
C-348563	13044	Pope	<0.1	69.7	7.5	37	<5	18.8	11.5	0.02	0.04
C-348388	2804	Randolph	<0.1	47.6	3.8	25	<5	8.6	7.3	0.03	0.02
C-348798	2804	Randolph	<0.1	52.6	4.6	27	<5	7.4	7.6	0.03	0.02
C-348559	2804	Randolph	0.2	62.6	9.5	33	<5	18.0	13.2	0.03	0.04
C-348389	8200	Randolph	0.3	58.9	9.0	28	<5	11.3	8.1	0.03	0.03
C-348799	8200	Randolph	0.2	60.6	9.5	29	<5	10.6	7.8	0.02	0.02
C-348560	8200	Randolph	0.1	66.9	12.0	37	<5	22.9	13.0	0.03	0.05
C-348402	1516	Richland	0.2	54.6	6.7	30	<5	14.0	8.1	0.04	0.03
C-348812	1516	Richland	0.1	49.5	6.3	26	<5	12.5	8.3	0.04	0.03
C-348573	1516	Richland	0.2	70.4	7.9	24	<5	12.4	10.5	0.01	0.03
C-348394	9972	Saline	0.3	64.5	13.2	34	<5	14.1	7.2	0.03	0.03
C-348804	9972	Saline	0.2	76.4	16.0	39	<5	14.1	7.9	0.03	0.03
C-348565	9972	Saline	<0.1	73.2	10.2	34	<5	19.5	11.4	0.01	0.04
C-348610	11944	Sangamon	0.2	61.0	12.0	40	<5	14.1	9.2	0.02	0.03
C-348637	11944	Sangamon	0.2	64.3	13.7	39	<5	14.5	9.8	0.03	0.03
C-348749	11944	Sangamon	0.2	63.3	10.4	34	<5	18.4	11.0	0.02	0.04
C-348616	2728	Schuyler	0.2	57.4	7.0	36	<5	11.8	8.9	0.02	0.03
C-348643	2728	Schuyler	0.2	63.1	9.8	38	<5	11.5	9.5	0.02	0.03
C-348755	2728	Schuyler	0.2	69.0	10.8	43	<5	18.7	12.4	0.03	0.04
C-348909	4104	St. Clair	0.3	51.3	6.7	33	<5	20.2	8.5	0.03	0.03
C-348827	4104	St. Clair	0.3	49.5	6.0	41	<5	21.0	8.6	0.03	0.02
C-348478	4104	St. Clair	0.3	64.6	12.5	42	<5	27.1	11.4	0.04	0.05
C-348621	4008	Stephenson	0.2	58.4	8.5	40	<5	18.3	10.7	0.03	0.03
C-348648	4008	Stephenson	0.2	63.2	10.0	45	<5	15.1	12.0	0.04	0.03

Continued on next page

Electronic Filing: Received, Clerk's Office 3/24/2022

Lab no.	Site ID	County	Cd (mg/kg)	Ce (mg/kg)	Co (mg/kg)	Cr (mg/kg)	Cs (mg/kg)	Cu (mg/kg)	Ga (mg/kg)	Hg (µg/g)	In (mg/kg)
C-348760	4008	Stephenson	0.2	67.5	10.4	48	<5	22.4	12.8	0.04	0.04
C-348793	5096	Stephenson	0.2	63.7	12.5	50	<5	17.9	10.7	0.02	0.04
C-348680	5096	Stephenson	0.2	62.1	13.3	49	<5	16.4	11.5	0.03	0.04
C-348900	5096	Stephenson	0.2	47.0	9.8	30	<5	19.6	11.2	0.03	0.03
C-348603	9192	Stephenson	0.2	57.8	11.7	49	<5	20.9	10.7	0.06	0.03
C-348630	9192	Stephenson	0.2	58.0	11.3	40	<5	18.8	10.5	0.07	0.03
C-348742	9192	Stephenson	0.2	87.5	13.5	68	7	37.9	21.5	0.11	0.08
C-348617	10920	Tazewell	0.7	30.1	6.2	21	<5	45.2	6.7	0.07	0.02
C-348644	10920	Tazewell	0.8	29.9	6.6	25	<5	26.8	7.0	0.07	0.02
C-348756	10920	Tazewell	0.4	37.2	8.3	25	<5	12.7	7.7	0.03	0.02
C-348401	9204	Wayne	<0.1	41.4	4.6	21	<5	12.8	5.4	0.04	<0.02
C-348811	9204	Wayne	0.1	52.2	5.5	22	<5	11.9	5.9	0.09	0.02
C-348572	9204	Wayne	<0.1	60.3	8.5	25	<5	12.5	10.0	0.01	0.03
C-348400	12020	White	0.4	50.4	8.9	38	<5	23.7	7.7	0.08	0.03
C-348810	12020	White	0.4	55.5	9.3	33	<5	19.0	8.1	0.10	0.03
C-348571	12020	White	0.3	56.0	11.2	31	<5	18.9	12.6	0.02	0.04
C-348398	5356	White	0.1	61.5	11.4	38	<5	50.7	11.0	0.03	0.04
C-348808	5356	White	0.1	67.8	12.0	40	<5	22.6	11.2	0.03	0.04
C-348569	5356	White	<0.1	55.6	8.8	33	<5	19.1	10.8	0.03	0.04
C-348771	936	Whiteside	0.3	31.6	6.6	26	<5	12.7	6.5	0.03	<0.02
C-348659	936	Whiteside	0.5	43.1	8.7	35	<5	16.5	9.0	0.04	0.03
C-348878	936	Whiteside	0.2	37.5	7.4	34	<5	11.8	8.8	0.03	0.02
C-348627	7080	Whiteside	0.4	59.1	11.0	45	<5	20.5	12.4	0.04	0.04
C-348654	7080	Whiteside	0.5	57.9	11.4	52	<5	22.8	12.7	0.03	0.04
C-348766	7080	Whiteside	0.6	50.3	13.3	35	<5	17.7	10.9	0.04	0.03
C-348783	12712	Will	0.3	47.4	9.8	42	<5	18.8	8.5	0.04	0.03
C-348671	12712	Will	0.3	47.3	10.9	42	<5	19.7	9.6	0.04	0.03
C-348890	12712	Will	0.2	28.6	6.9	26	<5	17.4	6.8	0.02	0.03
C-348395	5876	Williamson	0.1	55.4	8.7	40	<5	16.1	9.8	0.02	0.04
C-348805	5876	Williamson	0.3	68.7	12.4	41	<5	18.5	11.0	0.03	0.04
C-348566	5876	Williamson	<0.1	65.2	13.0	34	<5	18.2	11.4	0.02	0.04
C-348390	6900	Williamson	0.3	56.3	9.2	36	<5	13.4	8.4	0.07	0.03
C-348800	6900	Williamson	0.4	60.2	10.7	30	<5	12.3	8.1	0.07	0.03
C-348561	6900	Williamson	<0.1	66.1	10.8	41	<5	21.2	13.5	0.03	0.04

Continued on next page



Electronic Filing: Received, Clerk's Office 3/24/2022

Lab no.	Site ID	County	La (mg/kg)	Li (mg/kg)	Mo (mg/kg)	Nb (mg/kg)	Ni (mg/kg)	Pb (mg/kg)	Rb (mg/kg)	Sb (mg/kg)	Sc (mg/kg)
C-348582	9896	Adams	38.8	24	1.8	11.3	42.6	18.9	74.6	0.7	9.0
C-348589	9896	Adams	31.6	15	0.75	10.2	12.7	29.9	69.1	0.84	5.0
C-348596	9896	Adams	32.4	14	0.68	10.6	10.8	27.9	68.6	0.84	4.4
C-348613	12200	Adams	30.8	17	0.5	9.0	13.5	19.3	74.6	0.7	6.1
C-348640	12200	Adams	32.2	17	0.54	10.3	14.4	20.7	78.7	0.71	6.7
C-348752	12200	Adams	39.3	27	1.63	12.1	34.3	19.8	72.8	1.01	10.0
C-348387	13128	Alexander	27.2	22	0.6	8.5	16.1	24.8	62.6	0.7	4.9
C-348797	13128	Alexander	28.8	23	0.66	9.1	17.8	21.4	67.2	1.04	5.9
C-348558	13128	Alexander	32.4	46	1.47	12.7	32.4	30.2	104.0	1.24	13.0
C-348407	11252	Bond	31.0	23	1.2	10.8	14.7	25.0	63.9	0.9	5.8
C-348817	11252	Bond	28.3	23	1.11	9.8	14.7	21.1	67.1	0.89	6.0
C-348578	11252	Bond	36.2	30	0.95	9.3	30.3	16.5	74.5	0.48	7.7
C-348790	6200	Boone	27.6	20	0.8	9.0	17.0	27.2	66.2	0.7	6.3
C-348677	6200	Boone	26.1	20	0.77	8.3	16.6	25.3	67.3	0.57	6.1
C-348897	6200	Boone	26.3	20	0.79	5.6	26.2	11.0	52.1	0.52	7.0
C-348772	6056	Bureau	19.4	20	1.6	5.5	17.0	19.5	54.7	0.5	5.1
C-348660	6056	Bureau	19.6	22	1.63	5.8	17.7	20.9	57.3	0.56	5.3
C-348879	6056	Bureau	12.7	15	1.66	3.1	13.2	13.3	47.7	0.29	3.6
C-348913	3080	Calhoun	26.0	13	0.4	8.4	10.9	16.7	58.5	0.5	4.4
C-348831	3080	Calhoun	29.7	14	0.51	10.4	11.2	29.9	67.4	9.08	4.6
C-348482	3080	Calhoun	35.4	19	1.48	10.4	25.3	17.9	72.7	0.85	8.9
C-348611	7848	Cass	30.6	19	0.8	9.6	16.3	21.4	77.3	0.7	6.9
C-348638	7848	Cass	32.2	19	0.78	9.4	16.4	23.9	80.6	0.73	6.9
C-348750	7848	Cass	29.1	24	1.24	8.6	27.1	16.2	56.8	0.78	7.8
C-348583	2472	Champaign	33.2	34	1.9	10.8	33.1	23.1	101.0	0.9	10.2
C-348590	2472	Champaign	32.0	29	0.64	10.9	19.5	23.0	95.4	0.60	9.0
C-348597	2472	Champaign	31.6	28	0.61	10.3	17.6	21.9	92.8	0.60	7.9
C-348604	7592	Champaign	32.4	24	1.0	9.6	18.4	22.7	79.3	0.8	7.3
C-348631	7592	Champaign	33.2	23	0.99	9.6	17.4	23.9	81.6	0.77	7.1
C-348743	7592	Champaign	23.5	28	1.26	6.7	23.5	16.0	84.7	0.47	7.3
C-348605	9640	Champaign	28.1	22	0.8	8.9	15.5	22.5	83.6	0.6	6.9
C-348632	9640	Champaign	28.7	21	0.78	9.6	14.9	23.8	85.1	0.57	6.7
C-348744	9640	Champaign	33.2	49	1.34	9.4	39.4	20.2	94.5	0.59	11.3
C-348918	2036	Christian	27.2	22	0.9	8.7	16.1	29.3	69.0	0.6	6.7
C-348836	2036	Christian	28.5	24	1.13	10.0	16.5	32.2	72.7	0.73	7.0
C-348487	2036	Christian	36.5	24	1.07	10.4	28.0	19.4	77.0	0.71	9.3
C-348919	6132	Christian	26.3	21	12.3	10.3	29.2	27.2	76.9	0.9	8.5
C-348837	6132	Christian	25.7	23	22.30	10.3	40.5	20.3	74.8	0.82	10.9
C-348488	6132	Christian	30.1	23	0.47	9.6	18.5	16.6	64.8	0.58	8.3
C-348920	10228	Christian	24.7	16	0.7	8.4	10.9	21.4	56.8	0.7	4.8
C-348838	10228	Christian	27.3	14	0.98	9.8	10.9	23.7	65.0	0.78	5.1
C-348489	10228	Christian	36.0	27	0.79	10.6	31.4	20.3	77.0	0.68	9.9
C-348908	492	Clark	26.4	19	0.7	8.4	12.7	18.5	59.6	0.6	5.6
C-348826	492	Clark	26.3	18	0.70	8.9	13.7	18.9	60.2	0.56	6.2
C-348477	492	Clark	32.7	33	1.08	9.9	26.2	18.9	59.5	0.55	7.9
C-348923	4588	Clark	28.5	19	0.7	9.2	12.4	20.1	62.3	0.7	5.4
C-348841	4588	Clark	28.2	21	0.70	10.0	12.3	19.5	62.8	0.67	5.1
C-348492	4588	Clark	33.6	27	0.85	9.5	24.2	17.7	61.7	0.66	8.7
C-348922	11500	Clark	26.2	19	1.0	8.4	11.5	19.4	66.1	0.6	5.0
C-348840	11500	Clark	27.8	20	0.93	9.3	11.2	18.2	62.7	0.58	5.0
C-348491	11500	Clark	27.7	28	0.60	8.1	23.3	15.2	66.2	0.48	7.3
C-348403	1012	Clay	22.5	23	0.8	8.1	13.0	19.4	51.9	0.6	5.6
C-348813	1012	Clay	21.9	22	0.95	8.6	12.7	18.4	61.5	0.61	5.8
C-348574	1012	Clay	23.2	28	1.37	6.5	19.0	13.1	69.9	0.37	6.5
C-348904	10996	Clinton	23.9	17	0.9	7.9	13.4	36.5	55.4	0.7	4.9
C-348822	10996	Clinton	25.4	19	1.10	8.1	14.1	39.8	62.0	0.74	5.2

Continued on next page



Electronic Filing: Received, Clerk's Office 3/24/2022

Lab no.	Site ID	County	La (mg/kg)	Li (mg/kg)	Mo (mg/kg)	Nb (mg/kg)	Ni (mg/kg)	Pb (mg/kg)	Rb (mg/kg)	Sb (mg/kg)	Sc (mg/kg)
C-348473	10996	Clinton	33.5	28	0.72	10.5	28.9	18.2	60.6	0.77	7.1
C-348906	3060	Coles	30.8	24	0.9	10.9	16.8	28.2	84.5	0.8	6.8
C-348824	3060	Coles	29.6	23	0.87	10.4	17.8	25.0	80.5	0.76	7.6
C-348475	3060	Coles	23.7	47	0.76	8.1	30.1	16.0	85.1	0.40	7.7
C-348921	7156	Coles	12.1	10	0.4	3.7	7.7	16.5	46.8	0.2	2.7
C-348839	7156	Coles	14.0	12	0.56	4.2	8.9	21.2	53.7	0.31	2.9
C-348490	7156	Coles	15.3	13	0.43	4.0	10.7	20.1	53.5	0.34	3.5
C-348786	1448	Cook	22.1	38	3.1	9.2	31.4	103.0	84.3	2.2	8.9
C-348673	1448	Cook	25.7	36	2.56	7.9	29.2	75.9	93.0	1.87	9.6
C-348893	1448	Cook	25.7	53	7.24	7.8	38.4	17.1	98.6	0.83	11.1
C-348784	5544	Cook	22.3	28	3.8	7.1	21.7	31.3	68.0	0.9	6.3
C-348672	5544	Cook	22.5	26	3.85	11.3	21.2	30.4	84.5	0.93	7.8
C-348891	5544	Cook	25.3	42	11.40	9.0	38.6	23.9	47.1	1.30	10.3
C-348788	10296	Cook	29.3	37	1.5	9.4	21.4	31.5	86.4	0.8	8.4
C-348675	10296	Cook	30.5	37	1.36	9.5	23.3	29.5	91.0	0.72	8.7
C-348895	10296	Cook	24.6	60	3.22	7.8	34.2	15.9	123.0	0.63	10.1
C-348404	8684	Crawford	26.9	21	1.1	9.4	12.8	30.1	58.6	0.9	4.8
C-348814	8684	Crawford	24.6	19	1.00	8.9	13.9	25.0	64.3	0.77	5.5
C-348575	8684	Crawford	27.1	23	0.91	8.6	19.8	14.4	64.2	0.43	5.9
C-348682	4776	Dewitt	29.6	24	1.0	9.8	17.4	32.4	77.4	0.8	6.9
C-348655	4776	Dewitt	31.8	20	0.98	10.0	16.0	53.9	84.0	0.75	6.8
C-348767	4776	Dewitt	23.0	40	1.36	6.8	24.4	17.1	99.3	0.44	8.0
C-348818	3496	Douglas	26.0	25	0.8	8.9	17.1	25.5	78.3	0.7	7.0
C-348819	3496	Douglas	30.0	27	0.96	10.4	17.8	27.7	76.6	0.72	7.1
C-348579	3496	Douglas	16.7	14	0.44	4.2	13.2	12.3	57.1	0.35	4.7
C-348905	11688	Douglas	30.3	23	0.9	10.1	16.0	27.3	63.5	0.7	6.5
C-348823	11688	Douglas	28.5	25	0.83	9.3	17.4	26.7	76.1	0.69	6.9
C-348474	11688	Douglas	28.7	43	1.00	9.3	28.2	24.6	83.1	0.64	8.6
C-348907	6672	Edgar	16.9	15	1.1	5.9	11.4	20.2	52.2	0.5	4.0
C-348825	6672	Edgar	21.2	16	1.30	8.1	12.2	25.7	65.3	0.60	4.8
C-348476	6672	Edgar	24.3	30	0.77	7.1	25.2	16.3	73.2	0.50	7.4
C-348585	1704	Fulton	37.6	23	2.2	11.3	38.3	19.6	70.4	1.1	8.6
C-348592	1704	Fulton	29.4	15	0.80	10.8	10.0	26.7	70.0	0.79	5.2
C-348599	1704	Fulton	29.4	14	0.84	10.8	9.1	27.1	70.8	0.82	4.9
C-348914	5384	Greene	25.5	19	1.7	8.5	13.3	27.3	65.6	0.9	5.4
C-348832	5384	Greene	25.6	20	1.32	8.9	12.2	20.7	68.5	0.63	5.4
C-348483	5384	Greene	31.3	50	2.13	9.6	36.3	19.9	108.0	0.66	11.3
C-348775	6312	Grundy	31.4	25	1.1	10.4	17.9	38.7	87.0	0.7	7.6
C-348663	6312	Grundy	30.9	24	1.15	10.5	18.5	40.0	89.8	0.76	7.6
C-348882	6312	Grundy	15.4	18	2.21	4.6	13.4	11.3	50.1	0.44	4.8
C-348776	11432	Grundy	29.6	28	1.2	9.4	20.3	21.9	72.7	0.7	7.9
C-348664	11432	Grundy	31.0	30	1.26	9.6	22.2	23.2	86.2	0.70	8.2
C-348883	11432	Grundy	33.2	37	3.15	10.6	35.9	19.8	104.0	0.90	10.8
C-348397	7924	Hamilton	28.9	22	1.3	10.3	15.3	32.7	55.9	0.8	5.1
C-348807	7924	Hamilton	29.2	25	1.34	11.3	15.0	27.4	62.0	0.87	5.9
C-348568	7924	Hamilton	39.1	33	0.93	10.8	21.0	16.8	78.1	0.49	9.8
C-348615	8104	Hancock	30.2	19	0.7	9.6	13.1	21.3	72.7	0.7	6.0
C-348642	8104	Hancock	29.6	18	0.75	9.8	13.9	25.8	70.1	0.70	5.9
C-348754	8104	Hancock	27.3	35	1.48	10.3	23.1	17.7	62.6	0.76	9.2
C-348624	1256	Henderson	10.7	6	0.3	2.8	10.6	21.0	38.5	0.3	2.5
C-348651	1256	Henderson	10.4	5	0.28	2.5	10.3	20.4	39.2	0.27	2.2
C-348763	1256	Henderson	9.8	6	0.16	2.0	11.0	6.7	34.0	0.18	2.1
C-348778	4520	Iroquois	25.2	32	2.4	7.9	22.4	26.1	74.4	0.6	7.5
C-348666	4520	Iroquois	25.7	34	2.49	8.1	22.9	33.5	85.4	0.71	8.1
C-348885	4520	Iroquois	24.8	53	4.95	9.2	34.5	18.9	98.0	0.77	10.8
C-348781	9744	Iroquois	24.4	24	0.9	7.6	15.6	24.3	69.8	0.5	6.9
C-348669	9744	Iroquois	23.6	25	0.88	8.0	16.1	24.5	76.2	0.52	7.4
C-348888	9744	Iroquois	25.2	30	4.08	8.0	23.2	18.3	77.1	0.78	8.0

Continued on next page

Electronic Filing: Received, Clerk's Office 3/24/2022

Lab no.	Site ID	County	La (mg/kg)	Li (mg/kg)	Mo (mg/kg)	Nb (mg/kg)	Ni (mg/kg)	Pb (mg/kg)	Rb (mg/kg)	Sb (mg/kg)	Sc (mg/kg)
C-348396	3828	Jefferson	28.0	19	0.8	8.8	10.8	20.3	51.3	0.7	4.4
C-348806	3828	Jefferson	31.4	19	0.82	9.8	11.4	18.2	60.0	0.72	5.5
C-348567	3828	Jefferson	35.7	26	1.01	10.9	24.9	16.5	78.5	0.62	8.5
C-348794	8168	Jo Daviess	29.1	22	0.8	9.4	18.3	21.0	66.3	0.7	6.9
C-348681	8168	Jo Daviess	30.3	24	0.84	9.5	18.6	29.1	73.8	1.90	7.0
C-348901	8168	Jo Daviess	31.7	42	0.53	11.5	34.7	18.3	65.9	0.43	12.9
C-348391	1780	Johnson	31.8	25	1.2	11.4	17.7	22.7	63.4	0.8	5.8
C-348801	1780	Johnson	31.5	26	1.13	11.2	18.7	19.7	76.3	0.80	6.2
C-348562	1780	Johnson	33.0	23	1.00	10.6	16.7	15.0	68.3	0.56	7.6
C-348785	10408	Kane	28.2	22	2.0	9.9	18.0	28.9	72.6	1.0	6.5
C-348768	10408	Kane	29.0	24	1.89	10.3	18.0	30.1	75.0	0.88	7.0
C-348892	10408	Kane	22.2	35	6.61	6.7	34.6	18.0	77.9	1.00	9.4
C-348780	424	Kankakee	33.5	25	0.9	7.7	18.0	21.7	61.3	0.6	6.7
C-348668	424	Kankakee	28.5	25	0.93	8.2	18.8	21.1	69.1	0.61	7.2
C-348887	424	Kankakee	27.6	36	1.05	8.5	28.2	15.3	71.8	0.63	9.0
C-348782	7952	Kankakee	8.8	7	1.1	2.3	5.8	14.0	33.1	0.3	2.1
C-348670	7952	Kankakee	9.8	7	1.17	2.8	6.6	15.1	37.8	0.27	2.6
C-348889	7952	Kankakee	6.4	4	0.13	1.0	4.2	6.3	34.5	0.11	1.1
C-348777	8616	Kankakee	26.6	81	2.4	8.1	20.7	27.3	90.7	0.7	8.2
C-348665	8616	Kankakee	25.7	32	2.35	7.9	20.5	28.9	96.4	0.68	8.4
C-348884	8616	Kankakee	26.4	40	12.50	9.0	38.6	22.8	82.6	1.10	11.0
C-348626	5800	Knox	31.6	17	0.7	9.5	13.6	18.2	77.5	0.6	6.2
C-348653	5800	Knox	30.8	19	0.75	10.4	14.9	18.2	81.1	0.69	6.5
C-348765	5800	Knox	35.8	27	1.75	10.7	39.1	17.8	64.9	1.05	9.3
C-348620	10152	Knox	27.1	35	2.1	9.0	37.6	39.0	109.0	1.0	11.1
C-348647	10152	Knox	29.1	32	2.01	11.3	37.3	34.4	113.0	0.99	11.8
C-348759	10152	Knox	34.4	30	1.41	11.1	29.0	18.0	69.0	1.01	9.3
C-348774	3240	LaSalle	32.8	41	2.0	10.4	28.9	23.6	94.2	0.8	10.2
C-348662	3240	LaSalle	29.9	41	1.97	10.0	28.8	22.2	93.1	0.74	9.5
C-348881	3240	LaSalle	24.9	45	10.70	8.8	35.3	21.9	109.0	1.07	9.9
C-348773	7336	LaSalle	26.5	21	0.8	8.1	16.3	21.5	63.1	0.6	6.1
C-348661	7336	LaSalle	25.7	21	0.71	7.8	16.7	22.8	65.9	0.57	6.0
C-348880	7336	LaSalle	19.7	17	0.43	5.8	15.7	11.8	59.8	0.31	5.2
C-348791	5032	Lee	23.3	18	0.9	7.1	17.5	38.4	61.8	0.6	5.9
C-348678	5032	Lee	24.6	20	0.91	7.7	19.0	19.2	72.7	0.58	6.1
C-348898	5032	Lee	15.3	16	0.71	5.3	16.3	12.1	100.0	0.36	4.6
C-348792	9128	Lee	29.9	22	0.9	9.8	17.7	24.3	72.0	0.7	7.1
C-348679	9128	Lee	28.2	23	0.86	9.5	17.5	23.4	71.0	0.65	6.6
C-348899	9128	Lee	19.2	23	0.89	5.0	16.9	11.4	99.3	0.48	5.6
C-348586	680	Logan	35.5	20	1.0	12.1	16.2	28.0	93.7	0.8	6.7
C-348593	680	Logan	31.5	19	0.91	10.4	15.2	25.1	84.1	0.74	6.7
C-348600	680	Logan	32.5	24	1.25	9.8	28.7	19.4	68.7	0.87	8.4
C-348609	8872	Logan	34.3	17	1.1	9.6	19.9	23.8	71.4	0.7	5.7
C-348636	8872	Logan	36.6	17	1.21	10.3	18.1	22.6	79.4	0.70	5.8
C-348748	8872	Logan	38.3	29	1.68	10.5	30.1	19.6	85.1	0.90	9.5
C-348911	264	Madison	27.2	14	1.2	9.0	10.4	47.0	64.0	1.1	4.4
C-348829	264	Madison	25.1	15	1.03	8.2	10.6	43.5	59.8	0.95	4.6
C-348480	264	Madison	31.0	28	0.55	10.3	25.1	17.4	55.5	0.57	6.7
C-348406	4084	Marion	22.0	15	1.0	8.5	8.9	54.1	53.3	0.9	3.9
C-348816	4084	Marion	25.2	17	1.40	11.5	9.5	51.6	67.9	1.03	5.5
C-348577	4084	Marion	28.7	22	0.72	9.0	20.1	14.8	62.7	0.46	6.5
C-348405	5108	Marion	31.7	21	0.9	10.4	15.1	27.8	56.6	0.7	4.1
C-348815	5108	Marion	32.7	21	0.95	10.8	15.7	23.2	64.3	0.73	5.1
C-348576	5108	Marion	26.5	23	0.80	8.6	13.3	13.5	62.2	0.50	6.0
C-348619	1960	Marshall	33.0	22	0.9	10.5	15.5	24.4	90.1	0.8	6.9
C-348646	1960	Marshall	32.7	22	0.90	11.1	16.4	24.8	88.3	0.76	7.0
C-348758	1960	Marshall	37.3	31	1.82	10.2	39.7	19.2	65.5	1.15	8.8
C-348606	6568	McLean	33.1	25	1.4	9.4	22.0	32.0	81.4	0.8	7.7

Continued on next page

Electronic Filing: Received, Clerk's Office 3/24/2022

Lab no.	Site ID	County	La (mg/kg)	Li (mg/kg)	Mo (mg/kg)	Nb (mg/kg)	Ni (mg/kg)	Pb (mg/kg)	Rb (mg/kg)	Sb (mg/kg)	Sc (mg/kg)
C-348633	6568	McLean	31.0	22	1.28	8.4	20.2	29.3	76.9	0.71	7.5
C-348745	6568	McLean	35.2	45	1.94	10.6	30.9	20.9	96.5	0.61	10.6
C-348587	6824	McDonough	31.9	18	0.8	9.6	16.2	25.2	71.0	0.7	6.4
C-348594	6824	McDonough	33.6	20	0.82	10.6	17.7	25.6	75.6	0.79	7.0
C-348601	6824	McDonough	30.5	27	0.43	9.5	18.8	14.6	54.7	0.42	8.2
C-348625	12968	McDonough	32.6	15	0.9	9.0	14.7	25.3	69.3	0.6	5.0
C-348652	12968	McDonough	32.4	16	0.85	10.3	16.8	24.1	75.2	0.70	5.4
C-348764	12968	McDonough	37.4	27	1.28	10.7	37.4	17.6	65.3	0.95	9.8
C-348789	2104	McHenry	26.5	34	0.9	8.1	24.4	18.0	70.3	0.5	8.5
C-348676	2104	McHenry	27.1	35	0.94	8.2	23.3	19.1	84.2	0.50	8.5
C-348896	2104	McHenry	21.1	43	0.95	7.2	24.2	10.7	89.5	0.36	7.9
C-348607	10664	Mclean	32.8	25	1.2	9.9	20.5	25.1	85.5	1.0	7.4
C-348634	10664	Mclean	33.4	25	1.19	10.7	19.1	24.8	89.1	1.01	7.9
C-348746	10664	Mclean	15.8	27	1.65	5.6	20.8	15.9	51.9	0.50	6.6
C-348623	3816	Mercer	30.4	12	0.6	8.4	13.7	16.0	66.2	0.5	5.2
C-348650	3816	Mercer	28.7	12	0.63	9.0	14.3	17.1	67.0	0.48	5.4
C-348762	3816	Mercer	29.3	19	0.79	8.5	23.8	13.6	60.3	0.66	7.4
C-348916	1288	Montgomery	21.2	15	0.6	6.7	10.2	16.4	52.3	0.5	4.6
C-348834	1288	Montgomery	23.8	16	0.61	9.8	9.7	16.9	57.6	0.54	4.7
C-348485	1288	Montgomery	31.4	29	0.84	9.3	23.1	18.2	77.2	0.53	8.7
C-348912	7176	Morgan	27.2	15	0.7	8.3	14.6	19.5	61.7	0.6	4.9
C-348830	7176	Morgan	26.7	16	0.69	8.3	15.0	18.2	60.7	0.56	5.1
C-348481	7176	Morgan	22.4	30	1.19	6.5	26.4	17.2	57.4	0.54	6.2
C-348915	9480	Morgan	29.8	22	1.0	9.9	17.7	20.4	73.8	0.8	6.3
C-348833	9480	Morgan	31.6	23	1.09	11.2	17.7	21.6	79.6	0.89	6.7
C-348484	9480	Morgan	32.4	26	0.87	9.5	22.0	16.3	76.9	0.58	8.8
C-348618	3752	Peoria	31.9	21	1.3	9.8	18.3	45.6	77.2	0.9	6.9
C-348645	3752	Peoria	34.5	22	1.30	11.0	18.0	41.3	84.2	0.91	7.0
C-348757	3752	Peoria	21.5	32	1.25	6.0	22.7	12.7	68.2	0.48	6.6
C-348612	10248	Pike	32.3	13	1.2	8.9	15.0	24.8	69.5	0.6	5.0
C-348639	10248	Pike	29.9	11	1.03	7.9	14.1	22.4	64.9	0.50	4.5
C-348751	10248	Pike	30.4	22	0.98	9.6	21.2	16.4	71.0	0.59	8.5
C-348392	13044	Pope	33.6	20	0.9	9.1	13.4	31.7	47.0	0.6	4.1
C-348802	13044	Pope	31.4	11	0.62	5.9	13.9	19.7	29.5	0.46	2.5
C-348563	13044	Pope	34.3	22	1.07	11.1	17.8	15.6	68.1	0.52	8.5
C-348388	2804	Randolph	25.0	15	0.6	8.5	8.2	23.1	51.6	0.5	3.7
C-348798	2804	Randolph	27.0	16	0.58	8.9	9.3	21.6	55.9	1.00	4.2
C-348559	2804	Randolph	34.0	24	0.62	9.4	29.9	16.2	80.6	0.58	8.3
C-348389	8200	Randolph	31.1	16	0.6	9.7	14.1	19.8	60.9	0.7	4.3
C-348799	8200	Randolph	30.2	16	0.60	10.0	14.5	16.5	73.2	0.60	4.6
C-348560	8200	Randolph	34.2	21	1.29	10.5	24.4	18.8	72.6	1.04	8.5
C-348402	1516	Richland	28.1	19	0.7	9.4	11.2	23.7	51.8	0.8	4.9
C-348812	1516	Richland	24.8	18	0.82	9.5	10.5	20.2	55.2	0.67	5.5
C-348573	1516	Richland	39.8	28	0.95	9.2	29.3	15.9	67.2	0.48	6.5
C-348394	9972	Saline	30.6	20	1.1	9.1	15.2	26.2	55.8	0.9	4.0
C-348804	9972	Saline	33.8	24	1.19	10.3	17.7	24.8	59.9	1.00	4.9
C-348565	9972	Saline	37.3	26	0.97	10.8	20.2	15.4	66.9	0.53	8.1
C-348610	11944	Sangamon	30.6	16	0.9	10.1	14.1	24.2	70.7	0.8	5.7
C-348637	11944	Sangamon	31.8	17	0.97	9.2	15.1	25.8	72.7	0.77	6.1
C-348749	11944	Sangamon	32.4	27	0.91	9.4	24.0	16.4	65.0	0.63	8.5
C-348616	2728	Schuyler	30.0	16	0.6	9.8	11.9	20.1	70.6	0.7	5.3
C-348643	2728	Schuyler	32.8	16	0.67	11.1	12.7	23.4	72.9	0.82	5.4
C-348755	2728	Schuyler	35.1	29	1.06	11.1	29.3	16.5	72.3	0.67	8.9
C-348909	4104	St. Clair	26.4	17	0.9	8.9	13.1	26.8	69.8	0.7	5.1
C-348827	4104	St. Clair	25.5	16	0.81	8.4	13.6	26.6	68.6	0.69	5.4
C-348478	4104	St. Clair	35.3	27	0.90	10.5	31.3	19.6	62.4	0.90	7.3
C-348621	4008	Stephenson	31.0	23	0.9	9.2	18.4	20.4	74.5	0.6	6.9
C-348648	4008	Stephenson	32.7	20	0.94	10.3	16.9	20.8	80.4	0.69	6.7

Continued on next page

Electronic Filing: Received, Clerk's Office 3/24/2022

Lab no.	Site ID	County	La (mg/kg)	Li (mg/kg)	Mo (mg/kg)	Nb (mg/kg)	Ni (mg/kg)	Pb (mg/kg)	Rb (mg/kg)	Sb (mg/kg)	Sc (mg/kg)
C-348760	4008	Stephenson	36.5	29	1.14	10.4	26.3	16.9	67.5	0.92	9.1
C-348793	5096	Stephenson	30.2	23	0.9	10.2	18.3	23.3	70.1	0.7	7.2
C-348680	5096	Stephenson	30.3	23	0.89	10.1	17.7	22.7	78.8	0.71	7.0
C-348900	5096	Stephenson	24.3	21	0.90	7.5	22.8	13.8	56.7	0.72	6.9
C-348603	9192	Stephenson	29.3	20	1.0	9.3	18.2	26.3	74.9	0.7	6.6
C-348630	9192	Stephenson	30.1	20	0.94	9.2	18.2	28.3	75.0	0.63	6.4
C-348742	9192	Stephenson	40.8	63	2.00	11.2	60.7	23.7	77.2	1.38	16.4
C-348617	10920	Tazewell	15.5	14	1.1	3.7	14.7	49.2	48.9	0.9	4.0
C-348644	10920	Tazewell	15.3	15	1.24	4.0	14.7	52.4	49.4	0.79	4.2
C-348756	10920	Tazewell	18.9	16	0.84	5.7	16.1	17.9	53.5	0.56	4.8
C-348401	9204	Wayne	22.0	16	0.7	6.7	8.6	17.5	38.2	0.5	3.0
C-348811	9204	Wayne	26.4	12	0.87	8.0	8.3	17.1	46.0	0.56	3.7
C-348572	9204	Wayne	31.6	21	0.84	8.4	14.6	15.2	58.4	0.47	6.6
C-348400	12020	White	25.7	23	1.4	8.6	12.1	50.6	56.7	1.1	4.4
C-348810	12020	White	27.6	20	1.33	9.2	12.2	45.1	59.4	1.04	5.0
C-348571	12020	White	29.1	30	1.61	8.9	25.8	15.8	80.6	0.62	8.5
C-348398	5356	White	30.3	27	1.4	10.5	20.7	28.5	66.1	0.9	7.3
C-348808	5356	White	31.7	29	1.39	10.8	22.8	27.0	68.3	1.17	8.3
C-348569	5356	White	27.3	27	1.01	9.4	19.3	15.2	72.4	0.56	8.0
C-348771	936	Whiteside	16.4	12	0.5	4.6	13.1	14.1	39.8	0.3	4.5
C-348659	936	Whiteside	22.0	16	0.62	6.6	17.2	20.2	51.0	0.52	6.2
C-348878	936	Whiteside	19.4	15	0.37	6.5	12.8	11.1	47.1	0.29	5.5
C-348627	7080	Whiteside	30.9	22	0.4	8.5	20.5	22.6	76.8	0.4	7.5
C-348654	7080	Whiteside	30.3	27	0.45	8.9	22.8	22.4	76.9	0.45	8.5
C-348766	7080	Whiteside	25.6	21	0.74	7.2	31.0	13.6	49.7	0.52	7.5
C-348783	12712	Will	23.8	22	1.8	7.3	18.5	34.6	51.6	1.0	6.1
C-348671	12712	Will	24.4	23	1.83	7.8	18.6	35.8	62.8	0.79	6.6
C-348890	12712	Will	15.0	18	2.41	4.4	16.9	13.7	39.5	0.53	5.3
C-348395	5876	Williamson	28.3	30	0.8	8.8	20.1	17.0	58.2	0.6	6.3
C-348805	5876	Williamson	32.6	31	1.04	10.8	21.2	18.7	77.5	0.82	7.5
C-348566	5876	Williamson	30.9	28	1.03	10.3	20.9	15.9	75.2	0.64	7.8
C-348390	6900	Williamson	27.8	20	0.9	10.3	16.6	20.6	59.1	0.7	4.7
C-348800	6900	Williamson	28.4	20	0.79	9.9	17.6	20.9	58.2	0.71	5.0
C-348561	6900	Williamson	33.9	24	1.64	11.7	20.3	20.2	78.6	1.01	9.0

Continued on next page

Electronic Filing: Received, Clerk's Office 3/24/2022

Lab no.	Site ID	County	Se (mg/kg)	Sn (mg/kg)	Sr (mg/kg)	Te (mg/kg)	Th (mg/kg)	Tl (mg/kg)	U (mg/kg)	V (mg/kg)	W (mg/kg)
C-348582	9896	Adams	<0.2	1.5	137.0	<0.1	10.9	0.6	3.1	81	1.2
C-348589	9896	Adams	0.5	1.0	115.0	<0.1	9.6	0.4	3.4	62	1.1
C-348596	9896	Adams	0.5	1.0	114.0	<0.1	9.9	0.4	3.5	50	1.2
C-348613	12200	Adams	0.6	1.1	115.0	<0.1	9.7	0.5	3.1	62	1.0
C-348640	12200	Adams	0.6	1.4	119.0	<0.1	10.2	0.5	3.3	64	1.1
C-348752	12200	Adams	<0.2	1.6	142.0	<0.1	12.0	0.7	3.2	89	1.2
C-348387	13128	Alexander	0.4	1.4	171.0	<0.1	9.0	0.5	2.5	51	0.8
C-348797	13128	Alexander	0.5	1.5	169.0	<0.1	8.6	0.5	2.5	60	1.1
C-348558	13128	Alexander	0.3	2.1	122.0	<0.1	11.8	0.8	2.8	148	2.1
C-348407	11252	Bond	0.5	1.5	93.3	<0.1	11.3	0.6	3.4	61	0.9
C-348817	11252	Bond	0.5	2.3	93.4	<0.1	8.9	0.5	2.9	66	1.0
C-348578	11252	Bond	<0.2	1.4	118.0	<0.1	9.2	0.5	2.6	69	0.9
C-348790	6200	Boone	0.5	1.5	92.2	<0.1	8.4	0.5	2.4	61	1.0
C-348677	6200	Boone	0.3	1.2	94.0	<0.1	8.1	0.5	2.2	62	0.9
C-348897	6200	Boone	0.2	0.9	83.3	<0.1	5.8	0.4	1.4	70	0.5
C-348772	6056	Bureau	0.4	0.9	102.0	<0.1	5.5	0.5	1.9	40	0.6
C-348660	6056	Bureau	0.3	1.0	105.0	<0.1	6.2	0.5	2.1	40	0.6
C-348879	6056	Bureau	<0.2	0.6	92.3	<0.1	5.0	0.3	1.3	30	0.2
C-348913	3080	Calhoun	<0.2	1.9	125.0	<0.1	7.3	0.4	2.0	39	0.6
C-348831	3080	Calhoun	0.2	4.4	125.0	<0.1	8.0	0.4	2.3	42	0.8
C-348482	3080	Calhoun	<0.2	1.4	145.0	0.1	10.2	0.7	2.9	81	1.1
C-348611	7848	Cass	0.6	1.2	98.5	<0.1	10.1	0.6	3.2	65	1.2
C-348638	7848	Cass	0.7	1.1	98.5	<0.1	10.3	0.5	3.3	67	1.1
C-348750	7848	Cass	<0.2	1.2	117.0	<0.1	8.5	0.6	2.3	66	0.9
C-348583	2472	Champaign	<0.2	1.7	95.6	<0.1	10.8	0.7	3.0	96	1.3
C-348590	2472	Champaign	0.5	1.7	87.3	<0.1	10.4	0.6	3.5	75	1.3
C-348597	2472	Champaign	0.5	1.5	82.8	<0.1	10.2	0.6	3.5	67	1.3
C-348604	7592	Champaign	0.4	1.3	92.3	<0.1	9.9	0.6	3.1	67	1.2
C-348631	7592	Champaign	0.5	1.4	87.0	<0.1	10.3	0.6	3.3	64	1.1
C-348743	7592	Champaign	<0.2	1.2	95.2	<0.1	7.6	0.5	2.0	51	0.8
C-348605	9640	Champaign	0.3	1.4	87.4	<0.1	8.9	0.5	2.8	58	1.1
C-348632	9640	Champaign	0.4	1.4	83.2	<0.1	9.2	0.5	2.9	54	1.1
C-348744	9640	Champaign	<0.2	1.9	77.9	<0.1	10.2	0.7	2.8	80	1.2
C-348918	2036	Christian	0.5	1.6	109.0	<0.1	8.1	0.5	2.4	59	0.7
C-348836	2036	Christian	0.5	2.2	111.0	<0.1	8.6	0.5	2.7	61	0.9
C-348487	2036	Christian	<0.2	1.4	125.0	<0.1	10.4	0.6	3.1	75	1.1
C-348919	6132	Christian	1.7	1.2	108.0	<0.1	8.9	1.1	4.5	64	1.1
C-348837	6132	Christian	2.8	1.1	135.0	<0.1	9.0	1.4	6.3	89	1.2
C-348488	6132	Christian	<0.2	1.4	133.0	<0.1	9.2	0.5	2.6	63	0.9
C-348920	10228	Christian	0.4	0.9	106.0	<0.1	7.4	0.4	2.4	44	0.6
C-348838	10228	Christian	0.4	1.1	104.0	<0.1	8.4	0.4	2.8	50	0.8
C-348489	10228	Christian	<0.2	1.6	120.0	<0.1	10.9	0.7	2.9	79	1.0
C-348908	492	Clark	0.2	0.9	113.0	<0.1	7.8	0.4	2.4	48	0.6
C-348826	492	Clark	0.3	1.1	119.0	<0.1	7.8	0.5	2.4	55	0.7
C-348477	492	Clark	<0.2	1.3	123.0	<0.1	10.3	0.6	2.5	72	1.0
C-348923	4588	Clark	0.3	1.0	102.0	<0.1	8.4	0.4	2.6	45	0.6
C-348841	4588	Clark	0.4	1.2	105.0	<0.1	8.3	0.4	2.6	46	0.8
C-348492	4588	Clark	0.2	1.3	118.0	<0.1	9.4	0.5	3.0	70	0.9
C-348922	11500	Clark	0.4	0.8	87.1	<0.1	8.2	0.4	2.6	51	0.6
C-348840	11500	Clark	0.5	0.9	88.0	<0.1	9.6	0.4	2.5	53	0.7
C-348491	11500	Clark	<0.2	1.2	100.0	<0.1	7.9	0.5	2.1	55	0.7
C-348403	1012	Clay	0.4	1.1	72.2	<0.1	8.8	0.5	2.7	49	0.6
C-348813	1012	Clay	0.4	1.1	79.4	<0.1	7.3	0.5	2.3	54	0.8
C-348574	1012	Clay	<0.2	1.3	106.0	<0.1	6.6	0.4	1.8	49	0.9
C-348904	10996	Clinton	0.6	1.4	125.0	<0.1	7.2	0.4	2.7	44	0.7
C-348822	10996	Clinton	0.7	1.6	139.0	<0.1	7.6	0.4	3.0	54	0.8

Continued on next page



Electronic Filing: Received, Clerk's Office 3/24/2022

Lab no.	Site ID	County	Se (mg/kg)	Sn (mg/kg)	Sr (mg/kg)	Te (mg/kg)	Th (mg/kg)	Tl (mg/kg)	U (mg/kg)	V (mg/kg)	W (mg/kg)
C-348473	10996	Clinton	<0.2	1.4	140.0	<0.1	11.3	0.7	3.7	84	0.8
C-348906	3060	Coles	0.4	1.3	88.9	<0.1	9.7	0.6	2.9	57	1.0
C-348824	3060	Coles	0.4	1.3	92.4	<0.1	9.4	0.6	2.8	69	0.9
C-348475	3060	Coles	<0.2	1.5	85.6	<0.1	9.0	0.5	2.0	68	0.8
C-348921	7156	Coles	<0.2	0.8	90.0	<0.1	2.9	0.2	0.8	21	0.2
C-348839	7156	Coles	<0.2	0.9	90.1	<0.1	3.8	0.3	1.0	25	0.3
C-348490	7156	Coles	0.3	7.1	87.3	<0.1	4.1	0.3	1.5	28	0.4
C-348786	1448	Cook	0.9	6.0	106.0	<0.1	7.4	0.9	3.5	73	1.5
C-348673	1448	Cook	0.8	4.4	118.0	<0.1	8.2	0.9	4.1	69	1.1
C-348893	1448	Cook	0.4	1.8	97.8	<0.1	7.9	0.9	3.7	98	0.9
C-348784	5544	Cook	0.4	1.6	93.8	<0.1	6.8	0.7	3.0	56	0.7
C-348672	5544	Cook	0.3	1.5	93.6	<0.1	6.7	0.7	2.9	55	1.1
C-348891	5544	Cook	<0.2	1.7	80.9	<0.1	8.2	1.5	4.7	77	1.0
C-348788	10296	Cook	0.6	1.7	92.7	<0.1	9.0	0.7	3.5	71	1.1
C-348675	10296	Cook	0.6	1.7	95.7	<0.1	9.6	0.7	3.7	78	1.0
C-348895	10296	Cook	<0.2	1.6	106.0	<0.1	7.5	0.8	2.8	82	0.7
C-348404	8684	Crawford	0.4	1.7	86.3	<0.1	9.6	0.5	3.1	52	0.8
C-348814	8684	Crawford	0.5	1.4	90.1	<0.1	7.8	0.5	2.6	56	0.9
C-348575	8684	Crawford	<0.2	1.2	98.3	<0.1	7.8	0.4	2.1	52	0.8
C-348682	4776	Dewitt	0.2	2.0	107.0	<0.1	9.5	0.6	3.0	65	1.0
C-348655	4776	Dewitt	0.4	3.3	103.0	<0.1	10.1	0.6	3.0	60	1.3
C-348767	4776	Dewitt	<0.2	1.2	91.3	<0.1	7.0	0.4	1.8	57	0.8
C-348818	3496	Douglas	0.4	1.5	93.9	<0.1	7.9	0.5	2.5	61	0.8
C-348819	3496	Douglas	0.4	2.1	93.7	<0.1	9.2	0.6	2.9	64	1.0
C-348579	3496	Douglas	<0.2	0.7	96.9	<0.1	4.8	0.3	1.2	38	0.5
C-348905	11688	Douglas	0.4	1.5	94.5	<0.1	9.5	0.6	2.8	57	0.9
C-348823	11688	Douglas	0.5	1.5	96.9	<0.1	8.7	0.6	2.7	64	0.9
C-348474	11688	Douglas	<0.2	1.8	95.7	<0.1	10.5	0.7	2.4	63	0.8
C-348907	6672	Edgar	0.4	1.7	82.1	<0.1	5.2	0.3	1.6	35	0.5
C-348825	6672	Edgar	0.4	2.3	87.5	<0.1	6.4	0.4	2.0	45	0.8
C-348476	6672	Edgar	<0.2	1.3	91.4	<0.1	8.1	0.5	1.8	54	0.8
C-348585	1704	Fulton	<0.2	1.4	122.0	<0.1	11.5	0.7	3.0	85	1.2
C-348592	1704	Fulton	0.6	1.2	111.0	<0.1	9.6	0.5	3.3	60	1.1
C-348599	1704	Fulton	0.6	2.0	108.0	<0.1	10.0	0.5	3.4	57	1.2
C-348914	5384	Greene	0.3	1.0	100.0	<0.1	7.7	0.4	2.4	44	0.6
C-348832	5384	Greene	0.3	1.1	85.3	<0.1	8.1	0.5	2.4	48	0.7
C-348483	5384	Greene	<0.2	1.9	87.1	0.1	9.8	0.7	2.9	84	1.2
C-348775	6312	Grundy	0.6	2.5	99.9	<0.1	9.4	0.6	3.3	67	1.2
C-348663	6312	Grundy	0.5	1.6	94.5	<0.1	10.0	0.6	3.5	69	1.1
C-348882	6312	Grundy	<0.2	0.6	114.0	<0.1	4.4	0.4	1.5	34	0.3
C-348776	11432	Grundy	0.6	1.4	104.0	<0.1	8.9	0.6	3.5	71	1.1
C-348664	11432	Grundy	0.6	1.5	109.0	<0.1	9.8	0.7	3.8	75	1.1
C-348883	11432	Grundy	0.2	1.6	120.0	<0.1	9.8	0.7	3.0	101	1.0
C-348397	7924	Hamilton	0.4	1.4	73.5	<0.1	10.3	0.5	3.2	50	0.9
C-348807	7924	Hamilton	0.4	1.5	84.0	<0.1	10.0	0.5	3.1	54	1.3
C-348568	7924	Hamilton	0.4	1.5	131.0	<0.1	10.6	0.6	3.3	79	1.0
C-348615	8104	Hancock	0.4	2.1	110.0	<0.1	10.1	0.5	3.0	49	1.1
C-348642	8104	Hancock	0.4	1.8	108.0	<0.1	9.6	0.5	3.1	54	1.1
C-348754	8104	Hancock	0.3	1.6	65.3	<0.1	9.4	0.6	2.2	72	1.0
C-348624	1256	Henderson	<0.2	0.8	127.0	<0.1	2.5	0.2	0.7	24	0.3
C-348651	1256	Henderson	<0.2	1.0	114.0	<0.1	2.6	0.3	0.8	21	0.5
C-348763	1256	Henderson	<0.2	0.3	117.0	<0.1	2.2	0.2	0.6	23	0.1
C-348778	4520	Iroquois	0.5	2.3	81.0	<0.1	7.8	0.7	3.2	65	0.9
C-348666	4520	Iroquois	0.5	2.7	82.8	<0.1	8.3	0.7	3.5	61	0.9
C-348885	4520	Iroquois	<0.2	1.6	84.3	<0.1	8.1	0.9	3.6	82	0.9
C-348781	9744	Iroquois	0.5	1.4	101.0	<0.1	7.4	0.6	3.3	55	0.8
C-348669	9744	Iroquois	0.5	1.7	102.0	<0.1	7.6	0.6	3.5	55	0.9
C-348888	9744	Iroquois	<0.2	1.3	120.0	<0.1	7.3	0.7	2.4	61	0.7

Continued on next page



Electronic Filing: Received, Clerk's Office 3/24/2022

Lab no.	Site ID	County	Se (mg/kg)	Sn (mg/kg)	Sr (mg/kg)	Te (mg/kg)	Th (mg/kg)	Tl (mg/kg)	U (mg/kg)	V (mg/kg)	W (mg/kg)
C-348396	3828	Jefferson	0.5	0.9	87.1	<0.1	9.7	0.4	3.1	52	0.9
C-348806	3828	Jefferson	0.4	1.0	91.0	<0.1	9.5	0.4	3.1	55	1.4
C-348567	3828	Jefferson	0.2	1.3	101.0	<0.1	10.5	0.6	3.1	76	1.1
C-348794	8168	Jo Daviess	0.5	1.2	106.0	<0.1	9.0	0.5	2.8	67	1.0
C-348681	8168	Jo Daviess	0.3	1.4	113.0	<0.1	9.9	0.5	3.2	66	1.0
C-348901	8168	Jo Daviess	<0.2	2.0	82.9	<0.1	9.2	0.6	2.1	89	0.9
C-348391	1780	Johnson	0.4	1.2	76.7	<0.1	11.5	0.6	3.4	57	0.9
C-348801	1780	Johnson	0.5	1.3	79.4	<0.1	10.2	0.5	3.2	62	1.0
C-348562	1780	Johnson	<0.2	1.3	126.0	<0.1	9.4	0.5	2.6	66	1.0
C-348785	10408	Kane	0.4	1.6	106.0	<0.1	8.9	0.6	2.9	64	1.1
C-348768	10408	Kane	0.5	1.7	108.0	<0.1	9.1	0.6	3.0	67	1.2
C-348892	10408	Kane	<0.2	1.2	83.6	<0.1	6.2	1.2	3.4	71	0.7
C-348780	424	Kankakee	0.4	1.4	88.8	<0.1	9.8	0.5	1.8	60	0.9
C-348668	424	Kankakee	0.3	1.3	91.9	<0.1	9.0	0.6	2.0	62	0.9
C-348887	424	Kankakee	0.3	1.2	84.9	<0.1	7.7	0.6	1.7	86	0.8
C-348782	7952	Kankakee	0.2	1.1	84.3	<0.1	2.3	0.2	0.8	19	0.3
C-348670	7952	Kankakee	<0.2	1.7	90.3	<0.1	2.5	0.3	1.0	22	0.4
C-348889	7952	Kankakee	<0.2	0.2	85.0	<0.1	1.4	0.2	0.4	9	<0.1
C-348777	8616	Kankakee	0.6	2.0	80.0	<0.1	7.9	0.8	4.2	64	0.9
C-348665	8616	Kankakee	0.5	1.5	82.8	<0.1	8.2	0.8	4.2	64	0.9
C-348884	8616	Kankakee	0.2	1.6	79.5	<0.1	8.2	1.2	5.1	83	0.9
C-348626	5800	Knox	0.6	2.7	108.0	<0.1	9.7	0.5	3.2	63	1.1
C-348653	5800	Knox	0.6	1.2	113.0	<0.1	10.0	0.6	3.4	60	1.2
C-348765	5800	Knox	<0.2	1.4	137.0	<0.1	9.9	0.7	2.7	88	1.4
C-348620	10152	Knox	0.6	1.9	364.0	<0.1	9.9	0.6	2.1	72	1.2
C-348647	10152	Knox	0.5	2.3	343.0	<0.1	10.9	0.7	2.4	76	1.5
C-348759	10152	Knox	0.2	1.4	112.0	<0.1	10.8	0.7	2.9	92	1.1
C-348774	3240	LaSalle	0.5	1.7	93.8	<0.1	10.2	0.8	4.3	87	1.2
C-348662	3240	LaSalle	0.4	1.7	94.0	<0.1	9.9	0.8	4.3	85	1.2
C-348881	3240	LaSalle	0.2	1.7	80.5	<0.1	7.9	1.3	5.0	79	0.9
C-348773	7336	LaSalle	0.5	1.5	115.0	<0.1	7.6	0.5	2.3	55	0.8
C-348661	7336	LaSalle	0.4	1.5	116.0	<0.1	7.8	0.5	2.3	55	0.8
C-348880	7336	LaSalle	<0.2	0.8	100.0	<0.1	5.4	0.4	1.4	44	0.5
C-348791	5032	Lee	0.4	1.3	104.0	<0.1	6.7	0.5	2.0	53	0.7
C-348678	5032	Lee	0.2	1.8	108.0	<0.1	7.5	0.5	2.2	54	0.8
C-348898	5032	Lee	<0.2	0.7	104.0	<0.1	4.4	0.5	1.3	39	0.3
C-348792	9128	Lee	0.5	1.7	103.0	<0.1	8.8	0.5	2.6	66	1.0
C-348679	9128	Lee	0.4	1.4	103.0	<0.1	8.9	0.5	2.5	62	1.0
C-348899	9128	Lee	<0.2	0.8	95.6	<0.1	5.8	0.4	1.4	45	0.4
C-348586	680	Logan	0.4	1.5	99.7	<0.1	11.5	0.6	3.5	64	1.3
C-348593	680	Logan	0.5	1.6	92.6	<0.1	10.3	0.6	3.0	64	1.3
C-348600	680	Logan	<0.2	1.3	120.0	<0.1	9.9	0.6	2.6	74	1.2
C-348609	8872	Logan	0.4	1.2	108.0	<0.1	9.8	0.6	2.9	51	1.1
C-348636	8872	Logan	0.4	1.5	102.0	<0.1	10.3	0.5	3.1	56	1.2
C-348748	8872	Logan	0.2	1.5	114.0	<0.1	11.2	0.7	3.1	86	1.1
C-348911	264	Madison	0.4	3.4	121.0	<0.1	8.0	0.4	3.2	42	0.8
C-348829	264	Madison	0.5	4.5	121.0	<0.1	7.4	0.4	3.0	45	0.7
C-348480	264	Madison	<0.2	1.3	131.0	<0.1	10.3	0.6	2.4	63	0.8
C-348406	4084	Marion	0.5	4.3	91.7	<0.1	8.1	0.4	2.7	33	0.7
C-348816	4084	Marion	0.5	1.7	96.2	<0.1	9.0	0.5	3.0	49	1.4
C-348577	4084	Marion	<0.2	1.1	124.0	<0.1	8.7	0.5	2.3	59	0.9
C-348405	5108	Marion	0.4	1.1	85.2	<0.1	9.7	0.6	2.8	44	0.8
C-348815	5108	Marion	0.5	1.1	88.5	<0.1	8.7	0.5	2.6	52	0.9
C-348576	5108	Marion	<0.2	1.1	91.6	<0.1	7.6	0.4	2.2	55	0.8
C-348619	1960	Marshall	0.6	2.2	94.9	<0.1	10.4	0.6	3.6	69	1.3
C-348646	1960	Marshall	0.6	1.4	93.4	<0.1	10.5	0.7	3.6	64	1.3
C-348758	1960	Marshall	<0.2	1.3	133.0	<0.1	10.6	0.7	2.9	87	1.0
C-348606	6568	McLean	0.4	1.6	101.0	<0.1	10.6	0.6	3.4	69	1.1

Continued on next page

Electronic Filing: Received, Clerk's Office 3/24/2022

Lab no.	Site ID	County	Se (mg/kg)	Sn (mg/kg)	Sr (mg/kg)	Te (mg/kg)	Th (mg/kg)	Tl (mg/kg)	U (mg/kg)	V (mg/kg)	W (mg/kg)
C-348633	6568	McLean	0.4	1.8	92.6	<0.1	9.9	0.5	3.2	64	1.1
C-348745	6568	McLean	<0.2	1.7	91.5	<0.1	10.9	0.8	3.4	92	1.1
C-348587	6824	McDonough	0.4	2.6	95.5	<0.1	10.2	0.5	3.1	59	1.1
C-348594	6824	McDonough	0.5	1.4	102.0	<0.1	10.9	0.5	3.1	65	1.2
C-348601	6824	McDonough	<0.2	1.2	113.0	<0.1	9.4	0.5	2.0	64	1.1
C-348625	12968	McDonough	0.6	1.1	114.0	<0.1	9.7	0.4	2.6	41	1.0
C-348652	12968	McDonough	0.7	2.2	112.0	<0.1	9.9	0.5	2.8	54	1.2
C-348764	12968	McDonough	<0.2	1.3	134.0	<0.1	10.7	0.7	2.7	93	1.0
C-348789	2104	McHenry	0.5	1.6	75.9	<0.1	8.1	0.5	2.4	73	1.0
C-348676	2104	McHenry	0.4	1.4	79.2	<0.1	8.4	0.6	2.6	71	0.9
C-348896	2104	McHenry	<0.2	1.3	108.0	<0.1	6.2	0.5	1.9	57	0.6
C-348607	10664	McLean	0.6	1.6	92.5	<0.1	10.4	0.6	3.5	75	1.1
C-348634	10664	McLean	0.6	1.5	92.2	<0.1	11.1	0.6	3.7	76	1.3
C-348746	10664	McLean	<0.2	1.0	87.0	<0.1	5.2	0.4	1.7	42	0.7
C-348623	3816	Mercer	0.2	1.0	142.0	<0.1	8.9	0.4	2.3	42	0.9
C-348650	3816	Mercer	0.3	1.1	143.0	<0.1	8.5	0.5	2.3	50	1.5
C-348762	3816	Mercer	<0.2	1.1	184.0	<0.1	8.4	0.5	2.1	72	0.8
C-348916	1288	Montgomery	0.3	0.7	104.0	<0.1	6.2	0.3	1.7	32	0.5
C-348834	1288	Montgomery	0.3	0.9	101.0	<0.1	7.4	0.4	2.0	39	0.6
C-348485	1288	Montgomery	<0.2	1.5	100.0	<0.1	9.0	0.6	2.4	68	0.9
C-348912	7176	Morgan	0.3	0.8	99.8	<0.1	7.6	0.4	2.1	33	0.5
C-348830	7176	Morgan	0.4	1.0	102.0	<0.1	7.7	0.4	2.1	44	0.6
C-348481	7176	Morgan	<0.2	1.1	80.7	<0.1	7.5	0.5	2.0	59	0.5
C-348915	9480	Morgan	0.3	1.0	108.0	<0.1	9.0	0.5	2.8	58	0.7
C-348833	9480	Morgan	0.4	1.2	103.0	<0.1	9.9	0.6	3.0	63	0.9
C-348484	9480	Morgan	<0.2	1.3	137.0	<0.1	9.1	0.6	2.4	74	0.9
C-348618	3752	Peoria	0.5	3.9	91.2	<0.1	9.8	0.6	3.0	66	1.1
C-348645	3752	Peoria	0.6	2.2	93.2	<0.1	10.7	0.7	3.1	62	1.3
C-348757	3752	Peoria	<0.2	0.9	108.0	<0.1	6.4	0.5	1.9	54	0.6
C-348612	10248	Pike	0.4	1.5	124.0	<0.1	9.2	0.5	2.6	40	1.0
C-348639	10248	Pike	0.3	1.2	109.0	<0.1	8.5	0.4	2.3	35	0.8
C-348751	10248	Pike	<0.2	1.2	132.0	<0.1	9.7	0.6	2.6	67	0.9
C-348392	13044	Pope	0.4	1.1	96.3	<0.1	9.0	0.5	2.7	33	0.7
C-348802	13044	Pope	0.5	0.8	148.0	<0.1	4.3	0.3	1.5	21	0.6
C-348563	13044	Pope	<0.2	1.3	139.0	<0.1	9.5	0.5	2.6	68	1.1
C-348388	2804	Randolph	0.2	1.0	103.0	<0.1	8.6	0.5	2.4	34	0.5
C-348798	2804	Randolph	0.3	1.0	106.0	<0.1	8.5	0.4	2.3	40	0.7
C-348559	2804	Randolph	<0.2	1.4	159.0	<0.1	9.9	0.5	2.1	75	1.1
C-348389	8200	Randolph	<0.2	0.9	115.0	<0.1	9.3	0.5	2.6	41	0.8
C-348799	8200	Randolph	0.3	0.9	120.0	<0.1	8.4	0.5	2.4	45	1.0
C-348560	8200	Randolph	<0.2	1.5	136.0	<0.1	10.7	0.7	2.8	83	1.3
C-348402	1516	Richland	0.4	1.3	84.9	<0.1	9.5	0.5	3.0	46	0.8
C-348812	1516	Richland	0.4	1.2	91.8	<0.1	7.5	0.4	2.4	55	0.9
C-348573	1516	Richland	<0.2	1.2	97.9	<0.1	9.2	0.5	2.3	56	1.0
C-348394	9972	Saline	0.4	3.0	87.6	<0.1	9.5	0.5	3.0	45	0.8
C-348804	9972	Saline	0.4	1.2	85.9	<0.1	9.7	0.5	3.1	53	1.1
C-348565	9972	Saline	<0.2	1.4	127.0	<0.1	10.1	0.5	2.8	66	1.1
C-348610	11944	Sangamon	0.5	1.1	99.6	<0.1	9.7	0.5	3.2	55	1.1
C-348637	11944	Sangamon	0.5	1.1	104.0	<0.1	10.0	0.4	3.2	60	1.0
C-348749	11944	Sangamon	<0.2	1.3	118.0	<0.1	9.4	0.5	2.4	60	0.9
C-348616	2728	Schuyler	0.5	1.0	111.0	<0.1	9.8	0.4	3.0	57	1.0
C-348643	2728	Schuyler	0.6	1.1	109.0	<0.1	10.2	0.5	3.2	58	1.3
C-348755	2728	Schuyler	<0.2	1.4	128.0	<0.1	10.8	0.6	2.8	81	1.0
C-348909	4104	St. Clair	0.5	1.1	121.0	<0.1	7.9	0.5	2.7	47	0.8
C-348827	4104	St. Clair	0.5	1.4	127.0	<0.1	7.7	0.5	2.5	52	0.8
C-348478	4104	St. Clair	<0.2	1.5	134.0	<0.1	11.5	0.8	3.1	86	1.0
C-348621	4008	Stephenson	0.5	1.5	110.0	<0.1	9.7	0.5	2.6	65	1.0
C-348648	4008	Stephenson	0.6	1.4	97.5	<0.1	10.2	0.6	2.8	59	1.1

Continued on next page

Electronic Filing: Received, Clerk's Office 3/24/2022

Lab no.	Site ID	County	Se (mg/kg)	Sn (mg/kg)	Sr (mg/kg)	Te (mg/kg)	Th (mg/kg)	Tl (mg/kg)	U (mg/kg)	V (mg/kg)	W (mg/kg)
C-348760	4008	Stephenson	<0.2	1.5	129.0	<0.1	10.0	0.6	2.6	88	1.1
C-348793	5096	Stephenson	0.6	1.6	106.0	<0.1	9.6	0.6	2.6	72	1.2
C-348680	5096	Stephenson	0.5	1.3	108.0	<0.1	9.7	0.6	2.7	69	1.0
C-348900	5096	Stephenson	<0.2	1.0	112.0	<0.1	6.7	0.5	1.8	64	0.6
C-348603	9192	Stephenson	0.5	1.8	107.0	<0.1	9.5	0.5	2.8	64	1.2
C-348630	9192	Stephenson	0.5	2.1	106.0	<0.1	9.3	0.5	2.7	58	1.0
C-348742	9192	Stephenson	<0.2	2.3	58.2	<0.1	12.7	0.8	2.8	125	1.3
C-348617	10920	Tazewell	0.4	5.1	90.9	<0.1	5.1	0.4	1.6	34	0.6
C-348644	10920	Tazewell	0.4	3.6	93.0	<0.1	4.6	0.4	1.6	35	0.7
C-348756	10920	Tazewell	0.3	1.1	91.5	<0.1	5.4	0.4	1.7	39	0.6
C-348401	9204	Wayne	0.3	0.9	74.5	<0.1	7.2	0.3	2.4	36	0.5
C-348811	9204	Wayne	0.3	0.9	73.8	<0.1	7.3	0.3	2.5	37	0.8
C-348572	9204	Wayne	0.2	1.1	90.0	<0.1	8.5	0.5	2.6	58	0.9
C-348400	12020	White	0.5	3.9	131.0	<0.1	8.6	0.5	3.1	46	0.7
C-348810	12020	White	0.5	3.2	109.0	<0.1	8.0	0.4	2.8	47	1.0
C-348571	12020	White	<0.2	1.5	123.0	<0.1	8.6	0.6	2.5	72	1.0
C-348398	5356	White	0.4	1.5	84.3	<0.1	11.1	0.7	3.7	64	0.8
C-348808	5356	White	0.4	2.2	90.1	<0.1	10.2	0.6	3.2	77	1.2
C-348569	5356	White	<0.2	1.2	95.3	<0.1	8.8	0.5	2.3	72	0.9
C-348771	936	Whiteside	0.5	0.9	98.2	<0.1	4.4	0.3	1.3	41	0.4
C-348659	936	Whiteside	0.5	1.1	115.0	<0.1	6.6	0.4	1.9	55	0.7
C-348878	936	Whiteside	0.5	0.8	114.0	<0.1	5.8	0.3	1.4	44	0.5
C-348627	7080	Whiteside	0.5	1.3	99.4	<0.1	9.9	0.5	2.4	67	1.0
C-348654	7080	Whiteside	0.4	1.7	104.0	<0.1	9.1	0.6	2.4	68	1.0
C-348766	7080	Whiteside	<0.2	1.0	131.0	<0.1	8.0	0.5	1.6	80	0.7
C-348783	12712	Will	0.4	2.1	89.4	<0.1	7.0	0.5	2.4	58	0.8
C-348671	12712	Will	0.3	1.6	89.7	<0.1	7.4	0.5	2.5	57	0.9
C-348890	12712	Will	<0.2	0.7	87.9	<0.1	3.8	0.4	1.7	43	0.4
C-348395	5876	Williamson	0.4	1.2	97.3	<0.1	9.8	0.5	2.8	63	0.6
C-348805	5876	Williamson	0.4	1.4	98.3	<0.1	10.3	0.5	3.1	69	1.2
C-348566	5876	Williamson	<0.2	1.3	104.0	<0.1	9.7	0.5	2.4	70	1.0
C-348390	6900	Williamson	0.5	1.3	94.3	<0.1	9.6	0.6	2.7	49	1.0
C-348800	6900	Williamson	0.5	1.5	101.0	<0.1	8.8	0.5	2.5	52	1.0
C-348561	6900	Williamson	0.2	1.6	105.0	<0.1	11.9	0.7	3.4	89	1.3

Continued on next page

Electronic Filing: Received, Clerk's Office 3/24/2022

Lab no.	Site ID	County	Y (mg/kg)	Zn (mg/kg)
C-348582	9896	Adams	28.3	69
C-348589	9896	Adams	17.2	56
C-348596	9896	Adams	17.0	50
C-348613	12200	Adams	18.2	61
C-348640	12200	Adams	19.5	59
C-348752	12200	Adams	25.5	70
C-348387	13128	Alexander	14.2	99
C-348797	13128	Alexander	17.4	89
C-348558	13128	Alexander	22.8	126
C-348407	11252	Bond	14.6	54
C-348817	11252	Bond	15.0	58
C-348578	11252	Bond	32.3	44
C-348790	6200	Boone	14.9	74
C-348677	6200	Boone	15.0	68
C-348897	6200	Boone	24.2	52
C-348772	6056	Bureau	12.1	201
C-348660	6056	Bureau	12.8	220
C-348879	6056	Bureau	8.7	71
C-348913	3080	Calhoun	14.4	45
C-348831	3080	Calhoun	17.4	41
C-348482	3080	Calhoun	24.1	64
C-348611	7848	Cass	18.2	82
C-348638	7848	Cass	17.9	89
C-348750	7848	Cass	21.1	69
C-348583	2472	Champaign	23.4	92
C-348590	2472	Champaign	21.4	77
C-348597	2472	Champaign	20.6	73
C-348604	7592	Champaign	19.0	71
C-348631	7592	Champaign	19.6	60
C-348743	7592	Champaign	15.0	55
C-348605	9640	Champaign	16.5	77
C-348632	9640	Champaign	16.1	68
C-348744	9640	Champaign	22.3	81
C-348918	2036	Christian	16.6	95
C-348836	2036	Christian	17.8	95
C-348487	2036	Christian	23.2	60
C-348919	6132	Christian	20.8	179
C-348837	6132	Christian	22.9	288
C-348488	6132	Christian	21.3	52
C-348920	10228	Christian	12.0	60
C-348838	10228	Christian	13.9	58
C-348489	10228	Christian	22.2	76
C-348908	492	Clark	15.7	50
C-348826	492	Clark	15.7	46
C-348477	492	Clark	22.4	58
C-348923	4588	Clark	17.0	51
C-348841	4588	Clark	17.4	46
C-348492	4588	Clark	20.6	46
C-348922	11500	Clark	13.9	45
C-348840	11500	Clark	13.2	42
C-348491	11500	Clark	20.3	34
C-348403	1012	Clay	10.6	48
C-348813	1012	Clay	11.8	46
C-348574	1012	Clay	15.3	54

*Continued on next page*

Electronic Filing: Received, Clerk's Office 3/24/2022

Lab no.	Site ID	County	Y (mg/kg)	Zn (mg/kg)
C-348904	10996	Clinton	13.1	110
C-348822	10996	Clinton	14.3	128
C-348473	10996	Clinton	20.1	70
C-348906	3060	Coles	17.7	70
C-348824	3060	Coles	17.3	69
C-348475	3060	Coles	12.9	61
C-348921	7156	Coles	7.4	34
C-348839	7156	Coles	9.2	39
C-348490	7156	Coles	8.9	36
C-348786	1448	Cook	15.6	188
C-348673	1448	Cook	18.1	141
C-348893	1448	Cook	15.6	67
C-348784	5544	Cook	11.4	79
C-348672	5544	Cook	12.8	75
C-348891	5544	Cook	16.3	80
C-348788	10296	Cook	17.7	83
C-348675	10296	Cook	18.1	86
C-348895	10296	Cook	14.8	66
C-348404	8684	Crawford	11.8	69
C-348814	8684	Crawford	12.6	71
C-348575	8684	Crawford	18.7	38
C-348682	4776	Dewitt	17.2	103
C-348655	4776	Dewitt	17.7	101
C-348767	4776	Dewitt	14.7	52
C-348818	3496	Douglas	15.8	84
C-348819	3496	Douglas	18.5	80
C-348579	3496	Douglas	12.2	39
C-348905	11688	Douglas	17.8	79
C-348823	11688	Douglas	16.7	88
C-348474	11688	Douglas	16.6	64
C-348907	6672	Edgar	9.0	113
C-348825	6672	Edgar	12.0	99
C-348476	6672	Edgar	15.6	56
C-348585	1704	Fulton	28.4	72
C-348592	1704	Fulton	14.7	47
C-348599	1704	Fulton	14.9	40
C-348914	5384	Greene	15.9	301
C-348832	5384	Greene	14.9	147
C-348483	5384	Greene	18.0	71
C-348775	6312	Grundy	18.7	99
C-348663	6312	Grundy	19.3	97
C-348882	6312	Grundy	12.2	40
C-348776	11432	Grundy	18.2	114
C-348664	11432	Grundy	19.9	117
C-348883	11432	Grundy	23.1	83
C-348397	7924	Hamilton	12.4	75
C-348807	7924	Hamilton	15.8	71
C-348568	7924	Hamilton	27.9	67
C-348615	8104	Hancock	16.4	103
C-348642	8104	Hancock	16.1	127
C-348754	8104	Hancock	17.7	41
C-348624	1256	Henderson	7.4	42
C-348651	1256	Henderson	7.4	37
C-348763	1256	Henderson	6.6	14
C-348778	4520	Iroquois	14.9	93

Continued on next page

Electronic Filing: Received, Clerk's Office 3/24/2022

Lab no.	Site ID	County	Y (mg/kg)	Zn (mg/kg)
C-348666	4520	Iroquois	15.6	89
C-348885	4520	Iroquois	15.9	85
C-348781	9744	Iroquois	15.4	88
C-348669	9744	Iroquois	16.6	84
C-348888	9744	Iroquois	17.9	76
C-348396	3828	Jefferson	12.5	42
C-348806	3828	Jefferson	16.1	43
C-348567	3828	Jefferson	21.9	52
C-348794	8168	Jo Daviess	15.9	92
C-348681	8168	Jo Daviess	17.8	89
C-348901	8168	Jo Daviess	22.7	57
C-348391	1780	Johnson	14.2	60
C-348801	1780	Johnson	16.0	62
C-348562	1780	Johnson	22.4	52
C-348785	10408	Kane	14.8	116
C-348768	10408	Kane	15.2	139
C-348892	10408	Kane	16.6	78
C-348780	424	Kankakee	19.0	62
C-348668	424	Kankakee	20.2	59
C-348887	424	Kankakee	21.6	64
C-348782	7952	Kankakee	6.1	35
C-348670	7952	Kankakee	7.4	41
C-348889	7952	Kankakee	3.0	9
C-348777	8616	Kankakee	16.2	85
C-348665	8616	Kankakee	16.8	86
C-348884	8616	Kankakee	17.6	87
C-348626	5800	Knox	17.3	68
C-348653	5800	Knox	18.3	65
C-348765	5800	Knox	27.4	74
C-348620	10152	Knox	19.5	47
C-348647	10152	Knox	21.7	41
C-348759	10152	Knox	22.6	74
C-348774	3240	LaSalle	20.1	82
C-348662	3240	LaSalle	19.2	78
C-348881	3240	LaSalle	17.2	89
C-348773	7336	LaSalle	15.6	82
C-348661	7336	LaSalle	15.8	85
C-348880	7336	LaSalle	13.3	53
C-348791	5032	Lee	14.6	83
C-348678	5032	Lee	15.4	86
C-348898	5032	Lee	12.3	39
C-348792	9128	Lee	17.7	78
C-348679	9128	Lee	16.8	74
C-348899	9128	Lee	13.3	42
C-348586	680	Logan	21.4	79
C-348593	680	Logan	18.3	75
C-348600	680	Logan	22.8	78
C-348609	8872	Logan	19.1	72
C-348636	8872	Logan	19.9	83
C-348748	8872	Logan	25.7	84
C-348911	264	Madison	15.1	150
C-348829	264	Madison	14.0	149
C-348480	264	Madison	18.5	47
C-348406	4084	Marion	9.0	143
C-348816	4084	Marion	12.6	102

Continued on next page



## Electronic Filing: Received, Clerk's Office 3/24/2022

Lab no.	Site ID	County	Y (mg/kg)	Zn (mg/kg)
C-348577	4084	Marion	20.3	39
C-348405	5108	Marion	14.6	50
C-348815	5108	Marion	17.9	50
C-348576	5108	Marion	17.1	39
C-348619	1960	Marshall	18.8	80
C-348646	1960	Marshall	18.9	81
C-348758	1960	Marshall	27.2	77
C-348606	6568	McLean	20.4	84
C-348633	6568	McLean	19.0	73
C-348745	6568	McLean	24.4	93
C-348587	6824	McDonough	18.3	67
C-348594	6824	McDonough	19.1	71
C-348601	6824	McDonough	20.6	44
C-348625	12968	McDonough	16.2	63
C-348652	12968	McDonough	17.7	61
C-348764	12968	McDonough	28.6	77
C-348789	2104	McHenry	17.5	62
C-348676	2104	McHenry	17.7	58
C-348896	2104	McHenry	14.8	48
C-348607	10664	McLean	18.8	123
C-348634	10664	McLean	20.0	108
C-348746	10664	McLean	11.2	75
C-348623	3816	Mercer	18.1	48
C-348650	3816	Mercer	18.4	48
C-348762	3816	Mercer	19.6	47
C-348916	1288	Montgomery	12.0	70
C-348834	1288	Montgomery	13.8	54
C-348485	1288	Montgomery	20.6	47
C-348912	7176	Morgan	15.9	41
C-348830	7176	Morgan	15.4	40
C-348481	7176	Morgan	13.8	53
C-348915	9480	Morgan	16.1	57
C-348833	9480	Morgan	16.9	59
C-348484	9480	Morgan	22.3	50
C-348618	3752	Peoria	18.0	101
C-348645	3752	Peoria	19.2	97
C-348757	3752	Peoria	14.9	47
C-348612	10248	Pike	20.1	119
C-348639	10248	Pike	18.6	91
C-348751	10248	Pike	22.0	67
C-348392	13044	Pope	18.0	55
C-348802	13044	Pope	24.9	75
C-348563	13044	Pope	24.3	55
C-348388	2804	Randolph	9.5	27
C-348798	2804	Randolph	11.9	29
C-348559	2804	Randolph	29.5	60
C-348389	8200	Randolph	15.2	50
C-348799	8200	Randolph	17.2	51
C-348560	8200	Randolph	24.6	80
C-348402	1516	Richland	13.9	49
C-348812	1516	Richland	13.7	47
C-348573	1516	Richland	31.4	41
C-348394	9972	Saline	14.6	64
C-348804	9972	Saline	19.0	70

*Continued on next page*

Electronic Filing: Received, Clerk's Office 3/24/2022

Lab no.	Site ID	County	Y (mg/kg)	Zn (mg/kg)
C-348565	9972	Saline	28.4	59
C-348610	11944	Sangamon	16.8	52
C-348637	11944	Sangamon	16.2	56
C-348749	11944	Sangamon	22.7	69
C-348616	2728	Schuyler	15.1	44
C-348643	2728	Schuyler	16.1	47
C-348755	2728	Schuyler	24.1	63
C-348909	4104	St. Clair	13.9	95
C-348827	4104	St. Clair	13.7	88
C-348478	4104	St. Clair	22.1	84
C-348621	4008	Stephenson	18.3	72
C-348648	4008	Stephenson	19.5	61
C-348760	4008	Stephenson	25.4	68
C-348793	5096	Stephenson	17.0	77
C-348680	5096	Stephenson	16.5	72
C-348900	5096	Stephenson	20.0	55
C-348603	9192	Stephenson	16.3	84
C-348630	9192	Stephenson	16.1	73
C-348742	9192	Stephenson	45.1	161
C-348617	10920	Tazewell	10.4	113
C-348644	10920	Tazewell	11.1	123
C-348756	10920	Tazewell	12.9	58
C-348401	9204	Wayne	10.3	53
C-348811	9204	Wayne	13.5	61
C-348572	9204	Wayne	17.9	40
C-348400	12020	White	11.6	111
C-348810	12020	White	13.4	102
C-348571	12020	White	20.1	66
C-348398	5356	White	15.0	102
C-348808	5356	White	17.1	102
C-348569	5356	White	15.4	62
C-348771	936	Whiteside	11.4	52
C-348659	936	Whiteside	15.9	66
C-348878	936	Whiteside	13.7	60
C-348627	7080	Whiteside	20.2	92
C-348654	7080	Whiteside	20.5	98
C-348766	7080	Whiteside	18.2	61
C-348783	12712	Will	14.8	91
C-348671	12712	Will	14.7	93
C-348890	12712	Will	12.7	68
C-348395	5876	Williamson	14.2	53
C-348805	5876	Williamson	17.6	85
C-348566	5876	Williamson	19.4	53
C-348390	6900	Williamson	10.5	48
C-348800	6900	Williamson	12.5	51
C-348561	6900	Williamson	18.7	74

Electronic Filing: Received, Clerk's Office 3/24/2022

**APPENDIX 7—BOX AND WHISKER PLOTS OF CONCENTRATIONS OF VARIOUS ELEMENTS AND COMPOUNDS IN ILLINOIS SOILS (ZHANG AND FROST 2002; DREHER AND FOLLMER SERIES; SMITH ET AL. 2013)**

Note: <sup>z</sup>Zhang and Frost (2002); <sup>d</sup>Dreher and Follmer Series (Dreher et al. 2002, 2003a, 2003b; Dreher and Follmer 2004a, 2004b, 2004c, 2005); <sup>u</sup>U.S. Geological Survey (Smith et al. 2013).

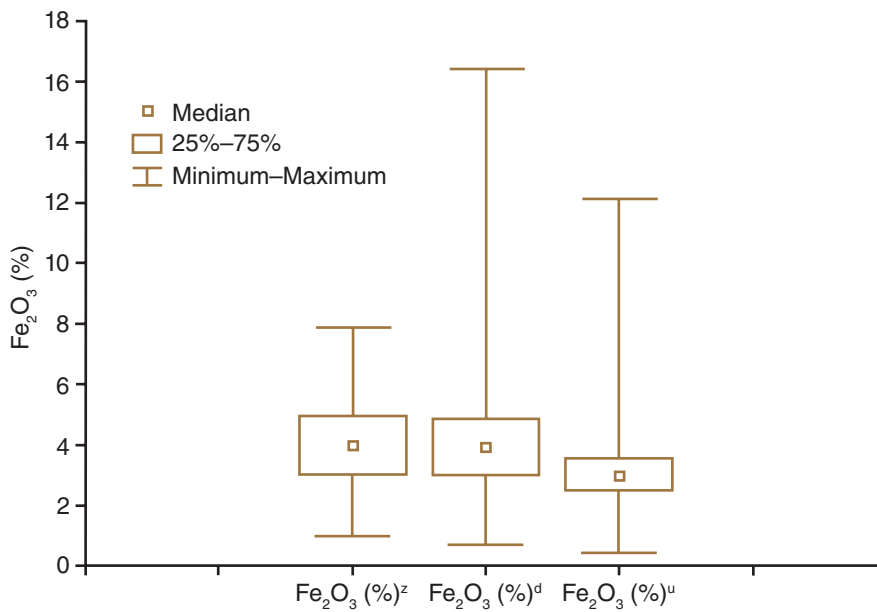
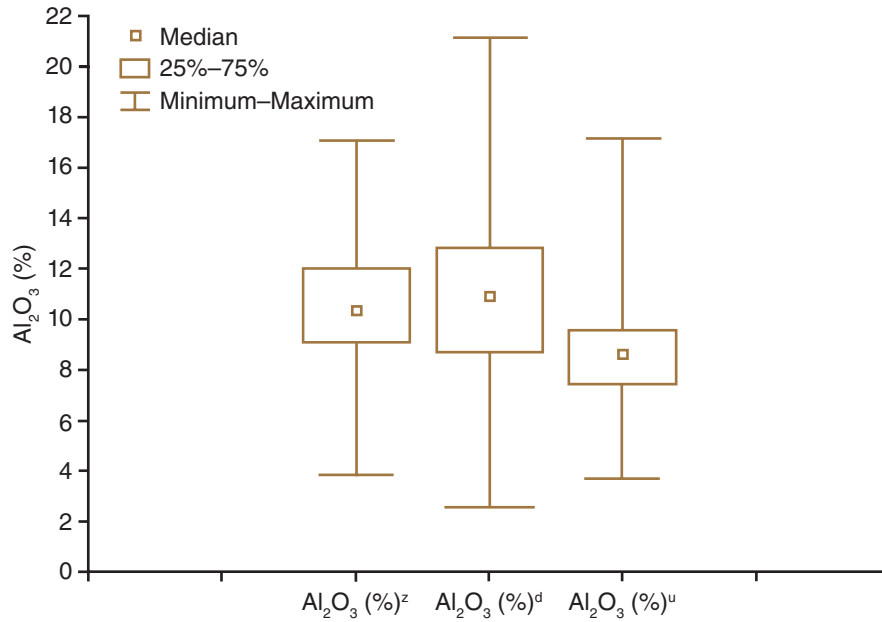

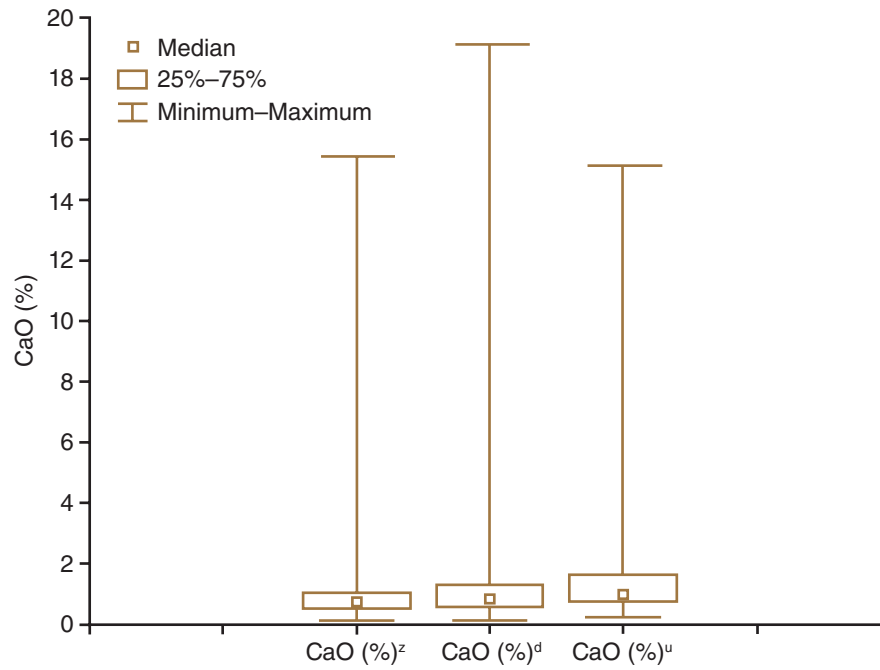
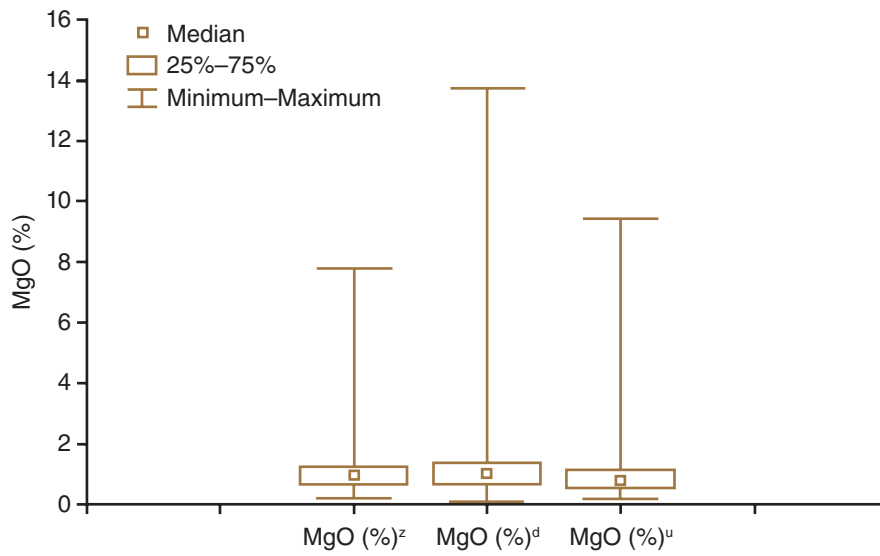

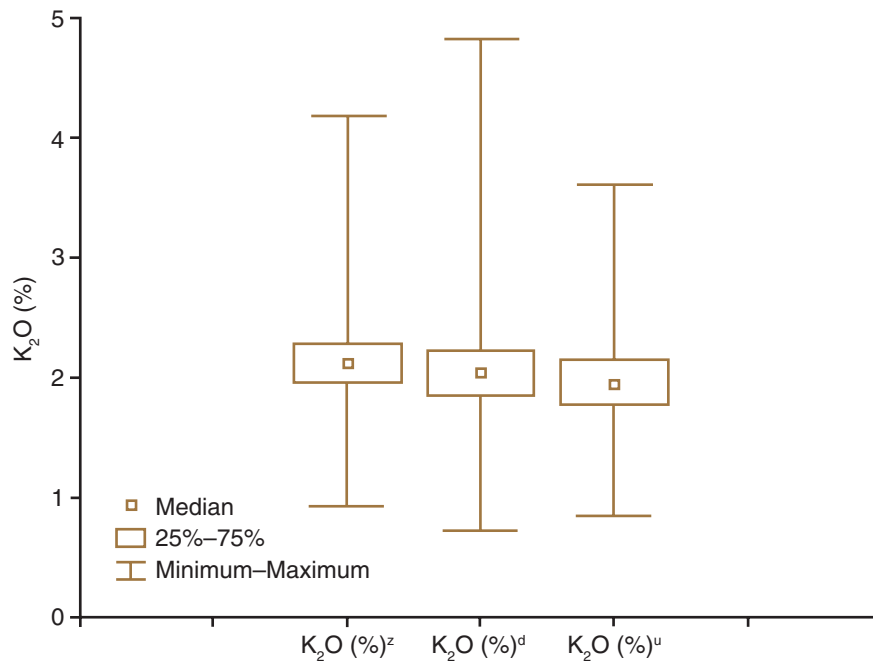
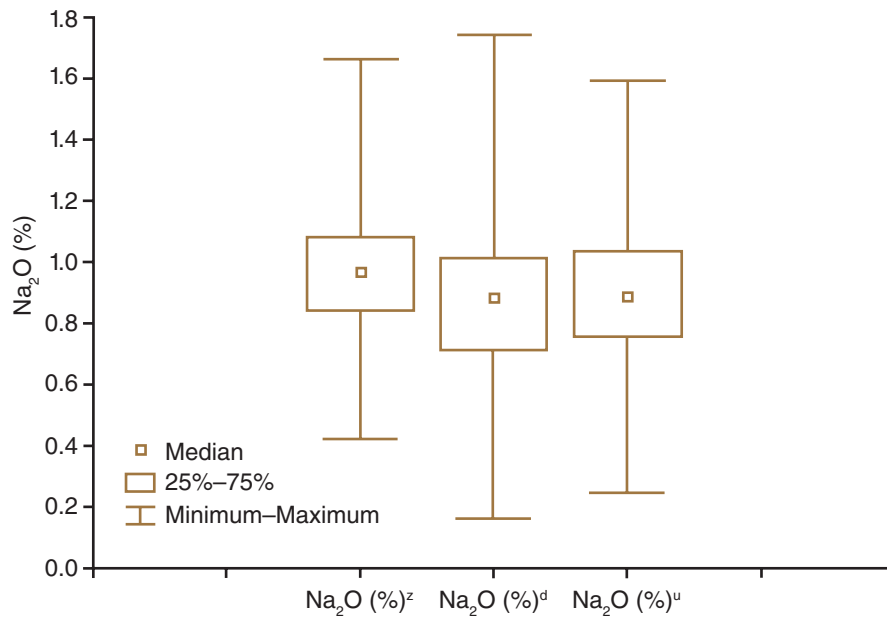



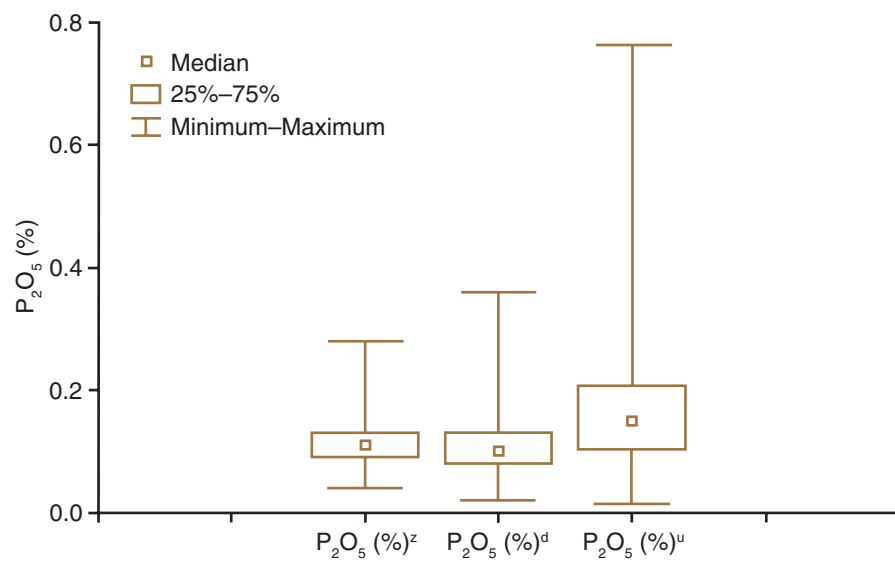
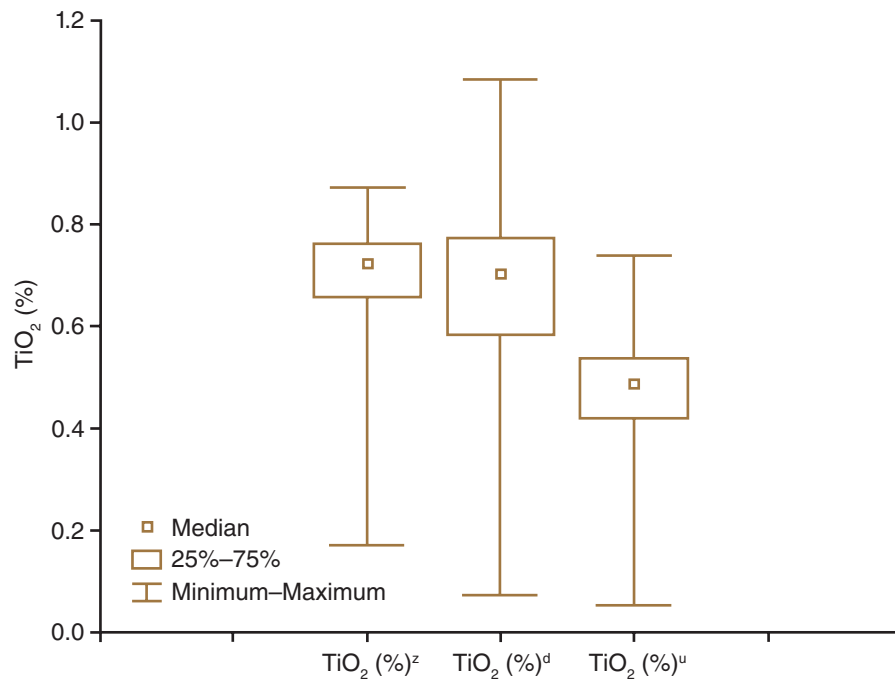

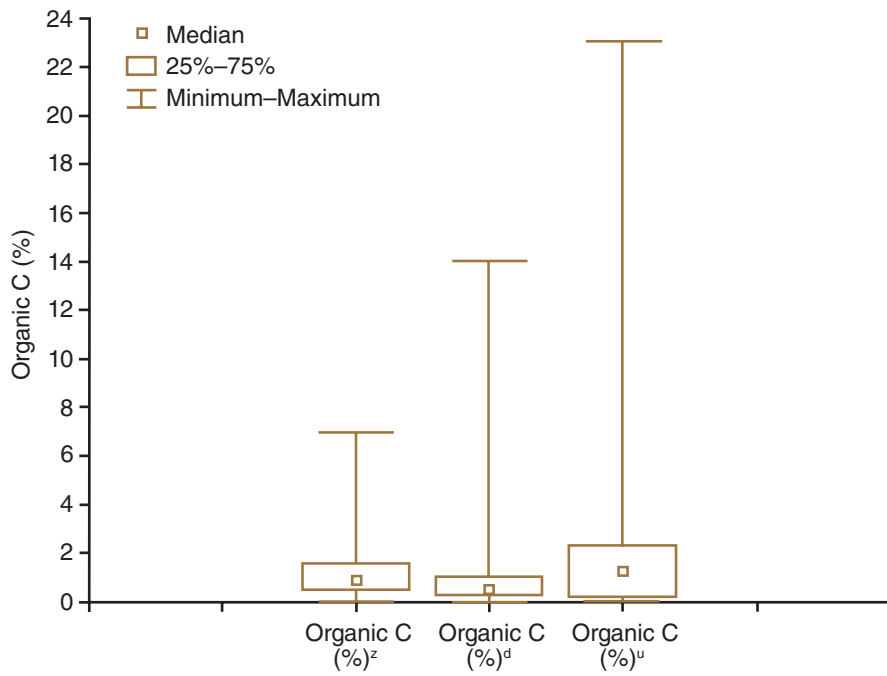
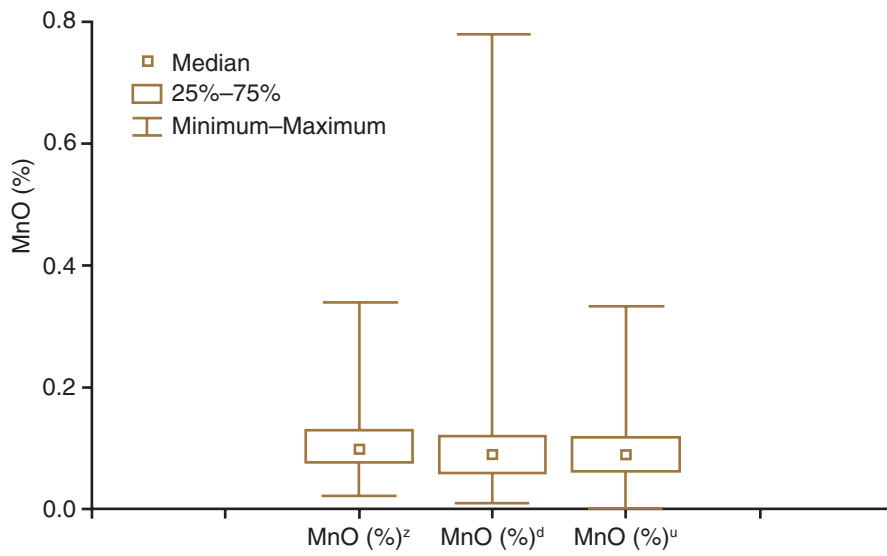

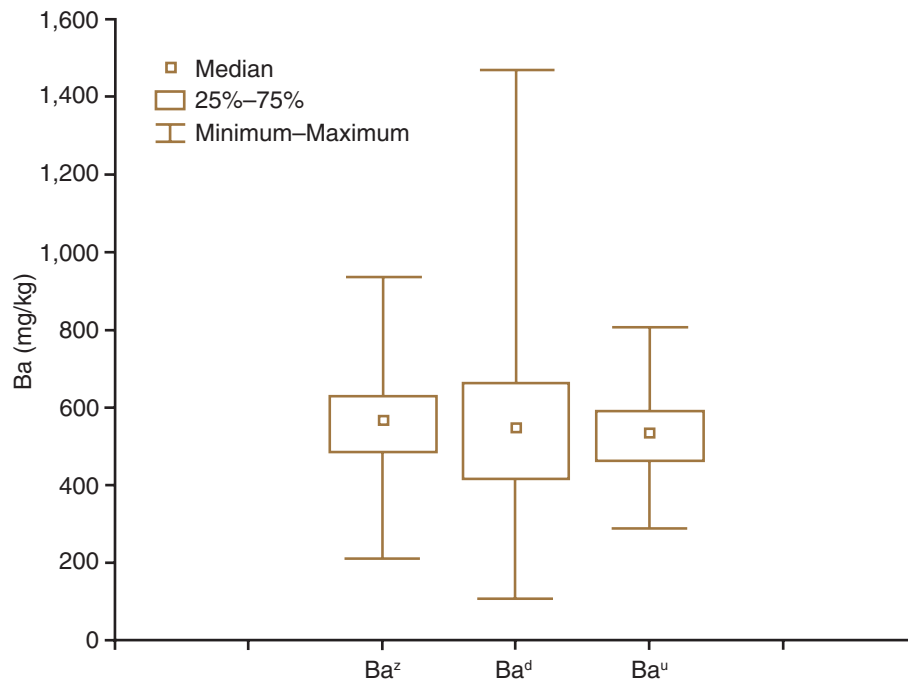
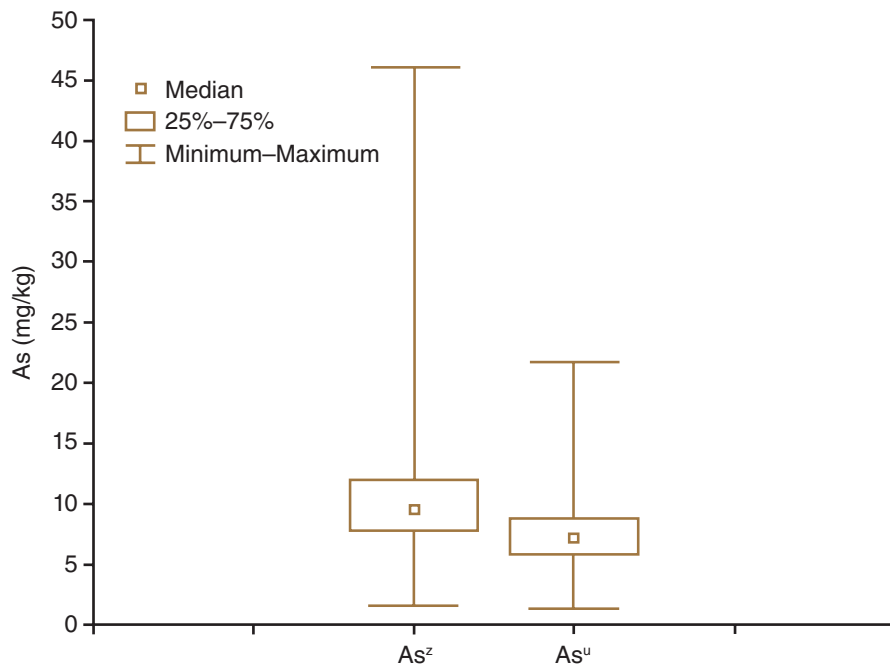

# Electronic Filing: Received, Clerk's Office 3/24/2022

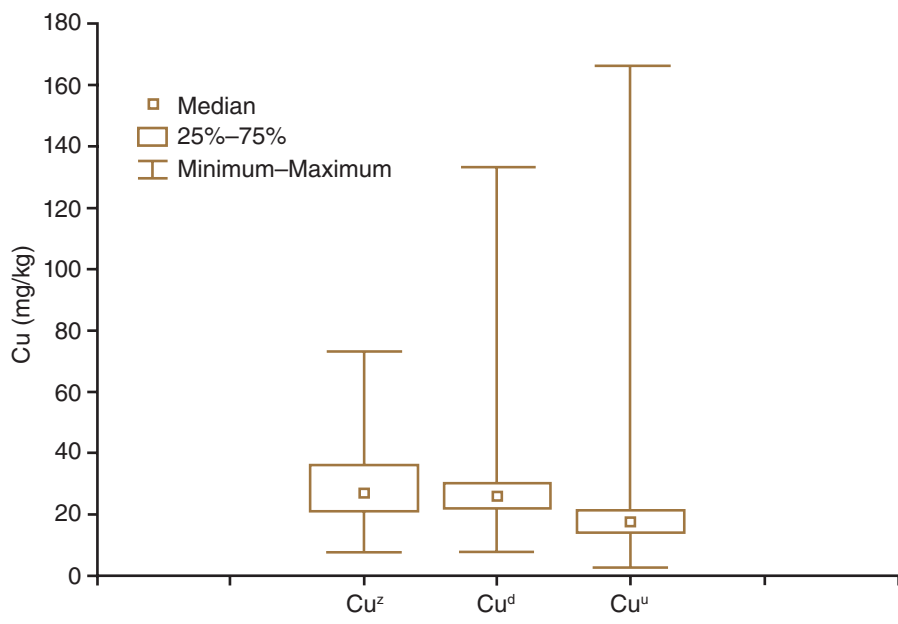
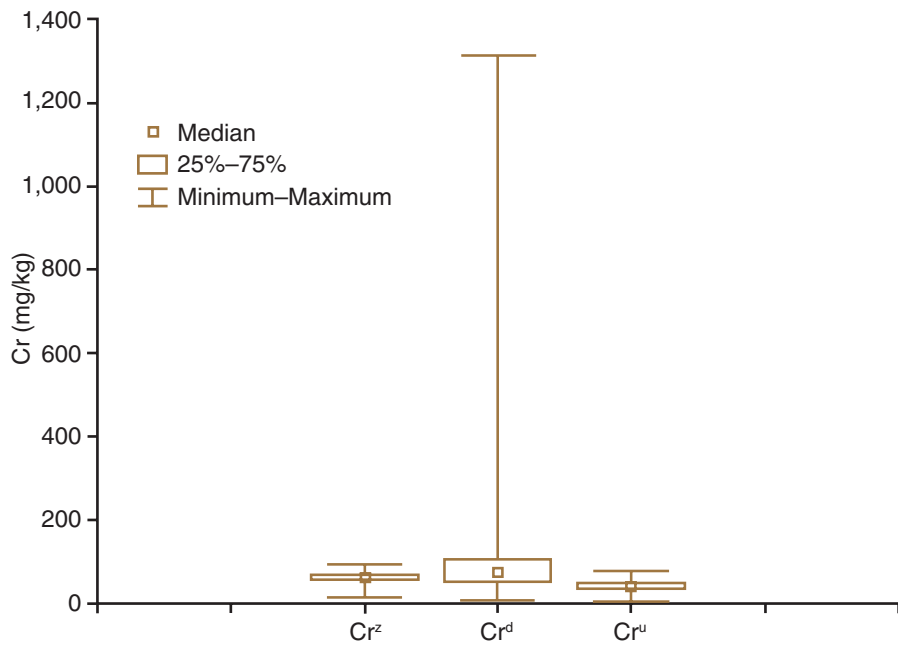

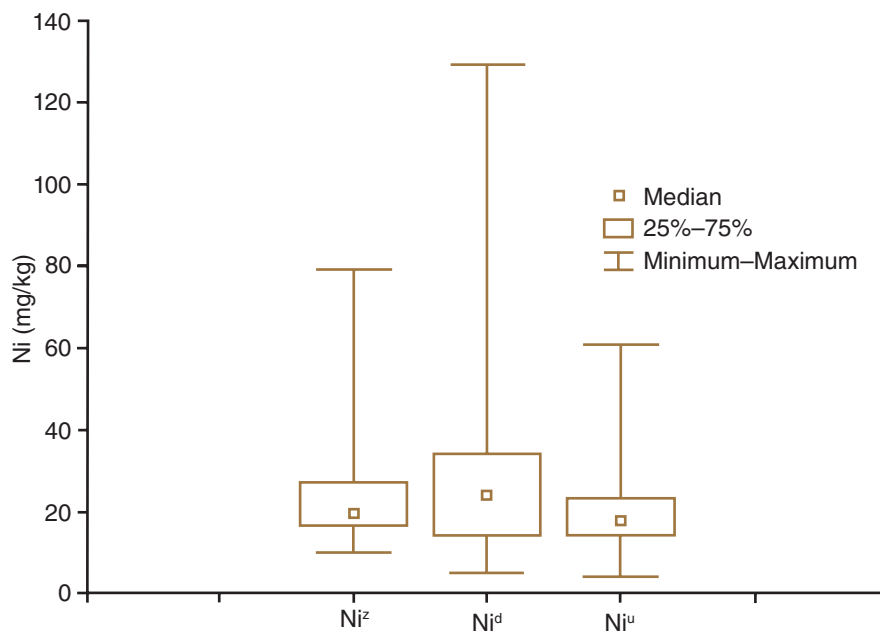
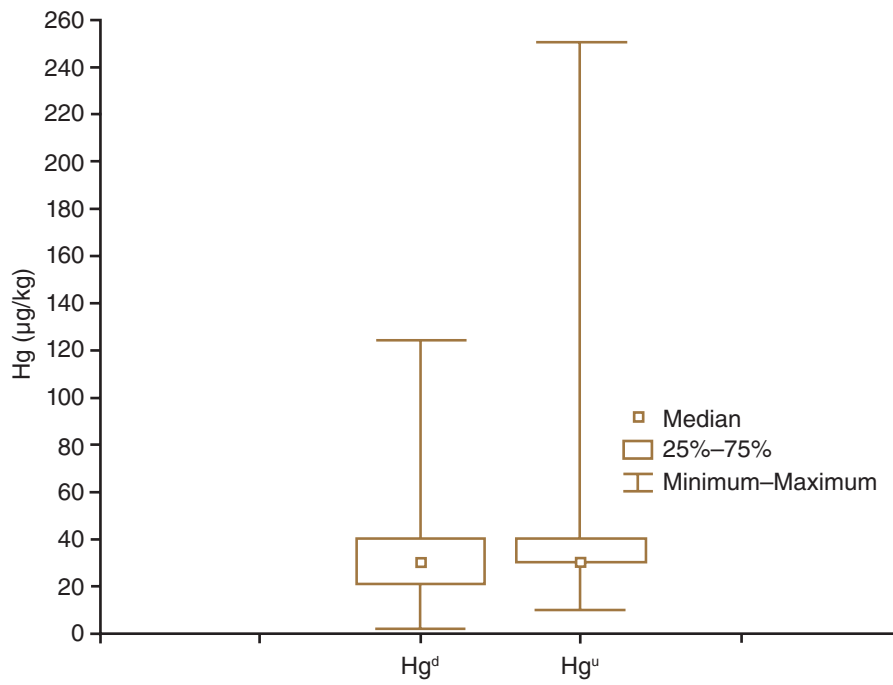

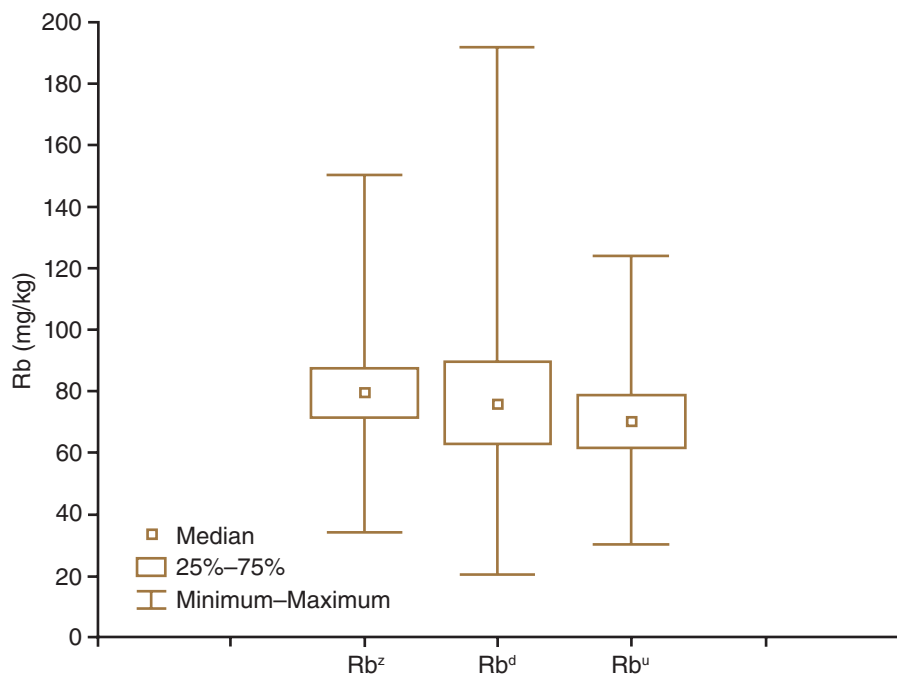
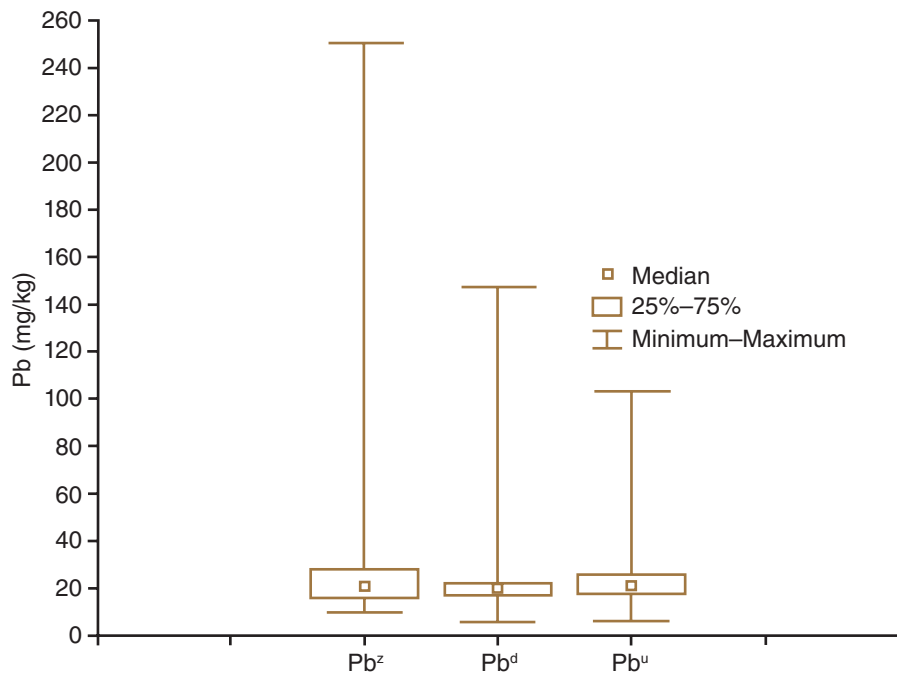

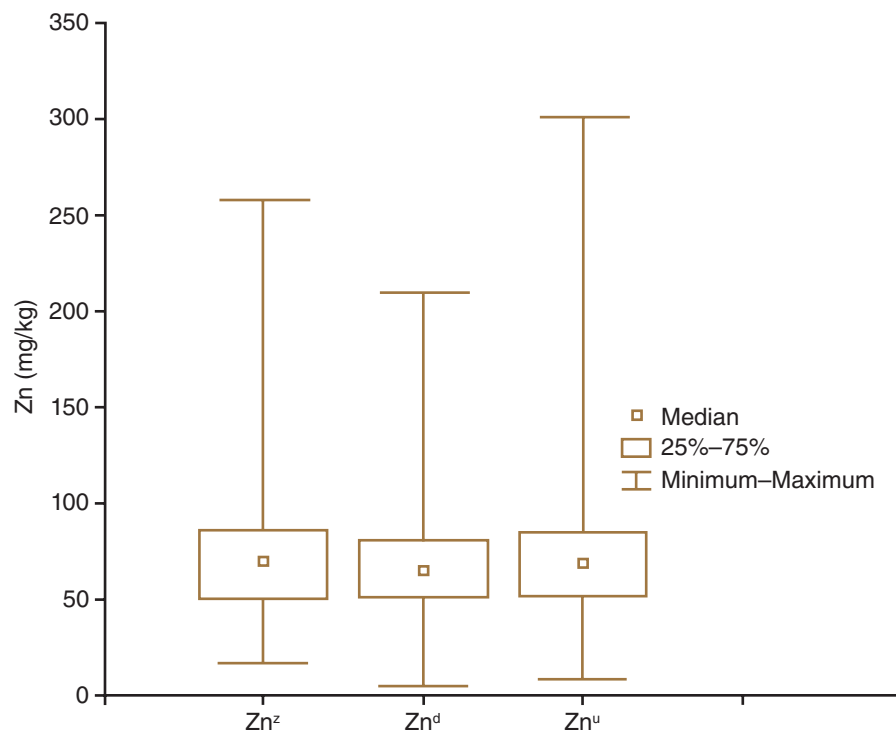
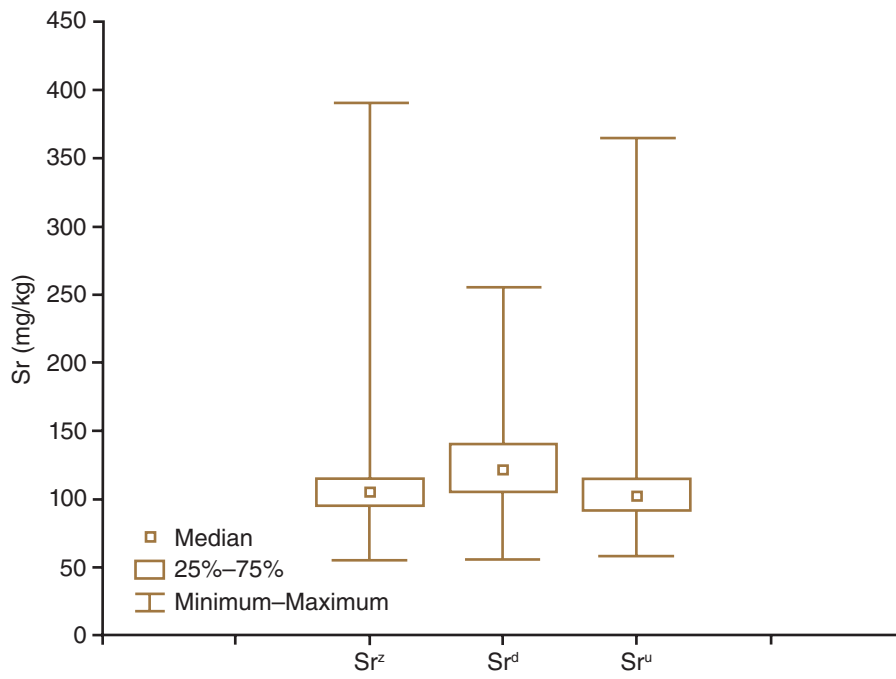



**EXHIBIT D**

**Schuler and Relyea, 2018**  
**A Review of the Combined Threats of Road Salts and Heavy Metals to**  
**Freshwater Systems**

# A Review of the Combined Threats of Road Salts and Heavy Metals to Freshwater Systems

MATTHEW S. SCHULER AND RICK A. RELYEA

*Road salts are altering and mobilizing heavy metals away from roadside soils, potentially into freshwater systems. Despite numerous studies investigating the mobilization of heavy metals by road salts, few studies have investigated (a) the movement rate and fate of heavy metals mobilized by road salts, (b) how road salts alter the bioavailable fraction of heavy metals, and (c) how road salts and heavy metals interact to affect freshwater organisms or human health. In this article, we discuss the consequences of increased concentrations of heavy metals and road salts, examine the mechanisms of heavy-metal mobilization, and highlight areas for future research. Future studies should investigate how metals and road salts alter ecosystem function and ecosystem services in freshwater habitats. Finally, increased research efforts will help assess whether the fate of heavy metals mobilized by road salts increases risks to human health by contaminating drinking water and water used for agriculture.*

*Keywords: deicers, environmental pollution, freshwater contaminants, metalloids*

## **G**lobal urbanization has vastly modified landscapes

and increased the density of impervious land cover, including parking lots and paved roads (Boving et al. 2008). Roads reduce habitat area, fragment habitats, change soil hydrology, reduce water quality, and introduce chemical pollutants (reviewed by Forman and Alexander 1998, Spellerberg 1998, Trombulak and Frissell 2000). Although roads make up a small proportion of the total surface area in a landscape (e.g., 1.2 kilometers per square kilometer in the United States; Forman and Alexander 1998), their ecological, toxicological, and human-health effects can be severe. The magnitude of the effect that a road can have on a surrounding ecosystem depends on the density of other roads, the amount of vehicle traffic, and the slope and aspect of the road within the context of other geographical features (Forman and Alexander 1998, Trombulak and Frissell 2000).

Roads are a major nonpoint source of pollution, especially during precipitation events, because storm-water runoff contains chemicals from road materials, chemicals applied to roads, contaminants from vehicles, and heavy metals from the deterioration of vehicle parts (Forman and Alexander 1998). Many toxic chemicals that are found in runoff from roads threaten the health of ecosystems along roadways, including heavy metals and road salts (i.e., deicers; Bäckström et al. 2004, Cañedo-Argüelles et al. 2016). Unlike road salts, heavy metals accumulate in roadside soils and can then be mobilized by road salts such as sodium

chloride (NaCl), magnesium chloride (MgCl<sub>2</sub>), and calcium chloride (CaCl<sub>2</sub>) into freshwater ecosystems. Salts mobilize heavy metals that are not readily bioavailable but can also transform metals to more bioavailable species (e.g., transformation to free ions, soluble species, and weakly adsorbed species; Violante et al. 2010). An increase in the bioavailable (especially free-ion) fraction of heavy metals could increase the concentrations of heavy metals in food webs (Parker et al. 1995, Peters et al. 2013). The uptake of heavy metals by plants and algae would increase as metals become dissociated from refractory organic soil compounds to become free ions (Parker and Pedler 1997) or weakly bound soil molecules (i.e., easily exchangeable ions; Violante et al. 2010). As the bioavailability fractionation of heavy metals increases (e.g., free ions and easily exchangeable ions; Violante et al. 2010), heavy metals could have greater toxicological effects on organisms. Models such as the free ion activity model (FIAM; Parker and Pedler 1997) and the biotic ligand model (e.g., Campbell et al. 2002) can be used to understand the potential toxicological effects of heavy metals on organisms. However, salts and heavy metals could interact toxicologically. In addition, salts and heavy metals could act beyond the organismal level by disrupting ecosystem functions such as microbial processes and food-web dynamics, thus reducing ecosystem services such as carbon sequestration in wetlands, ponds, and lakes. One of the greatest but poorly known threats that humans face from heavy metals and road

salts is the continuous movement and accumulation of heavy metals and salt in groundwater systems used for human consumption and agriculture (Norrström and Jacks 1998).

We provide a review of the literature regarding the effects of heavy metals, road salts, and their interactions along roads and into aquatic ecosystems. In doing so, we hope to foster discussion and future studies that will lead to predictive models that can identify freshwater systems that are threatened by road salts and heavy metals and to encourage future studies to investigate the threats that these contaminants pose to human health and ecosystem function.

### Heavy metals

*Heavy metals* are metals and metalloids that are either essential or nonessential (Bolan and Duraisamy 2003). Both are toxic to organisms at high concentrations, and their accumulation threatens the health of organisms living along roads (Li et al. 2007, Green et al. 2008) but could also cause harm in freshwater habitats and groundwater. Heavy metals often accumulate in roadside soils, primarily in organic soils (Bolan and Duraisamy 2003), and can contaminate ecosystems and groundwater used for human consumption if heavy metals become disassociated from soil materials (e.g., Norrström and Jacks 1998). The heavy metals that most commonly accumulate in habitats adjacent to roads include aluminum, boron, cadmium, copper, iron, lead, manganese, mercury, nickel, titanium, and zinc (Trombulak and Frissell 2000).

**Heavy-metal accumulation in soils.** Automobile traffic is responsible for the majority of these metals accumulating along roads, mostly because of vehicular degradation (e.g., rust), brake and tire wear, leaking fluids, and the legacy effects of lead used in gasoline (Amrhein et al. 1992, Bauske and Goetz 1993, Davis et al. 2001). However, in urban areas, sources such as the siding of buildings can contribute more metals than vehicles do, including lead, cadmium, and zinc (Davis et al. 2001). Studies reporting heavy-metal concentrations in soils along roads suggest that heavy-metal contamination varies by country, depending on the number of vehicles using the road, the time since road construction, and the types of soil along the road (e.g., Fakayode and Olu-Owolabi 2003, Saedi et al. 2009, Wei and Yang 2010). Although not all contaminated areas present toxic risks to humans and wildlife, heavy-metal contamination of roadside soils is a global problem. Despite metals flowing in runoff or blowing away from roadways, metal concentrations are typically highest within 10 meters of the paved surface and within the top 15 centimeters of soil along the road (Werkenthin et al. 2014). The accumulation or transport of heavy metals away from roads depends on the metal, road surface permeability, and climatic factors such as season and precipitation rates (Göbel et al. 2007, Li et al. 2007). The high concentration of metals surrounding paved roads indicates that the ecological and health threats should be most pronounced around densely traveled roads and in

densely populated areas, because larger and more heavily used roads typically have more contaminants (Fakayode and Olu-Owolabi 2003, Göbel et al. 2007).

**Heavy-metal fractionation and availability in soils.** Dozens of studies have quantified the total concentrations of heavy metals in soils along roads (reviewed by Werkenthin et al. 2014, Huber et al. 2016). Metals can be associated with soils in a variety of ways, including bioavailable species (e.g., free ions, easily exchangeable ions, or adsorbed ions) and poorly available species (e.g., refractory organic complexes or crystalline structures; Violante et al. 2010). However, the total metal content in soil is a poor indicator of the current and potential bioavailability, because metals can exist as various chemical types (i.e., species) in soil and have different potentials for transformation to bioavailable phases (Krishnamurti et al. 1995, Krishnamurti and Naidu 2002). For example, metals present in mineral structures in soil are typically not bioavailable but can be easily transformed by changes to soil chemistry (e.g., Campbell and Stokes 1985). Transformation to a bioavailable state includes changing metals from a mineral state to a soluble, adsorbed, or complexed state. The potential bioavailability depends on the type of metal in the soil, the concentration of free ions in the soil, the concentration of colloiddally bound heavy-metal complexes, and the type of soil (Carvalho et al. 1999, Brown and Markich 2000, Krishnamurti and Naidu 2002, Violante et al. 2010). In addition, the release or transformation of these heavy metals depends on numerous factors, such as the soil type, percentage of soil made up by colloids, pH, water saturation, amount of dissolved organic carbon, and the species of each metal present in the soil (Green et al. 2008). Once these metals become more bioavailable and disassociated from organic soil materials, they can be further transformed into dissolved ions, which are then more easily taken up by organisms (e.g., FIAM; Parker and Pedler 1997, Brown and Markich 2000, Campbell et al. 2002). Heavy metals that enter freshwater ecosystems can present numerous toxicological and ecological effects on organisms and ecosystem function.

**Heavy metals in freshwater systems.** Streams near roads are often contaminated by heavy metals, and the organisms in those streams can be subjected to the toxicological effects of heavy metals. Heavy metals from roadside materials (e.g., mercury, lead, cadmium, and copper) can reduce the diversity of macroinvertebrates, alter food-web structures, and reduce ecosystem services in streams (Maltby et al. 1995, Clements et al. 2000, Hirst et al. 2002, Carlisle and Clements 2005). Clements and colleagues (2000) showed that increased concentrations of a mixture of heavy metals (mostly lead, zinc, copper, and aluminum) reduced the number of organismal species in freshwater streams, and the concentrations of metals directly predicted the abundance of various organismal functional groups (e.g., grazers, scrapers, and predators). Higher metal concentrations led to a reduced number

of individuals for each group. In addition, the richness of mayflies, caddisflies, stoneflies, and chironomids were reduced when metal concentrations were high. In flowing waters, heavy-metal contamination (primarily copper and zinc) reduces litter breakdown rates and reduces microbial respiration (Carlisle and Clements 2005, Ferreira et al. 2016). Finally, heavy metals in streams can negatively affect microbial communities in streams. However, some evidence suggests that algae and diatoms are resilient to heavy-metal contamination (Hirst et al. 2002). Further investigations into the consequence of continued heavy-metal contamination on microbial processes in streams could elucidate the potential for long-term cascading effects that reduce ecosystem function and ecosystem services provided by streams.

Heavy metals accumulate in freshwater lakes and can have toxicological effects on organisms (e.g., Balistrieri et al. 1992, Wenchuan et al. 2001). However, few studies have investigated the effects of heavy metals on entire freshwater food webs (see Altındağ and Yiğit 2005). Field studies of freshwater lakes have mainly focused on the accumulation of heavy metals in single animal species, especially fish (e.g., Malik et al. 2010, Monroy et al. 2014). An important aspect missing from the research of heavy-metal effects in freshwater lakes is the effect they have on ecosystem services of benthic communities. In terrestrial soils, heavy metals can be toxic to microorganisms, thereby reducing ecosystem functions such as nutrient cycling and decomposition of organic materials (Kandeler et al. 1996, Giller et al. 1998, Peters et al. 2013). However, no investigations of heavy-metal toxicity on microbial activity in lake or pond benthic communities have occurred. Investigating the effects of heavy metals on aerobic and anaerobic processes in lakes and ponds would be beneficial to better understand how ecosystem services and ecosystem functions are disrupted in lake systems that vary in depth, soil type, and trophic state.

Wetlands can become toxic, heavy-metal sinks from roadside contamination. However, wetlands can also be used as bioremediation sites (through sludge removal and microbial activity) because of high amounts of organic materials in soils and the ability of microbes and some plant species to tolerate and accumulate high metal concentrations in their tissues (Spellerberg 1998). In addition, the abundant organic material in wetlands has a high binding affinity for heavy metals. However, anaerobic respiration in wetland soils could increase the rate of transformation of bound heavy-metal complexes into more easily mobilized species (e.g., iron and manganese; Kim and Koretsky 2013). One exception is mercury, which can be locked in species that are not bioavailable in anaerobic conditions (Mehrotra and Sedlak 2005). In addition, the abundance of metals such as nickel regulate processes affecting methane and other greenhouse gas production in wetland communities (e.g., Basiliko and Yavitt 2001), because ionic nickel is required for enzyme production in all methanogens (Rothman et al. 2014). Increased mobilization and increased bioavailability of heavy metals into wetlands could provide microbes with an

additional source of ionic nickel. This, along with increased temperatures, would positively affect the overall metabolic rate of these organisms, eventually leading to increased methane production. However, no studies have investigated this potential interaction. Further investigations into the complex effects that heavy metals have in wetlands will help researchers understand whether wetlands act as heavy-metal sinks or whether an increase in heavy metals will change ecosystems services in wetlands, potentially leading to an increased production of greenhouse gases.

Heavy metals enter groundwater through numerous anthropogenic activities, including mining, agriculture, landfills, and urban developments. The transport of roadside heavy metals to groundwater has been demonstrated through observational and experimental studies (Norrström and Jacks 1998, Walraven et al. 2014), although the proportion of heavy metals that enter groundwater because of roadside pollution relative to other forms of pollution is unknown. The increasing prevalence and concentration of heavy metals in groundwater should be alarming, because these metals threaten human health (e.g., lead) and their presence could go undetected for many years, especially in rural communities and in agricultural systems that are infrequently tested.

### Road deicers

Globally, road salts including sodium chloride (NaCl), magnesium chloride (MgCl<sub>2</sub>), and calcium chloride (CaCl<sub>2</sub>) are used as deicers on roadways to melt ice and snow and reduce vehicle accidents (Fay and Shi 2012). Sodium chloride is the most common road salt applied globally (more than 90%), but alternative salts are commonly used in many locations (Fay and Shi 2012). Nonchloride-based alternatives such as calcium magnesium acetate (CMA) and potassium acetate (KAc) are also used but in very small quantities (Fay and Shi 2012).

The quantity of most deicing salts used on roadways has dramatically increased around the world. For example, in 1950, less than 1 million tonnes of road salt (NaCl) was applied to roads in the United States. Road-salt applications increased to approximately 10 million tonnes by 1990 and nearly 20 million tonnes by 2014 (Bolen 2014). In addition, some European countries, such as Sweden and Denmark, have reported greater than 33% increases in NaCl application rates since the 1970s (e.g., Löfgren 2001).

This rapid surge in road-salt application has increased awareness about the potential ecological effects of salts (Corsi et al. 2010, Cañedo-Argüelles et al. 2016). These ecological effects include increased toxicity for organisms in roadside soil and nearby freshwater communities (Corsi et al. 2010). Probably the most widely observed effect near roads is the toxicity to roadside plants, whose leaves and needles turn brown because of a buildup up chloride, eventually leading to plant death (Devitt et al. 2014). In addition to toxic effects on plants, road salts degrade soil structure (e.g., weakening the binding of organic material

to mineral structures), alter soil chemistry (e.g., increasing pH), and increase ammonification through the displacement of  $H^+$  ions (Green et al. 2008). Increasing salt concentrations can also reduce microbial abundance and function and reduce the survival and species richness of soil invertebrates (Černohlávková et al. 2008, Ke et al. 2013).

Numerous laboratory studies have shown that road salts are highly toxic to individual species of aquatic organisms (Blasius and Merritt 2002, Linton et al. 2008, Gillis 2011, Tyree et al. 2016, Hintz and Relyea 2017). However, researchers have recently shifted from lab-based studies to experimental and observational studies of food webs and the ecosystem-level effects of salt in terrestrial and freshwater communities (e.g., Hintz et al. 2017, Schuler et al. 2017). The shift in focus from individual species to communities has indicated that the acute and chronic effects of salt in freshwater systems are more complex than laboratory-based toxicity tests indicate and can include shifts in the composition of aquatic organisms, trophic cascades, and effects on ecosystem services such as denitrification (e.g., Lancaster et al. 2016, Hintz et al. 2017, Schuler et al. 2017). In addition, these community-level effects can be observed at concentrations below the chronic (230 milligrams, mg,  $Cl^-$  per liter, L) and acute (860 mg  $Cl^-$  per L) thresholds established by the US Environmental Protection Agency (US EPA 1988).

Human health risks also exist because of the increase in road-salt application. Groundwater contamination from road salt has increased, with some municipalities reporting concentrations above the EPA secondary-drinking-water threshold of 250 mg  $Cl^-$  per L (Corsi et al. 2010). Chloride concentrations as high as 7730 mg per L have been recorded in contaminated freshwater systems in the United States (Corsi et al. 2010). Researchers from other countries have also reported toxic chloride concentrations. For example, researchers in Denmark have reported concentrations of chloride in soil water as high as 1400 mg  $Cl^-$  per L during winter (Pedersen et al. 1999), and researchers from Sweden have reported dramatic increases in soil and water chloride concentrations because of the increased application of road salts (Thunqvist 2004). Increased salinity in drinking water most often causes foul-tasting water, but is not generally toxic to humans, except for those with medical issues such as high blood pressure, heart failure, or some kidney diseases. The majority of threats to water used for human consumption does not come directly from the salt but instead comes from the chemicals associated with road salts and the effects that the increased salinization of drinking water has on lead pipes (Kaushal 2016, Stets et al. 2017).

### The mobilization and alteration of heavy metals by road salts

Heavy metals readily bind to organic roadside soils; however, road salts can release heavy metals that are associated with organic soils through several interrelated mechanisms (Amrhein and Strong 1990, Amrhein et al. 1992, Bauske and Goetz 1993, Löfgren 2001, Bäckström et al. 2004). Road salts

can increase the distribution and bioavailability of heavy metals by disrupting soil structure, changing soil chemistry, and altering ion exchange (Norrström and Jacks 1998, Norrström and Bergstedt 2001). Once mobilized, heavy metals and salts move from soil along roadways, potentially accumulating in freshwater ecosystems.

High concentrations of sodium can displace calcium and magnesium in the soil, thereby disrupting the structure of the soil, especially following large flows of low-electrolyte water (e.g., few dissolved ions) into sodium-rich soils (Amrhein et al. 1992, Norrström and Bergstedt 2001, Bäckström et al. 2004, Norrström 2005). This occurs when large quantities of salt are applied to roads to remove ice and snow and then a heavy rain event occurs, leading to low-electrolyte runoff. This disruption of soil structure leads to the increased porosity of the soil and increases the mobilization of metals and their associated compounds (Norrström and Jacks 1998). For example, Tang and Weisbrod (2009) showed that lead is more mobile when associated with colloidal structures in soil, which is likely because of the breakdown of colloidal structures and the disassociation of organic compounds caused by road salt (Norrström and Bergstedt 2001). This allows chloride complexes to form and mobilize heavy metals (e.g., lead) away from organic rich topsoils and into groundwater (Howard and Sova 1993, Bäckström et al. 2004). Heavy-metal mobilization by the complexation of chlorides depends on whether soils are organic or mineral based. In organic soils, aqueous ligand complexes will reduce the adsorption of some metals, such as cadmium, lead, zinc, and mercury, which increases the potential for mobilization by chloride complexes (Hahne and Kroontje 1973, Lumsdon et al. 1995). As metals are desorbed and transformed into a soluble phase, chloride complexes can increase the solubility of the metals, increasing their persistence in soil and freshwater ecosystems (Warren and Zimmerman 1994). The breakdown of surface-soil structure due to road salts is important for understanding the potential rate of mobility of heavy metals, because soils below the upper horizons typically have little organic material and are primarily mineral based. Once metals become disassociated from organic surface soils, they can move quickly into freshwater systems and can persist, associated with chloride complexes (Warren and Zimmerman 1994).

Finally, salts can directly displace metals without affecting soil structure or pH. The binding affinity of many organic compounds is higher for sodium, calcium, and magnesium than it is for most heavy metals (reviewed by Bäckström et al. 2004). High concentrations of cations from salts displace soil-bound metals such as cadmium, copper, and zinc (Granato et al. 1995, Bäckström et al. 2004). Soils with high concentrations of NaCl can result in high ionic strength, reducing the binding affinities of heavy metals to soils and increasing their potential mobility (Naidu et al. 1994, Norrström 2005). Although NaCl is the most commonly used road salt, other road salts (e.g.,  $MgCl_2$  and  $CaCl_2$ ) have a greater effect on heavy-metal mobilization through



ion displacement than NaCl (Acosta et al. 2011). Therefore, calcium and magnesium are more likely to mobilize metals because of ion exchange compared with sodium because of their higher exchangeability (i.e., higher binding affinity) in organic soils.

The majority of mobilization of heavy metals by salts is likely due to ion exchange rather than changes to soil structure or pH (Bäckström et al. 2004). However, the importance of ion exchange depends on the type of metal, the type of salt, soil structure, and soil composition. Cadmium, cobalt, and copper are more easily mobilized by ion exchange than lead and zinc are (Bäckström et al. 2004, Heier et al. 2013), but chromium is likely less mobilizable through ion exchange compared with other metals (Pagotto et al. 2001), possibly because of strong associations with iron and magnesium oxides in soil (Guo et al. 1997). Dozens of experimental and field investigations show that road salts increase the mobility of heavy metals through interrelated mechanisms. However, very little information exists on the mobility rates of heavy metals, the long-term trends of heavy metals in ground- and surface-water concentrations, the proportion of heavy metals that are bioavailable, and the rates of transformation from unavailable to bioavailable metals in roadside soils. Walraven and colleagues (2014) showed that after lead reached depths of 15 centimeters, it moved quickly (72–324 mg per square meter per year) into groundwater because of low soil pH and low amounts of organic material below those depths. Despite relatively low concentrations of lead in the groundwater, Walraven and colleagues (2014) demonstrated that 100% of the lead in the groundwater had anthropogenic origins. To understand the risks associated with heavy-metal contamination and road-salt use, more comprehensive studies are needed that trace the origins (e.g., anthropogenic or natural) of heavy metals in roadside soils and in freshwater ecosystems. Furthermore, these studies should investigate how road salts change the bioavailable fraction of heavy metals in roadside soils and whether road salts increase the rate that heavy metals move into freshwater ecosystems (relative to salt-free areas).

Nonchloride salt alternatives (e.g., CMA) also increase the mobilization of heavy metals in soil (Granato et al. 1995), but the mechanism of increased transport varies. CMA mobilization of heavy metals is more likely to occur through ligand complexation and with competitive exchange of ions (Amrhein et al. 1992). However, some evidence suggests that the overall effect of CMA on the mobilization of heavy metals is likely less effective than that of NaCl, with specific exceptions being cadmium and lead (Amrhein et al. 1992). Further research is needed to understand the underlying mechanisms explaining the mobilization differences among these salts.

Collectively, these studies suggest that road salts increase the rate of movement of heavy metals (relative to areas without road salt), alter the distribution of heavy metals in soils (figure 1), and affect the fractionation of bioavailable heavy metals in soil and in freshwater ecosystems.

Understanding the relative fractions of various metals in soils is important for calculating the mobility of heavy metals out of soil and into freshwater systems (e.g., streams, lakes, wetlands, and groundwater). Chemical reactions and chemical complexation of heavy metals with organic and inorganic soil components greatly affect the mobility, bioavailability, and therefore toxicity of heavy metals (reviewed in Violante et al. 2010). Quantifying the fractionation of heavy metals in soil can increase our understanding of the risks associated with the bioaccumulation of metals, which could threaten species diversity, ecosystem function, and ecosystem services in freshwater systems. Some researchers have investigated the fractionation of heavy metals in roadside soils and shown that road salts can increase the exchangeable fraction of metals (Howard and Sova 1993, Norrström and Jacks 1998). Cadmium typically has the highest exchangeable fraction, because it is commonly found in aqueous solutions and not adsorbed to soils (Norrström and Jacks 1998). Lead typically has a low exchangeable fraction because of strong associations with iron, magnesium oxides, and organic matter in soil. However, the application of road salts can alter soil chemistry (e.g., pH, ligands, and dissolved organic carbon), which could increase the exchangeable fraction of heavy metals such as lead (Clozel et al. 2006).

More information is needed to understand whether the accumulation of metals in food webs might be affected by the application of salts. Currently, there has not been a rigorous investigation of the precise mechanisms by which road salts affect soil chemistry and heavy-metal fractionation in soils (see Green et al. 2008). If salts increase the bioavailability of heavy metals and salts more easily mobilize the metals, then this could increase the toxic effects of heavy metals as they enter freshwater systems. For example, in soils of freshwater systems, cadmium and lead often have high percentages of easily transformed and bioavailable species compared with those of copper and chromium (Clozel et al. 2006). This is important, because lead is often shown to have a high organic-matter-bound fraction in soils, which means that the application of road salts could be mobilizing lead and increasing its bioavailability, thereby increasing the risk of bioaccumulation in freshwater systems.

### **The potential effects of heavy metals and salts on aquatic communities**

Freshwater ecosystems provide numerous ecosystem services, including clean drinking water, food resources, recreational benefits, and economic benefits (Dudgeon et al. 2006). Most research efforts have focused on the effects of single contaminants on individual species or a small group of species. However, studying the toxicological and ecological consequences of multiple contaminants at the community and ecosystem levels will improve our understanding of the threats that freshwater systems face, especially because many of those threats could have consequences for human health.

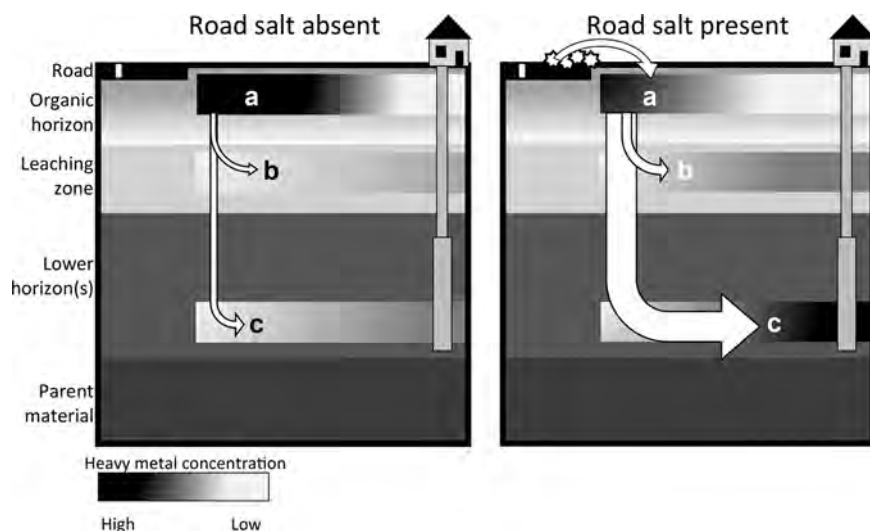

**Figure 1.** A depiction of the effects of road salt on heavy metal transport in soil along roads near homes or agriculture. (a) Heavy metals accumulate along a gradient (black and gray gradient bar), decreasing with distance from roads. The addition of road salt leads to fewer heavy metals being present in the organic layer at the surface because of rapid downward movement through the soil, indicated by the heavier arrows. (b) Heavy metals become disassociated from organic materials in the upper horizons, moving into leachate zones where they might enter freshwater systems (e.g., streams, lakes, and wetlands). (c) The presence of road salt might also increase the rate of movement across the leachate zones into groundwater. Collectively, these processes move heavy metals down into groundwater and slowly move horizontally, where they can enter wells and aquifers used for human consumption and agriculture.

Road salts and heavy metals are toxic to freshwater organisms, but there is very little information on their combined toxicological effects. One study on salmon (*Salmo salar*) egg development showed that the toxic effects of heavy metals and road salts together were more severe than the effects of each alone (Mahrosh et al. 2014). However, a related study on the alevin stage of *S. salar* showed that the toxic effects of salt were strongest, regardless of heavy-metal concentrations (Mahrosh et al. 2017). These contrasting results highlight the need for continued rigorous investigations of how contaminants interact to affect organisms, especially invertebrates that might be more susceptible to multiple contaminants or stressors compared with vertebrates.

Heavy metals are more toxic to macroinvertebrates than to fish; they reduce macroinvertebrate diversity, alter ecosystem services, and affect food-web structure of macroinvertebrate communities (Maltby et al. 1995, Clements et al. 2000, Hirst et al. 2002, Carlisle and Clements 2005). In addition, road salts are far more toxic to invertebrates and microbial communities than to fishes (Blasius and Merritt 2002, Linton et al. 2008, Gillis 2011, Tyree et al. 2016, Hintz and Relyea 2017). Comprehensive field and lab studies investigating the potential interactive effects of heavy metals and salts on freshwater communities will provide insights into the potential effects that multiple toxins might have on organismal diversity, ecosystem function, and ecosystem services. For

example, a greater focus on the potential effects of heavy metals and salts on mollusks, especially bivalves, will potentially show that the two contaminants are contributing to the rapid decline in bivalve diversity around the world, because they are very sensitive to salts and are known to accumulate heavy metals.

To our knowledge, no studies have investigated whether road salts increase the rate of accumulation of heavy metals in freshwater food webs. Road salts can increase the bioavailability and ionic presence of heavy metals in soils, which would then likely lead to the metals accumulating faster in plants and consumers, especially filter-feeding organisms such as bivalves. Even if the organisms can uptake high concentrations of heavy metals into tissue storage without dying (e.g., *Betula spp.* and *Salix spp.*; Gallagher et al. 2008), the presence of heavy metals might make them more susceptible to the toxic effects of road salt. As an example, multiple stressors (e.g., predation, pesticides, and fertilizers) negatively affect amphibian populations (Boone et al. 2007). Although organisms might be able to tolerate a single stressor, changes in predation pressure, competition, or climate warming

might alter the way that these stressors affect populations and communities (e.g., O’Gorman et al. 2012). Furthermore, multiple contaminants might only affect a few organisms, but the absence of these organisms in the food web can have a cascading effect, leading to ecosystem consequences (Relyea 2005). It is also paramount that researchers maintain a focus on field investigations, because the toxicity and effects of these contaminants found from lab studies do not directly transfer to natural systems (Giller et al. 1998).

We also suggest that future research efforts focus on ecosystem functions and ecosystem services. Toxicological and ecological studies at the organismal level might underestimate the long-term consequences of multiple contaminants, such as heavy metals and road salts accumulating in aquatic systems. As an example, many shallow wetlands and ponds might be metal limited, which is important because the abundance of metals such as nickel regulate processes affecting methane and other greenhouse-gas production (e.g., Basiliko and Yavitt 2001). The limited quantity of ionic nickel in wetlands is important, because the methane cycle requires ionic nickel (Krüger et al. 2006). Increased mobilization and increased bioavailability of heavy metals such as nickel that are important for biogeochemical cycles in wetlands and shallow aquatic communities could increase microbial activity, magnifying the production of greenhouse gases and exacerbating the effects of climate change.



Finally, we suggest that future studies investigate the mobilization trends in heavy metals (e.g., lead) that could eventually become concentrated in groundwater used for human consumption and agriculture. Norrström and Jacks (1998) suggested that the increased mobilization of lead due to road-salt pollution increased the concentrations of lead in wells near roads. Walraven and colleagues (2014) demonstrated that lead quickly moves into groundwater after being released from soil by road salt. Therefore, further research on the transport of metals such as lead could help in the development of predictive models for understanding areas of high risk, such as areas that have shallow groundwater and large roadways in states that apply large quantities of road salts per lane kilometer. These models would be especially useful in rural areas that do not rely on city water systems and farmlands, which could be more easily monitored. Modeling the potential mobilization of lead into drinking water, given the amount of traffic (i.e., concentrations of metals), the amount of road-salt use, and soil structure, could inform landowners and farmers about the potential risks associated with using groundwater. It is also important for urban communities to monitor increasing concentrations of salts in water used for human consumption because of the potential for salts to mobilize heavy metals into drinking water and to release toxic levels of lead from pipes (Kaushal 2016).

### Conclusions

Vehicular use along roadways has increased the concentrations of heavy metals in soils. In addition, salts used for deicing roads mobilize heavy metals, transporting them away from roadways, deeper into soil, and eventually into freshwater ecosystems. The rapid increase in road-salt use over the last two decades could mean that more heavy metals are being transported away from roads and into freshwater systems. Heavy metals and road salts accumulate in freshwater ecosystems, and both have been shown to be individually toxic to freshwater organisms and to affect ecosystem function and ecosystem services. However, there has been a great lack of research on the potential interactive effects of road salts and heavy metals. With this article, we hope to inspire more research on the interactive effects of road salts and heavy metals. These interactive effects include the direct effects that salts have on the bioavailability, mobility, and transport rate of heavy metals; the toxicological effects that metals and salts have on organisms and communities; and the ecosystem effects that these contaminants might have. We also urge increased focus on the potential contamination of groundwater sources used for human consumption and farming. Increased field research and modeling efforts will be vital for estimating the potential effects that these contaminants will have with increased vehicular use and road-salt application.

### Acknowledgments

Research funding was provided by The Jefferson Project at Lake George, which is a collaboration of Rensselaer

Polytechnic Institute, IBM, and The FUND for Lake George. We also appreciate the helpful comments and suggestions from the three anonymous reviewers. Their feedback greatly improved this manuscript.

### References cited

- Acosta JA, Jansen B, Kalbitz K, Faz A, Martínez-Martínez S. 2011. Salinity increases mobility of heavy metals in soils. *Chemosphere* 85: 1318–1324.
- Altındağ A, Yiğit S. 2005. Assessment of heavy metal concentrations in the food web of lake Beyşehir, Turkey. *Chemosphere* 60: 552–556.
- Amrhein C, Strong JE. 1990. The effect of deicing salts on trace metal mobility in roadside soils. *Journal of Environmental Quality* 19: 765–772.
- Amrhein C, Strong JE, Mosher PA. 1992. Effect of deicing salts on metal and organic matter mobilization in roadside soils. *Environmental Science and Technology* 26: 703–709.
- Bäckström M, Karlsson S, Bäckman L, Folkesson L, Lind B. 2004. Mobilisation of heavy metals by deicing salts in a roadside environment. *Water Research* 38: 720–732.
- Balistrieri LS, Murray JW, Paul B. 1992. The cycling of iron and manganese in the water column of Lake Sammamish, Washington. *Limnology and Oceanography* 37: 510–528.
- Basiliko N, Yavitt JB. 2001. Influence of Ni, Co, Fe, and Na additions on methane production in Sphagnum-dominated Northern American peatlands. *Biogeochemistry* 52: 133–153.
- Bauske B, Goetz D. 1993. Effects of deicing salts on heavy metal mobility. *Acta Hydrochimica et Hydrobiologica* 21: 38–42.
- Blasius BJ, Merritt RW. 2002. Field and laboratory investigations on the effects of road salt (NaCl) on stream macroinvertebrate communities. *Environmental Pollution* 120: 219–231.
- Bolan NS, Duraisamy VP. 2003. Role of inorganic and organic soil amendments on immobilisation and phytoavailability of heavy metals: A review involving specific case studies. *Soil Research* 41: 533–555.
- Bolen WP. 2014. Salt. US Geological Survey Minerals Yearbook. US Geological Survey. 30 January 2018; <https://minerals.usgs.gov/minerals/pubs/commodity/salt>
- Boone MD, Semlitsch RD, Little EE, Doyle MC. 2007. Multiple stressors in amphibian communities: Effects of chemical contamination, bullfrogs, and fish. *Ecological Applications* 17: 291–301.
- Boving TB, Stolt MH, Augenstern J, Brosnan B. 2008. Potential for localized groundwater contamination in a porous pavement parking lot setting in Rhode Island. *Environmental Geology* 55: 571–582.
- Brown PL, Markich SJ. 2000. Evaluation of the free ion activity model of metal-organism interaction: Extension of the conceptual model. *Aquatic Toxicology* 51: 177–194.
- Campbell PGC, Stokes PM. 1985. Acidification and toxicity of metals to aquatic biota. *Canadian Journal of Fisheries and Aquatic Sciences* 42: 2034–2049.
- Campbell PG, Errécalde O, Fortin C, Hiriart-Baer VP, Vigneault B. 2002. Metal bioavailability to phytoplankton: Applicability of the biotic ligand model. *Comparative Biochemistry and Physiology Part C: Toxicology and Pharmacology* 133: 189–206.
- Cañedo-Argüelles M, et al. 2016. Saving freshwater from salts. *Science* 351: 914–916.
- Carlisle DM, Clements WH. 2005. Leaf litter breakdown, microbial respiration and shredder production in metal-polluted streams. *Freshwater Biology* 50: 380–390.
- Carvalho RA, Benfield MC, Santschi PH. 1999. Comparative bioaccumulation studies of colloidal complexed and free-ionic heavy metals in juvenile brown shrimp *Penaeus aztecus* (Crustacea: Decapoda: Penaeidae). *Limnology and Oceanography* 44: 403–414.
- Černohlávková J, Hofman J, Bartoš T, Sáňka M, Anděl P. 2008. Effects of road deicing salts on soil microorganisms. *Plant Soil Environment* 54: 479–485.
- Clements WH, Carlisle DM, Lazorchak JM, Johnson PC. 2000. Heavy metals structure benthic communities in Colorado mountain streams. *Ecological Applications* 10: 626–638.

- Clozel B, Ruban V, Durand C, Conil P. 2006. Origin and mobility of heavy metals in contaminated sediments from retention and infiltration ponds. *Applied Geochemistry* 21: 1781–1798.
- Corsi SR, Graczyk DJ, Geis SW, Booth NL, Richards KD. 2010. A fresh look at road salt: Aquatic toxicity and water-quality impacts on local, regional, and national scales. *Environmental Science and Technology* 44: 7376–7382.
- Davis AP, Shokouhian M, Ni S. 2001. Loading estimates of lead, copper, cadmium, and zinc in urban runoff from specific sources. *Chemosphere* 44: 997–1009.
- Devitt DA, Wright L, Landau F, Apodaca L. 2014. Deicing salts: Assessing distribution, ion accumulation in plants and the response of plants to different loading rates and salt mixtures. *Environment and Natural Resources Research* 4: 73–93.
- Dudgeon D, et al. 2006. Freshwater biodiversity: Importance, threats, status and conservation challenges. *Biological Reviews* 81: 163–182.
- Fakayode SO, Olu-Owolabi BI. 2003. Heavy metal contamination of roadside topsoil in Osogbo, Nigeria: Its relationship to traffic density and proximity to highways. *Environmental Geology* 44: 150–157.
- Fay L, Shi X. 2012. Environmental impacts of chemicals for snow and ice control: State of the knowledge. *Water, Air, and Soil Pollution* 223: 2751–2770.
- Ferreira V, Koricheva J, Duarte S, Niyogi DK, Guérol F. 2016. Effects of anthropogenic heavy metal contamination on litter decomposition in streams: A meta-analysis. *Environmental Pollution* 210: 261–270.
- Forman RT, Alexander LE. 1998. Roads and their major ecological effects. *Annual Review of Ecology and Systematics* 29: 207–231.
- Gallagher FJ, Pechmann I, Bogden JD, Grabosky J, Weis P. 2008. Soil metal concentrations and vegetative assemblage structure in an urban brown-field. *Environmental Pollution* 153: 351–361.
- Giller KE, Witter E, Mcgrath SP. 1998. Toxicity of heavy metals to microorganisms and microbial processes in agricultural soils: A review. *Soil Biology and Biochemistry* 30: 1389–1414.
- Gillis PL. 2011. Assessing the toxicity of sodium chloride to the glochidia of freshwater mussels: Implications for salinization of surface waters. *Environmental Pollution* 159: 1702–1708.
- Göbel P, Dierkes C, Coldewey WG. 2007. Storm water runoff concentration matrix for urban areas. *Journal of Contaminant Hydrology* 91: 26–42.
- Granato GE, Church PE, Stone VJ. 1995. Mobilization of major and trace constituents of highway runoff in groundwater potentially caused by deicing chemical migration. *Transportation Research Record* 1483: 92–104.
- Green S.M, Machin R, Cresser, M.S. 2008. Effect of long-term changes in soil chemistry induced by road salt applications on N-transformations in roadside soils. *Environmental Pollution* 152: 20–31.
- Guo T, DeLaune RD, Patrick WH. 1997. The influence of sediment redox chemistry on chemically active forms of arsenic, cadmium, chromium, and zinc in estuarine sediment. *Environment International* 23: 305–316.
- Hahne HCH, Kroontje W. 1973. Significance of pH and chloride concentration on behavior of heavy metal pollutants: Mercury (II), cadmium (II), zinc (II), and lead (II). *Journal of Environmental Quality* 2: 444–450.
- Heier LS, Nyheim MT, Skipperud L, Meland S. 2013. Mobility and uptake of antimony, cadmium and cobalt in dragonfly larvae (Odonata, Anisoptera) as a function of road salt concentrations: A tracer experiment. Pages 507–516 in Rauch S, Morrison G, Norra S, Schleicher N, eds. *Urban Environment: Proceedings of the 11th Environment Symposium*. Springer.
- Hintz WD, Relyea RA. 2017. Impacts of road deicing salts on the early-life growth and development of a stream salmonid: Salt type matters. *Environmental Pollution* 223: 409–415.
- Hintz WD, Mattes BM, Schuler MS, Jones DK, Stoler AB, Lind L, Relyea RA. 2017. Salinization triggers a trophic cascade in experimental freshwater communities with varying food-chain length. *Ecological Applications* 27: 833–844.
- Hirst H, Jüttner I, Ormerod SJ. 2002. Comparing the responses of diatoms and macro-invertebrates to metals in upland streams of Wales and Cornwall. *Freshwater Biology* 47: 1752–1765.
- Howard JL, Sova JE. 1993. Sequential extraction analysis of lead in Michigan roadside soils: Mobilization in the vadose zone by deicing salts? *Soil and Sediment Contamination* 2: 361–378.
- Huber M, Welker A, Helmreich B. 2016. Critical review of heavy metal pollution of traffic area runoff: Occurrence, influencing factors, and partitioning. *Science of The Total Environment* 541: 895–919.
- Kandeler F, Kampichler C, Horak O. 1996. Influence of heavy metals on the functional diversity of soil microbial communities. *Biology and Fertility of Soils* 23: 299–306.
- Kaushal SS. 2016. Increased salinization decreases safe drinking water. *Environmental Science and Technology* 50: 2765–2766.
- Ke C, Li Z, Liang Y, Tao W, Du M. 2013. Impacts of chloride de-icing salt on bulk soils, fungi, and bacterial populations surrounding the plant rhizosphere. *Applied Soil Ecology* 72: 69–78.
- Kim SY, Koretsky C. 2013. Effects of road salt deicers on sediment biogeochemistry. *Biogeochemistry* 112: 343–358.
- Krishnamurti GS, Naidu R. 2002. Solid–solution speciation and phytoavailability of copper and zinc in soils. *Environmental Science and Technology* 36: 2645–2651.
- Krishnamurti GSR, Huang PM, Van Rees KCJ, Kozak LM, Rostad HPW. 1995. Speciation of particulate-bound cadmium of soils and its bioavailability. *Analyst* 120: 659–665.
- Krüger M, et al. 2003. A conspicuous nickel protein in microbial mats that oxidize methane anaerobically. *Nature* 426: 878–881.
- Lancaster NA, Bushey JT, Tobias CR, Song B, Vadas TM. 2016. Impact of chloride on denitrification potential in roadside wetlands. *Environmental Pollution* 212: 216–223.
- Li FR, Kang LF, Gao XQ, Hua W, Yang FW, Hei WL. 2007. Traffic-related heavy metal accumulation in soils and plants in northwest China. *Soil and Sediment Contamination* 16: 473–484.
- Linton TK, Tarr CD, Rickramanayake N, Soucek DJ, Dickinson A. 2008. Acute Toxicity of Chloride to Select Freshwater Invertebrates. Great Lakes Environmental Center. (16 July 2017; [www.fwspubs.org/doi/suppl/10.3996/052013-JFWM-033/suppl\\_file/patnodereference+s5.pdf](http://www.fwspubs.org/doi/suppl/10.3996/052013-JFWM-033/suppl_file/patnodereference+s5.pdf))
- Löfgren S. 2001. The chemical effects of deicing salt on soil and stream water of five catchments in southeast Sweden. *Water, Air, and Soil Pollution* 130: 863–868.
- Lumsdon DG, Evans LJ, Bolton KA. 1995. The influence of pH and chloride on the retention of cadmium, lead, mercury, and zinc by soils. *Soil and Sediment Contamination* 4: 137–150.
- Mahrosh U, Kleiven M, Meland S, Rosseland BO, Salbu B, Teien HC. 2014. Toxicity of road deicing salt (NaCl) and copper (Cu) to fertilization and early developmental stages of Atlantic salmon (*Salmo salar*). *Journal of Hazardous Materials* 280: 331–339.
- Malik N, Biswas AK, Qureshi TA, Borana K, Virha R. 2010. Bioaccumulation of heavy metals in fish tissues of a freshwater lake of Bhopal. *Environmental Monitoring and Assessment* 160: 267–276.
- Maltby L, Forrow DM, Boxall A, Calow P, Betton CI. 1995. The effects of motorway runoff on freshwater ecosystems: 1. Field study. *Environmental Toxicology and Chemistry* 14: 1079–1092.
- Mehrotra AS, Sedlak DL. 2005. Decrease in net mercury methylation rates following iron amendment to anoxic wetland sediment slurries. *Environmental Science and Technology* 39: 2564–2570.
- Monroy M, Maceda-Veiga A, de Sostoa A. 2014. Metal concentration in water, sediment and four fish species from Lake Titicaca reveals a large-scale environmental concern. *Science of the Total Environment* 487: 233–244.
- Naidu R, Bolan NS, Kookana RS, Tiller KG. 1994. Ionic-strength and pH effects on the sorption of cadmium and the surface charge of soils. *European Journal of Soil Science* 45: 419–429.
- Norrström AC. 2005. Metal mobility by de-icing salt from an infiltration trench for highway runoff. *Applied Geochemistry* 20: 1907–1919.
- Norrström AC, Bergstedt E. 2001. The impact of road de-icing salts (NaCl) on colloid dispersion and base cation pools in roadside soils. *Water, Air, and Soil Pollution* 127: 281–299.

- Norrström AC, Jacks G. 1998. Concentration and fractionation of heavy metals in roadside soils receiving de-icing salts. *Science of the Total Environment* 218: 161–174.
- O’Gorman EJ, Fitch JE, Crowe TP. 2012. Multiple anthropogenic stressors and the structural properties of food webs. *Ecology* 93: 441–448.
- Pagotto C, Remy N, Legret M, Le Cloirec P. 2001. Heavy metal pollution of road dust and roadside soil near a major rural highway. *Environmental Technology* 22: 307–319.
- Parker DR, Pedler JF. 1997. Reevaluating the free-ion activity model of trace metal availability to higher plants. *Plant and Soil* 196: 223–228.
- Parker DR, Chaney RL, Norvell WA. 1995. Chemical equilibrium models: Applications to plant nutrition research. Pages 163–200 in Loeppert RH, Schwab AP, Goldberg S, eds. *Chemical Equilibrium and Reaction Models*. Soil Science Society of America (SSSA), American Society of Agronomy. SSSA Special Publication no. 42.
- Pedersen LB, Randrup TB, Ingerslev M. 2000. Effects of road distance and protective measures on deicing NaCl deposition and soil solution chemistry in planted median strips. *Journal of Arboriculture* 26: 238–245.
- Peters K, Bundschuh M, Schäfer RB. 2013. Review on the effects of toxicants on freshwater ecosystem functions. *Environmental Pollution* 180: 324–329.
- Relyea RA. 2005. The impact of insecticides and herbicides on the biodiversity and productivity of aquatic communities. *Ecological Applications* 15: 618–627.
- Rothman DH, Fournier GP, French KL, Alm EJ, Boyle EA, Cao C, Summons RE. 2014. Methanogenic burst in the end-Permian carbon cycle. *Proceedings of the National Academy of Sciences* 111: 5462–5467.
- Saeedi M, Hosseinzadeh M, Jamshidi A, Pajooheshfar SP. 2009. Assessment of heavy metals contamination and leaching characteristics in highway side soils, Iran. *Environmental Monitoring and Assessment* 151: 231–241.
- Schuler MS, Hintz WD, Jones DK, Lind LA, Mattes BM, Stoler AB, Sudol KA, Relyea RA. 2017. How common road salts and organic additives alter freshwater food webs: In search of safer alternatives. *Journal of Applied Ecology* 54: 1353–1361. doi:10.1111/1365-2664.12877
- Spellerberg I. 1998. Ecological effects of roads and traffic: A literature review. *Global Ecology and Biogeography Letters* 7: 317–333.
- Stets EG, Lee CJ, Lytle DA, Schock MR. 2018. Increasing chloride in rivers of the conterminous US and linkages to potential corrosivity and lead action level exceedances in drinking water. *Science of the Total Environment* 613: 1498–1509.
- Tang XY, Weisbrod N. 2009. Colloid-facilitated transport of lead in natural discrete fractures. *Environmental Pollution* 157: 2266–2274.
- Thunqvist EL. 2004. Regional increase of mean chloride concentration in water due to the application of deicing salt. *Science of the Total Environment* 325: 29–37.
- Trombulak SC, Frissell CA. 2000. Review of ecological effects of roads on terrestrial and aquatic communities. *Conservation Biology* 14: 18–30.
- Tyree M, Clay N, Polaskey S, Entrekkin S. 2016. Salt in our streams: Even small sodium additions can have negative effects on detritivores. *Hydrobiologia* 775:109–122.
- [US EPA] US Environmental Protection Agency. 1988. *Ambient Water Quality Criteria for Chloride*. US EPA.
- Violante A, Cozzolino V, Perelomov L, Caporale AG, Pigna M. 2010. Mobility and bioavailability of heavy metals and metalloids in soil environments. *Journal of Soil Science and Plant Nutrition* 10: 268–292.
- Walraven N, Van Os BJH, Klaver GT, Middelburg JJ, Davies GR. 2014. The lead (Pb) isotope signature, behaviour and fate of traffic-related lead pollution in roadside soils in The Netherlands. *Science of the Total Environment* 472: 888–900.
- Warren LA, Zimmerman AP. 1994. The influence of temperature and NaCl on cadmium, copper and zinc partitioning among suspended particulate and dissolved phases in an urban river. *Water Research* 28: 1921–1931.
- Wei B, Yang L. 2010. A review of heavy metal contaminations in urban soils, urban road dusts and agricultural soils from China. *Microchemical Journal* 94: 99–107.
- Wenchuan Q, Dickman M, Sumin W. 2001. Multivariate analysis of heavy metal and nutrient concentrations in sediments of Taihu Lake, China. *Hydrobiologia* 450: 83–89.
- Werkenthin M, Kluge B, Wessolek G. 2014. Metals in European roadside soils and soil solution: A review. *Environmental Pollution* 189: 98–110.

---

*Matthew S. Schuler (matt.s.schuler@gmail.com) and Rick A. Relyea are affiliated with the Department of Biological Sciences at the Darrin Fresh Water Institute of the Rensselaer Polytechnic Institute, in Troy, New York.*

# **EXHIBIT 23**

**BEFORE THE ILLINOIS POLLUTION CONTROL BOARD**

<b>IN THE MATTER OF:</b>	)	
	)	
<b>Petition of Midwest Generation</b>	)	
<b>for an Adjusted Standard from 845.740(a)</b>	)	
<b>and Finding of Inapplicability of Part 845</b>	)	<b>AS 2021-001</b>
<b>(Joliet 29)</b>	)	
	)	
	)	
<b>Respondents.</b>	)	

**AFFIDAVIT OF RICHARD GNAT**

I, Richard Gnat, being first duly sworn on oath, depose and state as follows:

1. I am over the age of 18 years and am a resident of Wisconsin.
2. The information in this Affidavit is based on my personal knowledge or belief in my capacity as a Professional Geologist with the State of Illinois and Principal of the environmental consulting firm KPRG and Associates, Inc. (KPRG), of which I am also part owner. KPRG has served as an environmental consultant to Midwest Generation, LLC (MWG) since 2005 regarding the remediation and/or management of various coal combustion residual (CCR) and coal combustion by-product (CCB) issues, including at Joliet 29 Station, and I would testify to such matters if called as a witness.
3. Since approximately 2013, KPRG has on a quarterly basis collected groundwater samples at the eleven monitoring wells at Joliet 29 pursuant to the requirements of a Compliance Commitment Agreement (CCA) MWG entered into with the Illinois Environmental Protection Agency in 2010 (the "CCA sampling"). For the CCA sampling, MWG collects samples for dissolved metals analysis, which requires groundwater samples to be field filtered.

4. From October 2015 through present, KPRG has also collected quarterly groundwater samples MW-3, MW-4, MW-5, and MW-10 at the Joliet 29 Station pursuant to 40 CFR Part 257 (“Federal CCR Rule”).

5. In April 2021, the Illinois rule regulating CCR (35 Ill. Adm. Code Part 845, the “Illinois CCR Rule”) became effective, which also requires collecting quarterly groundwater samples to assess compliance with new groundwater protection standards in 35 Ill. Adm. Code §845.600.

6. Under both the Federal CCR Rule and the Illinois CCR Rule, the groundwater sampling procedures under Part 845 require total recoverable metals concentrations in measuring groundwater quality, which means the groundwater samples are not field filtered. 40 CFR 257.93(h)(2)(i); 35 Ill. Adm. Code §845.640(i).

7. At Joliet 29 Station, KPRG takes two separate groundwater samples from wells MW-3, MW-4, MW-5, and MW-10, one for the CCA sampling and one for the Federal and Illinois CCR Rules. Samples are placed into various laboratory prepared contained depending on the analysis required. The CCR total metals analysis for antimony, arsenic, barium, beryllium, boron, cadmium, calcium, chromium, cobalt, lead, molybdenum, selenium and thallium are all derived from the same sample container. There are no separate or individual sample containers for these parameters. Other than the field filtering, there is no other difference between the groundwater sampling for the CCA or the CCR Rules.

8. For the quarterly groundwater sampling events that occurred at Joliet 29 Station on May and August 2021, KPRG followed all appropriate QA/QC procedures, and documented the chain-of-custody of each sample.

9. I have reviewed the laboratory documentation which accompanies both sets of the May 2021 and August 2021 samples. I did note that the chain-of-custody for the August 2021 CCR

sampling has a designation that the samples were field filtered. Mark Wilson of KPRG collected those samples. Mr. Wilson coordinates all the landfill sampling for one of KPRG's landfill clients and normally was not performing CCR sampling. I contacted Mr. Wilson and asked him about the field sampling procedures that he followed. He indicated that he knows he did not field filter these samples with the exception of the Total Dissolved Solids (TDS) sample which is a separate sample container from the total metals analysis. All other sample containers were not field filtered, including the container for the above noted metals analysis. The discussion below provides further evidence that the CCR metals samples in question were not field filtered and provide representative data.

10. I have performed a side-by-side comparison of reported total and dissolved results for the list of metals compounds noted in paragraph 7 above for data from monitoring wells MW-10, MW-3, MW-4 and MW-5 for the August 2021 sampling event. Only cobalt from the August 2021 sampling at well location MW-4 had a dissolved concentration slightly higher than the total metal concentration (dissolved cobalt at 0.0055 mg/l and a total cobalt at 0.0034 mg/l). All other total metals concentrations were either equal to or higher than the dissolved metals concentrations for the various noted parameters which is what would generally be expected between dissolved and total metals samples. The most compelling observation that further documents that the CCR samples was not field filtered is the arsenic data. In the sampling round in question, the dissolved arsenic concentration at all four monitoring well locations was non-detect with a detection limit of 0.001 mg/l. The CCR samples from those wells all had trace arsenic detections ranging from 0.0012 to 0.0018 mg/l as total metals concentration. The noted arsenic in the total metals analysis is therefore associated with sediment within that sample and when that sediment was filtered out



for the dissolved metals analysis the results were non-detect. As previously noted, the arsenic analysis is from the same sample container as the cobalt analysis.

11. Based on the above discussions, the noted slight disparity in total versus dissolved cobalt data from well MW-4 during the August 2021 sampling appears to be a slight statistical anomaly and not the result of improper field collection procedures. In my experience, such slight anomalies are not uncommon in large environmental datasets and when they occur, they should be evaluated in context of the larger overall dataset. The noted cobalt concentrations, both dissolved and total at well MW-4, are consistent with historical data from this location.

Under penalties as provided by law pursuant to Section 1-109 of the Code of Civil Procedure, the undersigned certifies that the statements set forth in this instrument are true and correct, except as to matters therein stated to be on information and belief and as to such matters the undersigned certifies as aforesaid that he verily believes the same to be true.

FURTHER AFFIANT SAYETH NOT.

Richard R. Jnes

Subscribed and Sworn to before me  
On March 18<sup>th</sup>, 2022.

Marina Trudell  
Notary Public

My Commission Expires: 01/25/2026

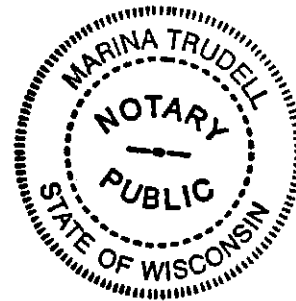

# **EXHIBIT 24**

**BEFORE THE ILLINOIS POLLUTION CONTROL BOARD**

<b>IN THE MATTER OF:</b>	)	
	)	
<b>Petition of Midwest Generation</b>	)	
<b>for an Adjusted Standard from 845.740(a)</b>	)	
<b>and Finding of Inapplicability of Part 845</b>	)	<b>AS 2021-001</b>
<b>(Joliet 29)</b>	)	
	)	
	)	
<b>Respondents.</b>	)	

**AFFIDAVIT OF MARK WILSON**

I, Mark Wilson, being first duly sworn on oath, depose and state as follows:

1. I am over the age of 18 years and am a resident of Illinois.
2. The information in this Affidavit is based on my personal knowledge or belief in my capacity as a Project Engineer with the environmental consulting firm KPRG and Associates, Inc. (KPRG). As a Project Engineer, I conduct environmental consultant services including collecting groundwater samples, and I would testify to such matters if called as a witness.
3. On August 30, 2021, I collected the groundwater samples from the groundwater wells at the Midwest Generation LLC (“MWG”) Joliet 29 Station.
4. I collected the groundwater from wells MW-3, MW-4, MW-5, and MW-10 for the Compliance Commitment Agreement (CCA) MWG entered into with the Illinois Environmental Protection Agency (the “CCA sampling”). For the CCA sampling, I collected the samples for dissolved metals analysis, which requires groundwater samples to be field filtered.
5. I also collected the groundwater from wells MW-3, MW-4, MW-5, and MW-10 pursuant to the Federal CCR Rule and the Illinois CCR Rule, which the groundwater sampling procedures under Part 845 require total recoverable metals concentrations in measuring groundwater quality, which means the groundwater samples are not field filtered. 40 CFR 257.93(h)(2)(i); 35 Ill. Adm.

Code §845.640(i). The CCR total metals analysis for antimony, arsenic, barium, beryllium, boron, cadmium, calcium, chromium, cobalt, lead, molybdenum, selenium and thallium are all derived from the same sample container. There are no separate or individual sample containers for these parameters.

6. I placed the groundwater samples into various laboratory prepared contained depending on the analysis required. Other than the field filtering, there is no other difference between the groundwater sampling for the CCA or the CCR Rules.

7. When I collected the CCR groundwater samples, I field filtered only the sample for Total Dissolved Solids. This sample is placed into a separate sample container from the above noted metals parameters. The field filtering designation on the chain-of-custody for these samples was to let the laboratory know that the TDS sample was already filtered and that they did not need to filter it again in the lab as part of the analytical protocol for TDS. I did not field filter the CCR samples for the total metals analysis.

Under penalties as provided by law pursuant to Section 1-109 of the Code of Civil Procedure, the undersigned certifies that the statements set forth in this instrument are true and correct, except as to matters therein stated to be on information and belief and as to such matters the undersigned certifies as aforesaid that he verily believes the same to be true.

FURTHER AFFIANT SAYETH NOT.

Mark Wilson

Subscribed and Sworn to before me  
On 3/15, 2022.

Kelly A Spadoni  
Notary Public

My Commission Expires: 8/21/24



# **EXHIBIT 25**



Exponent  
149 Commonwealth Drive  
Menlo Park, CA 94025

telephone 650-326-9400  
www.exponent.com

March 21, 2022

Subject: Midwest Generation v. Illinois EPA  
Exponent Project No. 2201894.000

Exponent, Inc. (Exponent) was retained to address selected statements regarding the Poz-o-pac material made by the Illinois Environmental Protection Agency (Illinois EPA) in the Recommendation of the Illinois Environmental Protection Agency, dated February 4, 2022.<sup>1</sup> Specifically, Exponent's scope was to address the following Illinois EPA statements: "*MWG's poz-o-pac is CCR<sup>2</sup> material*"<sup>3</sup> and "*the poz-o-pac... [is] CCR or CCR combined with other materials...*"<sup>4</sup>

## Background

Poz-o-pac is the trade name for a patented construction material consisting of a blend of hydrated lime, fly ash, and aggregate that was developed in the 1950s<sup>5</sup> and has been used in the construction of roadway base, highway shoulders, pavements, parking lots, and reservoir liners.<sup>6,7</sup>

Poz-o-pac was extensively used throughout the United States,<sup>8</sup> including at Midwest Generation, LLC's (MWG) Joliet 29 Generation Station ("Joliet 29 Station") in Joliet, Illinois as a liner in surface impoundment 2 (Pond 2), which is the subject of this dispute. The nominally

---

<sup>1</sup> Illinois Environmental Protection Agency, Recommendation of the Illinois Environmental Protection Agency in the Matter of Petition of Midwest Generation for an Adjusted Standard from 845.740(a) and Finding of Inapplicability of Part 845 (Joliet 29 Station), February 4, 2022.

<sup>2</sup> Coal combustion residual (<https://www.epa.gov/coalash/coal-ash-basics>).

<sup>3</sup> Page 9 of Recommendation of the Illinois Environmental Protection Agency.

<sup>4</sup> The full sentence on page 13 of Recommendation of the Illinois Environmental Protection Agency reads as follows: "For the reasons provided above, Illinois EPA maintains that the poz-o-pac and black silty gravel material are CCR or CCR combined with other materials and are therefore a potential source of contamination in the groundwater."

<sup>5</sup> Benson C.H. and Bradshaw S., "User Guideline for Coal Fly Ash in Green Infrastructure Construction", Recycled Materials Resource Center, University of Wisconsin-Madison, Madison, WI, December 2011.

<sup>6</sup> G. & W. H. Corson, Inc. v. Commissioner, Docket Nos. 6365-65, 6334-66, United States Tax Court, Filed March 30, 1970.

<sup>7</sup> Chester W.H., Collins R.J. and MacKay M.H., "User Guidelines for Waste and By-Product Materials in Pavement Construction", FHWA-RD-97-148, Federal Highway Administration, McLean, VA, April 1998.

<sup>8</sup> *Op. cit.*

March 21, 2022

Page 2

12-inch thick Poz-o-pac liner at Pond 2 was installed circa 1978.<sup>9</sup> The Poz-o-pac was specified to consist of 3% hydrated lime, 20% fly ash, and 77% boiler slag aggregate, with a density of 136.9 pcf, and its surface to be sealed with a bituminous seal coat.<sup>10</sup> MWG relined Pond 2 in 2008 by installing the following components on top of the existing Poz-o-pac liner (from bottom to top): a geotextile cushion, a 60-mil high-density polyethylene (HDPE) geomembrane liner, a top geotextile cushion, a 12-inch thick sand cushion layer, and nominally 6-inch limestone warning layer.<sup>11</sup>

### Discussion of Illinois EPA Terminology

In Section III.d.i of the Recommendation of the Illinois Environmental Protection Agency titled “*MWG’s poz-o-pac is CCR material*,” the Illinois EPA provides the following definition of CCR: “fly ash, bottom ash, boiler slag, and flue gas desulfurization materials generated from burning coal for the purpose of generating electricity....”.<sup>12</sup>

Further, in Section III.d.iii of the Recommendation of the Illinois Environmental Protection Agency, the following is stated: “Illinois EPA maintains that the Poz-o-pac and black silty gravel material are CCR or CCR combined with other materials and are therefore a potential source of contamination in the groundwater.” It is unclear whether this statement is specific to the “black silty gravel” and “unconsolidated poz-o-pac” described elsewhere in Section III.d.iii or whether it pertains to any Poz-o-pac material including the Poz-o-pac liner.

Illinois EPA’s characterization of MWG’s Poz-o-pac as “CCR” and “CCR material” is ambiguous and technically incorrect. While Poz-o-pac is made using CCR, Poz-o-pac does not meet the above Illinois EPA’s definition of CCR due to changes in chemical composition and/or physical encapsulation of the raw CCRs (fly ash and boiler slag aggregate), as discussed below.

Depending on the type and composition, fly ash may possess cementitious (self-cementing) and/or pozzolanic properties.<sup>13</sup> Fly ash present in the Poz-o-pac reacts chemically with lime and water to form a hardened cementitious paste.<sup>14</sup> The primary product of this chemical reaction

---

<sup>9</sup> Drawing Sheet titled “*Ponds & Basins Profiles Sections & Details*” Approved for Construction on June 17, 1978, Commonwealth Edison Company Waste Water Treatment Facilities Joliet 7 – 8, prepared by NUS Corporation.

<sup>10</sup> *Op. cit.*

<sup>11</sup> Midwest Generation, LLC’s Petition for an Adjusted Standard and a Finding of Inapplicability for the Joliet 29 Station, In the Matter of: Petition of Midwest Generation for an Adjusted Standard from 845.740(A) and Finding of Inapplicability of Part 845. May 11, 2021, Exhibit 15.

<sup>12</sup> This is a defined term in the Illinois Environmental Protection Act (415 ILCS 5/3.142).

<sup>13</sup> Meyers J.F., Pichumani R., and Kapples B.S., “Fly Ash as a Construction Material for Highways, A Manual”, GAI Consultants, Inc., May 1976.

<sup>14</sup> This process is not unlike the reaction that occurs in Roman concrete, in which volcanic ash, a pozzolanic material like fly ash, reacts with lime and water to form a hardened cementitious paste.



March 21, 2022

Page 3

(referred to as the pozzolanic reaction) is a compound known as calcium silicate hydrate (CSH), which is also the primary reaction product of portland cement hydration (reaction of portland cement with water) in ordinary portland cement (OPC) concrete.<sup>15</sup> The secondary reaction product of portland cement hydration in OPC concrete is hydrated lime (calcium hydroxide). For several decades, fly ash has been commonly added to OPC concrete as a supplementary cementitious material (SCM), by typically replacing 15 to 30 percent of portland cement,<sup>16</sup> to improve both fresh and hardened concrete properties. When fly ash reacts with lime in concrete, it forms more CSH. Therefore, Poz-o-pac is compositionally similar to OPC concrete or concrete containing fly ash.

Further, akin to fly ash added to OPC concrete, fly ash in the Poz-o-pac becomes chemically bound and physically encapsulated in the hardened cementitious matrix.<sup>17</sup> Therefore, much like it would be inappropriate to characterize OPC concrete containing fly ash as “CCR” or “CCR material”, it is not appropriate to characterize Poz-o-pac as “CCR” or “CCR material”.

While the boiler slag aggregate reportedly used in Pond 2's Poz-o-pac liner is non-reactive (and thus is not chemically bound by the reaction of other Poz-o-pac constituents), it is physically encapsulated in the hardened cementitious matrix, similar to coarse and fine aggregate particles in OPC concrete. As shown in Figure 1, which depicts a Poz-o-pac core sample reportedly extracted from the ash pond liner at Will County Generation Station in Romeoville, Illinois,<sup>18,19</sup> Poz-o-pac is visually indistinguishable from OPC concrete.

In summary, it is Exponent's opinion that Poz-o-Pac does not meet the Illinois EPA's definition of CCR due to changes in chemical composition and/or physical encapsulation of the raw CCR ingredients (fly ash and boiler slag aggregate).

---

<sup>15</sup> Lea, F.M. and Hewlett, P.C., “Lea's Chemistry of Cement and Concrete”, Fourth Edition, New York: Elsevier Butterworth-Heinemann, 2004.

<sup>16</sup> Federal Highway Administration (FHWA), Fly Ash Facts for Highway Engineers, <https://www.fhwa.dot.gov/pavement/recycling/fach03.cfm> (last accessed 3/15/2022).

<sup>17</sup> Environmental Protection Agency (EPA), Report to Congress: Wastes from The Combustion of Fossil Fuels – Volume 2 (Report No. EPA 530-S-99-010) published in 1999, states in Section 3.0 Comanaged Wastes at Coal-Fired Utilities, as follows: “Construction fills include structural fills, flowable fills, and road base and subbase applications. Most of the bottom ash and a considerable portion of the fly ash utilized are applied in construction fills. This application of UCCWs [utility coal combustion wastes] ranks second following the use of UCCWs in concrete and cement products... Because of their alkalinity and presence of solids, UCCWs are used to chemically fix potentially hazardous wastes in a solid matrix. Through stabilization, hazardous organic and inorganic constituents are immobilized and prevented from being released to the environment.” Exponent interprets this EPA statement as being directly applicable to the presence of fly ash in Poz-o-pac.

<sup>18</sup> Drawing Sheet titled “Ash Ponds” dated November 1977, Commonwealth Edison Company, Will County Station, Wastewater Treatment, prepared by Harza Engineering Company.

<sup>19</sup> Deposition of Mr. Richard Gnat in the Matter of Sierra Club, Environmental Law and Policy Center, Prairie Rivers Network, and Citizen Against Ruining the Environment vs Midwest Generation, LLC, October 26, 2017.

March 21, 2022

Page 4

### **Limitations**

This evaluation addressed specific concerns at the subject property and may not be adequate for other purposes. Use of the findings, conclusions, or recommendations presented herein for any other purpose is at the sole risk of the user. Exponent has exercised usual and customary care in the conduct of this assessment. No guarantee or warranty as to future performance of any reviewed condition is expressed or implied.

The findings herein are made to a reasonable degree of engineering certainty based on information available to Exponent as of the date of this report. Exponent may supplement this report to expand or modify our findings based on review of additional information as it becomes available.

Sincerely,

A handwritten signature in black ink, appearing to read "Mateusz Radlinski".

Mateusz Radlinski, Ph.D.  
Senior Managing Engineer

Enclosures (1)

March 21, 2022  
Page 5



Figure 1. 3-inch diameter Poz-o-pac core sample reportedly extracted from the ash pond liner at Will County Generation Station. Photograph on the left and sample on the right provided by Ms. Kristen Laughridge Gale.



**Exponent**<sup>®</sup>  
Engineering & Scientific Consulting

## Mateusz Radlinski, Ph.D., P.E.

Senior Managing Engineer | Buildings & Structures  
149 Commonwealth Drive | Menlo Park, CA 94025  
(650) 688-6752 tel | [mradlinski@exponent.com](mailto:mradlinski@exponent.com)

### Professional Profile

Dr. Radlinski specializes in concrete and cement-based materials. He has extensive experience investigating problems associated with all aspects of concrete construction including installation deficiencies, concrete material failures and performance concerns in a wide range of applications, including structural building components, foundations, parking structures, bridges, floor slabs, pavements, prestressed and post-tensioned concrete, water containment and environmental structures, concrete pipe and industrial chimneys. Dr. Radlinski's areas of expertise include analysis and optimization of concrete mix design, characterization of chemical composition and physical properties of concrete, and evaluation of durability-related concrete failures including cracking, chemical attack, corrosion, and freeze-thaw damage. He has also evaluated failures of various cement-based materials such as stucco, flooring underlayments, fiber-cement siding, asbestos-cement pipe, tile thinset, swimming pool plaster, and oilwell cement. Dr. Radlinski has conducted numerous flooring failure investigations related to moisture problems, installation, and material performance and compatibility. He has also specific expertise in condition assessment and service life analysis of asbestos-cement pipe.

Prior to joining Exponent, Dr. Radlinski was a research assistant at Purdue University, where he contributed to several research projects funded by the Indiana Department of Transportation. That research focused on optimization of ternary cementitious systems (containing fly ash and silica fume) for bridge deck concrete, investigation into the causes for premature deterioration of joints in rigid pavement, instrumentation and monitoring of structural behavior of prestressed high-strength concrete girders and high-performance concrete bridge deck, and field installation and performance assessment of commercial rapid-setting repair materials.

Dr. Radlinski's academic background also includes design of steel, reinforced concrete and wood structures, including a Master's thesis on reliability-based optimization of space trusses.

### Academic Credentials & Professional Honors

Ph.D., Civil Engineering, Purdue University, 2008

M.S., Civil Engineering, Szczecin University of Technology, Poland, 2004

Hugh W. and Edna M. Donnan Scholarship, 2008

Purdue University Graduate Student Award for Outstanding Teaching, 2008

Magoon Outstanding Teaching Assistant Award, 2008

William L. Dolch Graduate Scholarship for Outstanding Research in Materials Science, 2006

Polish Ministry of Infrastructure Distinguished Thesis Award for Master's Thesis, 2005

### Licenses and Certifications

Licensed Professional Civil Engineer, California, # 77089

### Professional Affiliations

American Society of Civil Engineers

American Concrete Institute

Transportation Research Board Committee on Properties of Concrete (AFN20)

### Languages

Polish

### Publications

Radlinski M, Wolf J. Condition assessment and service life analysis of an asbestos-cement sewer pipe. Proceedings, Pipelines 2016, pp. 321-333, Kansas City, MO, July 17-20, 2016.

Radlinski M, Olek J. Effects of curing conditions on the properties of ternary (ordinary portland cement/fly ash/silica fume) concrete. ACI Materials Journal 2015; 112(1):49-58.

Harris N, Radlinski M. Asbestos-cement pipe condition assessment and development of optimum replacement methodology. Proceedings, 6th Congress on Forensic Engineering, pp. 268-279, San Francisco, CA, October 31-November 3, 2012.

Radlinski M, Olek J. Investigation into the synergistic effects in ternary cementitious systems containing portland cement, fly ash and silica fume. Cement and Concrete Composites 2012; 34(4):451-459.

Del Mar Arribas-Colón M., Radlinski M., Olek J., and Whiting N.M. Investigation of premature distress around joints in PCC pavements: Parts I & II. FHWA/IN/JTRP-2012/25 & FHWA/IN/JTRP-2012/26. Joint Transportation Research Program, Indiana Department of Transportation and Purdue University, West Lafayette, Indiana, 2012.

Radlinski M, Moncarz P, Harris N. Concrete spalling in slip-form constructed industrial chimney. Proceedings, 25th Engineering Conference on Structural Failures, Szczecin-Miedzyzdroje, Poland, May 24-27, 2011, pp. 1037-1044.

Radlinski M, Harris N, Moncarz P. Sustainable concrete: Impacts of existing and emerging materials and technologies on the construction industry. Proceedings, 2011 Architectural Engineering National Conference, pp. 252-262, Oakland, CA, March 30-April 2, 2011.

Radlinski M, Olek J, Nantung T. Shrinkage and cracking of ternary concrete under various curing conditions. Concrete International 2011; 33(1):49-55.

Radlinski M, Olek J. High-performance concrete bridge decks: a fast-track implementation study. Volume 2: Materials, FHWA/IN/JTRP-2008/29-2, Publication FHWA/IN/JTRP-2008/29-2, Joint Transportation Research Program, Indiana Department of Transportation and Purdue University, West Lafayette, IN, 2010.

Mateusz Radlinski, Ph.D., P.E.

04/20 | Page 2

Radlinski M, Olek J, Nantung T. Development and application of maturity method for prediction of concrete's resistance to chloride ion penetration. Transportation Research Record, Vol. 2164, Transportation Research Board of the National Academies, pp. 105-112, Washington D.C., 2010.

Radlinski M, Olek J, Zhang Q, Peterson K. Evaluation of the critical air-void system parameters for freeze-thaw resistant ternary concrete using the manual point-count and the flatbed scanner methods. Journal of ASTM International 2010; 7(4).

Peterson K, Sutter L, Radlinski M. The practical application of a flatbed scanner for air-void characterization of hardened concrete. Journal of ASTM International 2009; 6(9).

Radlinski M, Olek J. Assessing the critical air-void system parameters for freeze-thaw resistant ternary concrete using the manual point-count and a flatbed scanner. 88th Annual Transportation Research Board Meeting (CD-ROM), TRB, Washington, D.C., 2009.

Radlinski M, Olek J, Nantung T. Influence of curing conditions on strength development and strength predictive capability of maturity method. Laboratory and field-made ternary concretes. Transportation Research Record, Vol. 2080, Transportation Research Board of the National Academies, pp. 49-58, Washington D.C., 2008.

Radlinski M. Evaluation of applicability of ternary OPC/FA/SF binder systems for bridge deck concrete. Ph.D. Dissertation, Purdue University, West Lafayette, IN, December 2008.

Radlinski M, Olek J, Nantung T. Effect of mixture composition and initial curing condition on scaling resistance of ternary (OPC/FA/SF) concrete. Journal of Materials in Civil Engineering 2008; 20(10):668-677.

Radlinski M, Olek J, del Mar Arribas M, Rudy A, Nantung T, Byers M. Influence of air-void system parameters on freeze-thaw resistance of pavement concrete — Lessons learned from field and laboratory observations. Proceedings, 9th International Conference on Concrete Pavements, pp. 824-83, San Francisco, CA, August 17-21, 2008.

Radlinski M, Olek J, Nantung T. Evaluation of transport-related properties of ternary (OPC/FA/SF) concrete mixtures using migration- and absorption-type tests. Proceedings, 9th CANMET/ACI Conference on Fly Ash, Silica Fume, Slag, and Natural Pozzolans in Concrete, SP-242, ACI, pp. 281-497, 2007.

Radlinski M, Olek J, Zander A, Nantung T. Influence of production method and curing conditions on chloride transport, strength and drying shrinkage of ternary mix concrete, transport properties and concrete quality. Materials Science of Concrete Special Volume, American Ceramics Society, Wiley & Sons, pp. 215-229, 2007.

Olek J, Radlinski M, del Mar Arribas M. Premature deterioration of joints in selected Indiana portland cement concrete pavements. Proceedings, 23rd Conference on Structural Failures, Szczecin-Miedzydroje, Poland, pp. 859-868, 2007.

Radlinski M, Olek J, Kim H, Nantung T, Zander A. Preliminary optimization analysis of ternary mixtures for bridge decks. Proceedings, International Symposium Brittle Matrix Composites, pp. 161-174, Warsaw, Poland, October 23-25, 2006.

Paczkowski WM, Radlinska A, Radlinski M, Radlinski L. Quasi-evolutional polyoptimization of a barrel vault spatial truss. Proceedings, XXII National Conference on Polyoptimization and Computer Aided Design, pp. 144-151, Mielno, Poland, June 2004.

Badower A, Radlinska A, Radlinski M, Radlinski L. Stochastic character of cross sections of bars

catalogue. Proceedings, National Conference on Polyoptimization and Computer Aided Design, pp. 11-12, Mielno, Poland, June 2004.

Paczkowski WM, Radlinska A, Radlinski M, Radlinski L. Polyoptimization analysis of a barrel vault spatial truss. Proceedings, 3rd International Conference of Students Scientific Groups, pp. 33-39, Siedlce, Poland, September 2004.

Radlinski M, Radlinska A. Optimization of the spatial truss with random decision variables. M.S. Thesis, Szczecin University of Technology, Poland, 2004. (In Polish).

### **Presentations**

Radlinski M., McDonald B. Jayapalan A. A case study of very early-age concrete cracking in airfield pavement. American Concrete Institute (ACI) Fall Convention 2017, Anaheim, CA, October 15, 2017.

Radlinski M, Olek J, Nantung T. The influence of curing on the early age properties of ternary concrete. American Concrete Institute (ACI) Fall Convention 2017, Anaheim, CA, October 15, 2017.

Radlinski M. Assessment of aging asbestos cement pipe systems. Live Audio Conference, Lorman Education Services, April 20, 2017.

Radlinski M, Wolf J. Condition assessment and service life analysis of an asbestos-cement sewer pipe. Pipelines 2016, Kansas City, MO, July 17-20, 2016.

Harris N, Radlinski M, Wolf J. Laboratory evaluation of asbestos cement distribution mains: Current state of the art of testing AC pipe. American Water Works Association Annual Conference & Exposition (ACE), Denver, CO, June 9-12, 2013.

Radlinski M, Harris N. Asbestos cement pipe condition assessment and optimum replacement methodology. Live Audio Conference, Lorman Education Services, May 17, 2012.

Harris N, Radlinski M, Lyons T. Asbestos-cement pipe condition assessment and development of methodology for optimum replacement in water distribution systems. 2010 American Water Works Association Distribution Systems Symposium and Exposition, National Harbor, MD, September 19-22, 2010.

Radlinski M, Olek J, del Mar Arribas M, Rudy A, Nantung T, Byers M. Investigation into causes of premature deterioration of joints in PCC pavements in Indiana. 2008 PCCP Workshop & Expo, Indianapolis, IN, February 5-6, 2008.

Radlinski M, Olek J, Frosch R, Zander A, Nantung T. INDOT experience with use of HPC for bridge decks. Crack Free Bridge Deck Workshop, Indianapolis, IN, October 4, 2007.

### **Poster Presentations**

Radlinski M, Olek J, Nantung T. Effect of curing method on properties of ternary (OPC/FA/SF) concrete. 9th International Conference on Concrete Pavements, San Francisco, CA, August 17-21, 2008.

Radlinski M, Olek J, del Mar Arribas M, Rudy A, Nantung T, Byers M. Influence of air-void system parameters on freeze-thaw resistance of pavement concrete — Lessons learned from field and laboratory observations. 87th TRB Annual Meeting, Washington, D.C., January 13-17, 2008.

Radlinski M, Olek J, Nantung T. Effect of mixture composition and initial curing condition on early and late age scaling resistance of ternary (OPC/FA/SF) mixtures. 86th TRB Annual Meeting, Washington, D.C., January 21-25, 2007.



Radlinski M, Olek J, Nantung T. Using maturity method to estimate the resistance of HPC to chloride-ion penetration. Semiannual ACBM Meeting, Evanston, IL, November 2007.

Radlinski M, Kim H, Olek J and Nantung T. Preliminary optimization analysis of ternary HPC mixtures for bridge decks. Semiannual ACBM Meeting, Chicago, IL, September 2006.

### Peer Reviewer

ASCE Journal of Materials in Civil Engineering

Cement and Concrete Composites

RILEM Materials and Structures

Transportation Research Record

Journal of Environmental Management

# **EXHIBIT 26**

**BEFORE THE ILLINOIS POLLUTION CONTROL BOARD**

<b>IN THE MATTER OF:</b>	)	
	)	
<b>Petition of Midwest Generation</b>	)	
<b>for an Adjusted Standard from 845.740(a)</b>	)	
<b>and Finding of Inapplicability of Part 845</b>	)	<b>AS 2021-001</b>
<b>(Joliet 29)</b>	)	
	)	
	)	
<b>Respondents.</b>	)	

**AFFIDAVIT OF PATRICK ALLENSTEIN**

I, Patrick Allenstein, being first duly sworn on oath, depose and state as follows:

1. I am over the age of 18 years and am a resident of Wisconsin.
  
2. The information in this Affidavit is based on my personal knowledge or belief in my capacity as a Senior Geologist with the environmental consulting firm KPRG and Associates, Inc. (KPRG). KPRG has served as an environmental consultant to Midwest Generation, LLC (MWG) since 2005 regarding the management of various coal combustion residual (CCR) and coal combustion by-product (CCB) issues, including at Joliet 29 Station, and I would testify to such matters if called as a witness.
  
3. In 2005, KPRG collected stratigraphical and geotechnical data from the vicinity of various ponds at six different MWG stations. Collection of the stratigraphical and geotechnical data can be accomplished using geoprobe rig.
  
4. On August 10, 2005, I collected and visually analyzed in the field the soil from six borings at Joliet 29 Station, (JS29-GT-1 through JS29-GT-6). Two of the borings, JS29-GT-2 and JS29-GT-3 were taken from the embankments of Pond 2.

5. I visually analyzed the soil cores taken at each of the six MWG Stations and recorded my observations pursuant to the Unified Soil Classification System ("USCS"), as described in ASTM D 2487 and ASTM D 2488.

6. I am familiar with the characteristics of bottom ash, fly ash, and slag (collectively "CCR"). Where CCR is present in the boring log, I specifically note its presence in the description column of the boring log.

7. In the boring log for JS29-GT-2, I did not identify CCR in the boring log beyond a depth of 1-foot. Because I am able to identify CCR, had CCR been present in the boring log I would have identified it.

8. In the boring log JS29-GT-3, I identified CCR in the top foot of the boring log, but not deeper into the boring log. Had I seen CCR deeper in the boring log, I would have logged the CCR in the boring log.

Under penalties as provided by law pursuant to Section 1-109 of the Code of Civil Procedure, the undersigned certifies that the statements set forth in this instrument are true and correct, except as to matters therein stated to be on information and belief and as to such matters the undersigned certifies as aforesaid that he verily believes the same to be true.

FURTHER AFFIANT SAYETH NOT.



---

Subscribed and Sworn to before me  
On MARCH 9, 2022.

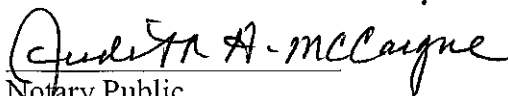
  
Notary Public

My Commission Expires: 4-7-2025

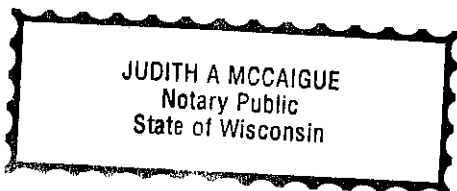

# **EXHIBIT 27**



DRAFT – ATTORNEY WORK PRODUCT 3/18/22

**BEFORE THE ILLINOIS POLLUTION CONTROL BOARD**

**IN THE MATTER OF:** )

**Petition of Midwest Generation** )

**for an Adjusted Standard from 845.740(a)** )

**and Finding of Inapplicability of Part 845 )**

**(Joliet 29)** )

**AS 2021-001**

**Respondents.** )

**AFFIDAVIT OF STEVEN KROLL**

I, Steven Kroll, being first duly sworn on oath, depose and state as follows:

1. I am over the age of 18 years and am a resident of Illinois.
2. The information in this Affidavit is based on my personal knowledge or belief in my capacity as a Geologist at the environmental engineering firm Patrick Engineering, Inc. (Patrick Engineering). I would testify to such matters if called as a witness.
3. In 2010, Patrick Engineering was retained by Midwest Generation, LLC (MWG) to conduct an hydrogeologic assessment at the Joliet 29 Station and install eleven groundwater monitoring wells around the perimeter of the ash ponds.
4. From late October to early November 2011, Patrick Engineering installed monitoring wells across multiple MWG stations, and during installation collected soil borings using hollow-stem augers.
5. On November 1 and 2, 2010, four soil cores were collected and visually analyzed by Patrick Engineering in the vicinity of Pond 2 at Joliet 29 Station where MW-03, MW-04, MW-05 and MW-10 were installed (Borings B-MW-3 through 5, 10).
6. The employee who visually inspected and logged the soil in the boring logs, Andrew Gagnon, is no longer employed by Patrick Engineering.



DRAFT – ATTORNEY WORK PRODUCT 3/18/22

7. As part of my duties as an employee of Patrick Engineering, I have taken, analyzed, and logged my observations of soil cores into boring logs.

8. I am familiar with the Unified Soil Classification System (USCS), otherwise known as ASTM D 2487 and ASTM D 2488. It is the general practice and procedure of Patrick Engineering to analyze soil cores and record the observations in the boring log according to the USCS.

9. Where the presence of bottom ash, fly ash, and slag (collectively “CCR”) is confirmed in a soil core, it is also the practice and procedure of Patrick Engineering to identify it in the boring log description.

10. I have reviewed the Joliet 29 boring logs for B-MW-3, B-MW-4, B-MW-5, and B-MW-10. Each boring log appears to have been prepared in accordance with the generally accepted practices of Patrick Engineering.

11. Joliet 29 boring logs B-MW-3, B-MW-4, B-MW-5, and B-MW-10 do not identify CCR material within the soil core.

Under penalties as provided by law pursuant to Section 1-109 of the Code of Civil Procedure, the undersigned certifies that the statements set forth in this instrument are true and correct, except as to matters therein stated to be on information and belief and as to such matters the undersigned certifies as aforesaid that he verily believes the same to be true.

FURTHER AFFIANT SAYETH NOT.

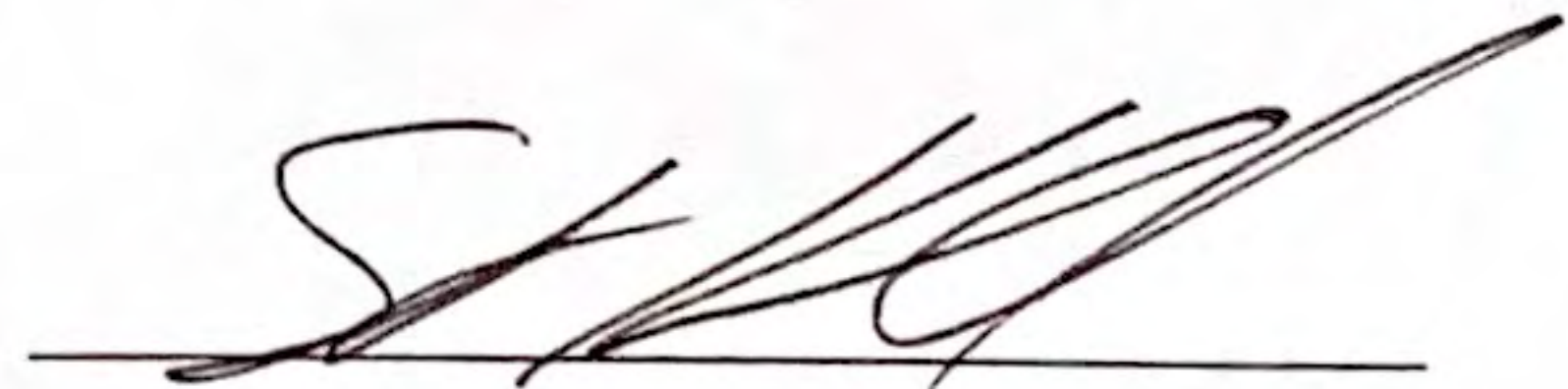

Subscribed and Sworn to before me  
On March 18, 2022.

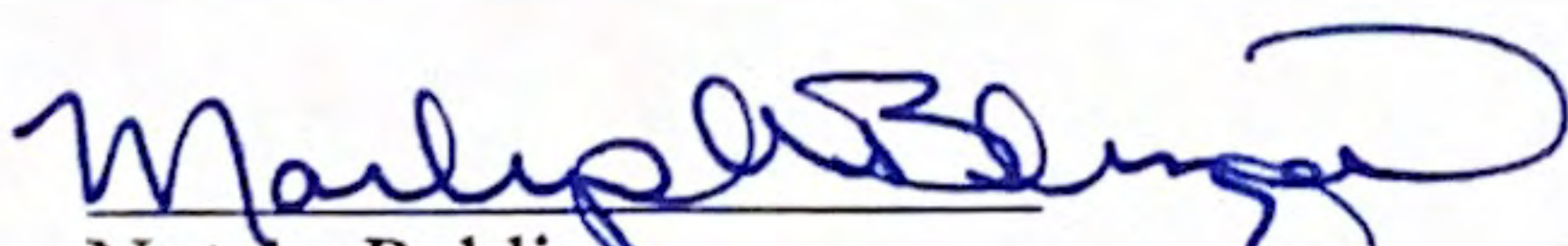
  
Notary Public



My Commission Expires: 8-27-2025



# **EXHIBIT 28**



**Thomas J. Dehlin, P.E.**

Project Engineer (Licensed in IL, KY, and WY)  
(312) 269-6373  
tdehlin@sargentlundy.com

March 24, 2022

**Re: Illinois Environmental Protection Agency's Recommendation in the Matter of Midwest Generation, LLC's Petition for an Adjusted Standard from 845.740(a) for Pond 2 at the Joliet 29 Station (AS 2021-001)**

Dear Members of the Board:

I have prepared this letter in response to the Illinois Environmental Protection Agency's ("Agency") recommendation that the Board deny Midwest Generation, LLC's ("MWG") Petition for an Adjusted Standard from 845.740(a) ("Petition") that would allow MWG to decontaminate and retain the existing high-density polyethylene (HDPE) geomembrane liner in Pond 2 at MWG's Joliet 29 Generating Station ("Joliet 29" or the "Station") when the pond is converted into a low-volume waste pond. Because Pond 2 is a coal combustion residual (CCR) surface impoundment, § 845.740(a) of Title 35 to the Illinois Administrative Code (35 Ill. Adm. Code) would otherwise require MWG to remove Pond 2's existing liner as part of converting the pond into a low-volume waste pond. As detailed in the Agency's filing with the Office of the Clerk of the Illinois Pollution Control Board on February 4, 2022 ("Recommendation"), the Agency recommends the Board deny MWG's Petition. This letter addresses the following items in the Agency's Recommendation:

1. The Agency's claim that MWG "knowingly used CCR material, including coal ash (or "black silty gravel") as structural fill or foundational backfill in the 2008 construction of Pond 2's current HDPE liner system without meeting the [Illinois Environmental Protection Act]'s coal combustion byproduct ("CCB") requirements for beneficial reuse." See Recommendation at 9.
2. The Agency's implication that Pond 2's existing HDPE geomembrane liner has suffered degradation due to its exposure to the elements. See Recommendation at 20.

## Fill Material for the HDPE Geomembrane Liner Subgrade

In her affidavit filed as Exhibit A to the Agency's Recommendation, Ms. Lauren Martin of the Agency references a picture that I included in a January 18, 2022 letter<sup>1</sup> to the Agency which shows the first panels of the HDPE geomembrane liner and underlying non-woven geotextile being installed along the interior side slope of Pond 2's eastern embankment. Based on this photograph, Ms. Martin claims, "The side slope of the impoundment subgrade is compacted black to dark brown silty gravel and the bottom is poz-o-pac smoothed over with fine to coarse-grained material—potentially the aforementioned black silty gravel and unconsolidated poz-o-pac." Later in her affidavit, citing the liner subgrade preparation plan drawing for Pond 2's HDPE geomembrane liner included in the pond's History of Construction, Ms. Martin claims, "MWG removed between one to three feet of the black silty gravel material and/or poz-o-pac along the internal side slopes of the embankment and then reused the black silty gravel material to rebuild the side slopes of the embankments." Based on her assumption that the black silty gravel is "CCR or CCR combined with other materials," Ms. Martin concludes, "MWG had knowledge of the nature of the CCR material being reused prior to construction and knowingly reutilized the CCR materials for geotechnical applications, seemingly without testing for environmental suitability." See Rec., ex. A at 5 to 6.

Based on my review of the photograph of the liner subgrade included in my January 18, 2022 letter and of two additional photographs taken of the liner subgrade during the 2008 Pond 2 re-lining project, I disagree that the material underlying Pond 2's existing HDPE geomembrane liner and geotextile cushion is black silty gravel or CCR. These three photographs are enclosed in Att. 1, which I have annotated with my observations to support my opinions and conclusions presented herein.

In her affidavit, Ms. Martin does not indicate which material she believes to be black silty gravel. Based on the lighting in Photograph 1-1, which was the photograph submitted with my January 18, 2022 letter to the Agency, I am presuming Ms. Martin believes the darker material near and upslope from the base of the marker post in the foreground of the photograph to be black silty gravel. Photograph 1-2 provides a close-up of this area with better lighting and shows the material is actually dark brown sand and gravel, not black silty gravel or CCR. This material observed along the interior slope of Pond 2's eastern embankment is consistent with the soils observed at similar elevations in the three borings of which I am aware that have been drilled through Pond 2's eastern embankment: B-MW-3 and B-MW-4 drilled by Patrick Engineering in 2011 and boring J-B-1 drilled by Geosyntec in 2016. See Att. 2 at 25 to 28 and Att. 3 at 3 to 4, respectively.

Regarding Ms. Martin's claim that MWG removed one to three feet of CCR material from the interior side slopes of Pond 2 and reused the material to rebuild the pond's embankments, a comparison of the topographic surveys for the area that were prepared by Ruettiger, Tonelli & Associates, Inc. before and after the pond's HDPE geomembrane liner was installed in 2008

---

<sup>1</sup> The affidavit references Sargent & Lundy's December 9, 2021 letter to the Agency, but the referenced photograph was included in Sargent & Lundy's January 18, 2022 letter to the Agency.

indicates that portions of the pond's interior side slopes were regraded prior to installing the new HDPE geomembrane liner. The topography of the site before the pond was re-lined is shown on Sheet C020 from Pond 2's 2016 History of Construction; the contours are labeled as "ground surface contours" and are shown in gray. See Att. 4. Meanwhile, the as-built topographic survey is provided in Att. 5.

Based on my review of both topographic surveys, the most significant regrading work occurred in the northeastern/eastern corner of the pond, which I have annotated on the map in Att. 5. It also appears similar regrading work occurred along the upper five feet of the western embankment's interior side slope, while little to no regrading work was done along the interior side slopes of the Pond 2's northern and southern embankments. As shown on Sheet C020, the upper 10 feet of the pond's northeastern/eastern corner originally exhibited an approximately 1-horizontal-to-1-vertical (1H:1V) slope, significantly steeper than the approximately 3H:1V slopes typical of the remainder of the eastern embankment's interior side slope. Meanwhile, a portion of Pond 2's western embankment had 2H:1V interior side slopes. Per Section 02300, Article 3.05 of the Technical Specifications<sup>2</sup> issued for the 2008 re-lining of Ponds 1 and 2, the contractor was instructed to regrade Pond 2's interior side slopes to 3H:1V slopes. See Att. 6. This regrading work would provide a more uniform and stable slope for the pond's new liner in the aforementioned areas where steeper slopes were present. To meet this requirement, the contractor likely cut the upper few feet of material in the northeastern/eastern corner and western edge of the pond. Indeed, the tops-of-slope / edges of road in these areas are further out from the pond's storage area on the 2008 as-built topographic survey than on the topographic survey showing the pond's shape and grade before the re-lining work; this suggests that material was cut from the interior slopes in these areas to achieve shallower slopes.

The original 1H:1V slope of Pond 2's northeastern/eastern corner is important to note because it is unlikely that a granular material like bottom ash would be stable at this slope given the natural angle of repose for dry, sand-like materials generally does not exceed 39°<sup>3</sup>, or approximately 1.2H:1V. Steeper slopes are generally comprised of cohesive materials like clays. Indeed, boring J-B-1 drilled in 2016 by Geosyntec near the area that was cut in 2008 shows that the upper 10 feet of the embankment is primarily composed of a light brown clay. Therefore, the material removed from this area in 2008 to achieve a shallower slope for Pond 2's HDPE geomembrane liner was likely clay fill that was used to construct the pond's eastern embankment, not CCR.

As previously stated, "cuts" made along Pond 2's interior side slopes were likely specified to achieve shallower, more uniform slopes and rounded corners to facilitate installation of the new

---

<sup>2</sup> Although the technical specifications provided in Attachment 6 are not the final technical specifications for construction, it may be inferred from the construction records that the specifications for the Pond 2 re-lining work were finalized as proposed in the attached August 3, 2007 version or were finalized with minimal changes that did not have significant impacts on how the contractor was instructed to execute the re-lining work.

<sup>3</sup> See Figure 7 of U.S. Navy, *Soil Mechanics*, NAVFAC Design Manual 7.1, Naval Facilities Engineering Command, Arlington, VA, September 1986.

geomembrane liner. Interestingly, the only notable “fill” area (*i.e.*, an area where material was placed on the interior slope of an embankment) that I identified when comparing the topographic map shown on Sheet C020 in Att. 4 and the as-built topographic map in Att. 5 was near the center of Pond 2’s eastern embankment. See Att. 5. Therefore, it appears that significantly more material was “cut” from the interior slopes of the pond’s embankments than “fill” was placed to achieve approximately uniform 3H:1V slopes along the interior of the pond for the liner subgrade. In this case, the contractor would have had excess material from the liner subgrade preparation work. Because it would have been more economical to re-use this material for the project than to dispose of it at an off-site landfill, the contractor would have likely (1) stockpiled the material for future use and/or (2) spread this material along the pond floor above the existing Poz-O-Pac liner.

As Ms. Martin notes in her affidavit, Photograph 1-1 in Att. 1 shows fill material above the Poz-O-Pac liner along Pond 2’s floor adjacent to the interior slope of the pond’s eastern embankment. Photograph 1-3 in Att. 1 shows a broader view of Pond 2’s floor and the interior slopes at the northeastern end of the pond. This photograph was taken two days before Photographs 1-1 and 1-2 by the construction quality assurance (CQA) inspector charged with inspecting the pond’s subgrade prior to the subgrade being approved to receive Pond 2’s new HDPE geomembrane liner. Accordingly, this photograph was taken after the northeastern/eastern corner of the pond, which is shown on the right-hand side of the photograph, was regraded from a 1H:1V slope to a shallower 3H:1V slope. Notably, the surficial materials on this finished slope, as well as the other subgrades that appear not to have been cut, shown in the photograph are dark brown to brown, not black, further supporting the conclusion that the material is not CCR.

Photograph 1-3 also shows fill material over the top of the Poz-O-Pac liner along the pond floor<sup>4</sup>. Based on the knowledge that excess material was available from cutting portions of the pond’s embankments to achieve shallower interior side slope, this material is more likely from the contractor spreading excess material along the existing Poz-O-Pac to achieve a relatively flat surface as required by Section 02300, Article 3.05 of the Technical Specifications. See Att. 6. Although Ms. Martin attributes the granular fill material on the pond floor to be “unconsolidated” portions of the pond’s original Poz-O-Pac liner, it is my opinion that the material shown in these photographs is more likely excess gravel, sand, and clay material leftover from regrading the pond’s interior side slopes. More notably, this material does not appear to be CCR given its brown and dark brown color.

As discussed above, I disagree with Ms. Martin’s statement that MWG used CCR as fill material when preparing the subgrade for Pond 2’s new HDPE geomembrane liner in 2008. Based on the attached photographs, the liner subgrade is comprised of dark brown to brown fill materials, not black ash. Based on the attached soil boring logs and construction records, the materials along the embankment side slopes are dark brown to brown gravels, sands, and clays, not

---

<sup>4</sup> Photograph 1-3 also shows water present on the floor from recent precipitation but, as shown on Photographs 1-1 and 1-2, the subgrade was adequately dried by the time the contractor started deploying the new HDPE geomembrane liner and geotextile cushion.

black ash. Moreover, the material along the pond floor above its existing Poz-O-Pac liner is more likely than not excess embankment fill material leftover from cutting Pond 2's embankments back to shallower slopes that was then spread uniformly along the pond floor, not deterioration of the pond's original Poz-O-Pac liner.

### Condition of Pond 2's HDPE Geomembrane Liner

In her affidavit, Ms. Martin also questions the competency of Pond 2's existing HDPE geomembrane liner by insinuating the liner has likely sustained perforations due to overburden stresses and deterioration from being exposed to the sunlight and weather conditions, citing a 2011 technical paper on the effects of static and cyclic shear on geomembrane liners supported on granular soils<sup>5</sup> and a 2008 magazine article on the effects of ultraviolet (UV) exposure on geomembranes<sup>6</sup>, respectively. Specifically, Ms. Martin speculates, "While a geotextile cushion was installed beneath the HDPE liner in Pond 2, there are other factors that may cause damage to the liner. In addition to overburden stress, liners installed in impoundments that are exposed to sunlight and weather conditions suffer degradation that buried HDPE liners do not. The exposure to the elements can also deteriorate and/or cause wear and tear on the liner that would not otherwise occur." See Rec. Ex. A at 7. Referencing the preceding speculation by Ms. Martin and records of recent inspections<sup>7</sup> performed by MWG for Pond 2, the Agency insinuates that Pond 2's existing HDPE geomembrane liner has been damaged and thus would not be considered competent. See Rec. at 20.

### **Punctures from Overburden Stresses**

While Ms. Martin notes in her affidavit that a geotextile cushion was installed underneath Pond 2's HDPE geomembrane liner, it is important to note that a geotextile cushion was also installed above the liner to protect it from the sand cushion and gravel warning layers placed along the pond floor. Specifically, a 16-oz/sy non-woven geotextile was installed below the liner, and a 12-oz/sy non-woven geotextile was installed above the liner. See Att. 4, sheet C031, detail A. These geotextiles protect Pond 2's HDPE geomembrane liner from punctures and damage like that documented in the 2011 technical paper referenced by Ms. Martin in her affidavit, which evaluated the effects of static and cyclic shear on HDPE geomembrane liners supported on granular soils without geotextiles (*i.e.*, not the condition for Pond 2's liner).

Despite the presence of two non-woven geotextiles protecting Pond 2's HDPE geomembrane liner from the overlying sand cushion and gravel warning layers and from the underlying subgrade, the Agency recommends that, assuming the Board grants MWG's requested adjusted standard, the Board require MWG to conduct integrity testing of the HDPE geomembrane "where it may be perforated or damaged to determine the competency of the

---

<sup>5</sup> Patrick J. Fox et al., Technical Paper, *Geomembrane Damage Due to Static and Cyclic Shearing Over Compacted Gravelly Sand*, 18 Geosynthetics International. 272 (2011). See Rec., ex. I.

<sup>6</sup> Ian D. Peggs, *How Long Will My Liner Last? What is the Remaining Service Life of my HDPE Geomembrane?*, Geosynthetics Magazine, October 1, 2008. See Rec., ex. J.

<sup>7</sup> The inspection reports referenced by the Agency are dated October 13, 2021.



liner.” See Recommendation at 32. This recommendation seemingly ignores the beneficial service the two non-woven geotextiles have provided in protecting Pond 2’s liner from the overlying and underlying materials. Testing has shown that a 12-oz/sy non-woven geotextile (like the geotextile cushion installed above Pond 2’s liner) installed on both sides of a 60-mil (1.5-mm) HDPE geomembrane can provide more than double the level of protection to the geomembrane against puncture compared to the geomembrane’s puncture resistance alone. See Att. 12. Given the heavier 16-oz/sy non-woven geotextile underneath Pond 2’s geomembrane liner, an even greater resistance to puncture is expected here.

Given the non-woven geotextiles installed above and below Pond 2’s geomembrane liner, it is unlikely that Pond 2’s liner has sustained punctures from the overlying sand cushion and gravel warning layers or the underlying subgrade when the pond was in service. Therefore, I do not think the integrity testing recommended by the Agency for identifying punctures in the liner is warranted, especially because this could require cutting and removing relatively large samples of the liner (*i.e.*, intentionally destroying the intact liner) to visually inspect the underside of the liner.

### **UV Degradation**

While exposed HDPE geomembrane liners have a “shorter” lifespan than buried HDPE geomembrane liners, “shorter” is a relative term. Ongoing testing being conducted by the Geosynthetic Research Institute (GRI) (the early stages of which is referenced in the 2008 magazine article cited by Ms. Martin) estimate a lifespan greater than 36 years for a black, 60-mil HDPE geomembrane conforming to GRI’s GM13 Standard Specification<sup>8</sup> exposed to a dry and arid climate. See Att. 7, table 6 at 22. GRI’s GM 13 Standard Specification is provided in Att. 8 for reference.

In fact, the color of the geomembrane influences the lifespan, and a white geomembrane exhibits a lower UV degradation rate than a black geomembrane. As demonstrated by a 1993 study<sup>9</sup> on the benefits of white-surfaced HDPE geomembranes, the study’s authors found that the temperatures of a textured black geomembrane and a smooth white geomembrane to be 3°C lower and 24°C lower, respectively, than the temperature of a smooth black geomembrane under the same ambient conditions. See Att. 10 at 1066. As noted by the authors, “Increasing temperature accelerates both stress crack phenomena and oxidative degradation.” See Att. 10 at 1067. Accordingly, the authors concluded, “Lower temperatures provide several physical benefits such as...greater resistance to long-term degradation.” See Att. 10 at 1078.

Here, Pond 2’s liner was installed approximately 14 years ago. Per the Technical Specifications issued for re-relining Pond 2 in 2008, the HDPE geomembrane liner for Pond 2 was required to be white and textured and to conform to GRI GM 13. See Att. 6. Moreover, Pond 2 contained

---

<sup>8</sup> Geosynthetic Institute, *GRI – GM13 Standard Specification*, “Test Methods, Test Properties and Testing Frequency for High Density Polyethylene (HDPE) Smooth and Textured Geomembranes.”

<sup>9</sup> One of the paper’s collaborators was Dr. Ian D. Peggs, who authored the 2008 article cited by the Agency on the effects of UV exposure on geomembrane liners.

CCR and water until 2019. As documented in the annual inspections performed for the pond between 2016 and 2019, the Station historically operated Pond 2 such that the water level was at the elevation of the pond's outlet weir. See Att. 11. Per Section V on Drawing 5079-C-5019 in Att. 4, the weir crest is at EL. 532.85 feet. Per the 2008 as-built topographic survey of Pond 2, the crest elevation of Pond 2 is generally at or about EL. 535.00 feet. See Att. 5. Therefore, only about two feet of Pond 2's geomembrane liner has had prolonged exposure to the elements since the liner was installed in 2008.

Based on the aforementioned UV degradation results presented in GRI's White Paper #6 and the increased durability of textured white HDPE geomembranes compared to smooth black HDPE geomembranes, it is my opinion that Pond 2's existing HDPE geomembrane liner has not had enough prolonged exposure to the elements to expect UV degradation has occurred to compromise the liner's structural integrity. Also, given that the liner was installed circa spring 2008, and based on the aforementioned test results presented in GRI White Paper #6, Pond 2's liner would be expected to have at least 22 more years of service life before issues related to UV degradation may manifest in the exposed portions of the liner. However, in my opinion, the 36-year service life for the Pond 2 liner is conservatively low because of the cooler temperatures observed in white and textured geomembranes compared to black and smooth geomembranes and the known link between cooler temperatures and geomembrane durability, as well as the fact that only the upper few feet of the liner have had prolonged exposure to the elements since it was installed.

## Conclusion

Based on the information presented in the preceding sections; in the attached design, construction, photographic, and subsurface investigation records for Pond 2; and in the attached studies and research papers, it is my opinion that:

- MWG did not use CCR as fill material when preparing the subgrade for Pond 2's new HDPE geomembrane liner in 2008.
- The material observed along the pond floor in circa April 2008 photographs prior to installation of the pond's HDPE geomembrane liner is fill material leftover from cutting Pond 2's embankments back to form shallower side slopes that was then spread along the pond floor, than evidence that the pond's original Poz-O-Pac liner has deteriorated.
- Pond 2's existing HDPE geomembrane liner has not been in service long enough for prolonged exposure to the elements to expect UV degradation has occurred to compromise the liner's structural integrity.
- It is unlikely that Pond 2's existing HDPE geomembrane liner has sustained punctures from the overlying sand cushion and gravel warning layers or the underlying subgrade when the pond was in service given the presence of the non-woven geotextiles above and below the liner. Therefore, integrity testing recommended by the Agency for identifying punctures in the liner is not warranted.

Respectfully submitted,

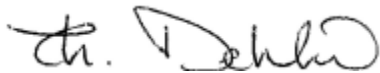

Thomas J. Dehlin, P.E.

# **ATTACHMENT 1**

**PHOTOGRAPH P-1 (TAKEN APRIL 30, 2008 BY OTHERS)  
LOOKING NORTHEAST AT INSTALLATION OF GEOTEXTILE  
CUSHION AND GEOMEMBRANE LINER ON INTERIOR SLOPE  
OF POND 2'S EASTERN EMBANKMENT**

**d, Clerk's Office 3/24/2022**

**WHITE HDPE  
GEOMEMBRANE  
LINER**

**NON-WOVEN  
GEOTEXTILE**

**ASSUMED AREA WITH BLACK  
SILTY GRAVEL ON POND 2'S  
SIDE SLOPE IDENTIFIED BY  
AGENCY**

**APPARENT TOP OF  
ORIGINAL POZ-O-  
PAC LINER**

**MARKER POST**

**PHOTOGRAPH P-2**





PHOTOGRAPH P-2 (TAKEN APRIL 30, 2008 BY OTHERS)  
LOOKING NORTHEAST AND DOWN AT BASE OF  
MARKER POST IN FOREGROUND OF PHOTOGRAPH P-1

received, Clerk's Office 3/24/2022

APPARENT TOP OF  
ORIGINAL POZ-O-  
PAC LINER

DARK BROWN SAND AND /OR  
GRAVEL MATERIAL (I.E., NOT  
CCR).  
NOTE: IN MY PROFESSIONAL  
OPINION, THE COLOR SHOWN  
IN THIS PHOTOGRAPH IS  
RELATED TO MOISTURE  
CONTENT.

MARKER POST SHOWN  
IN PHOTOGRAPH P-1

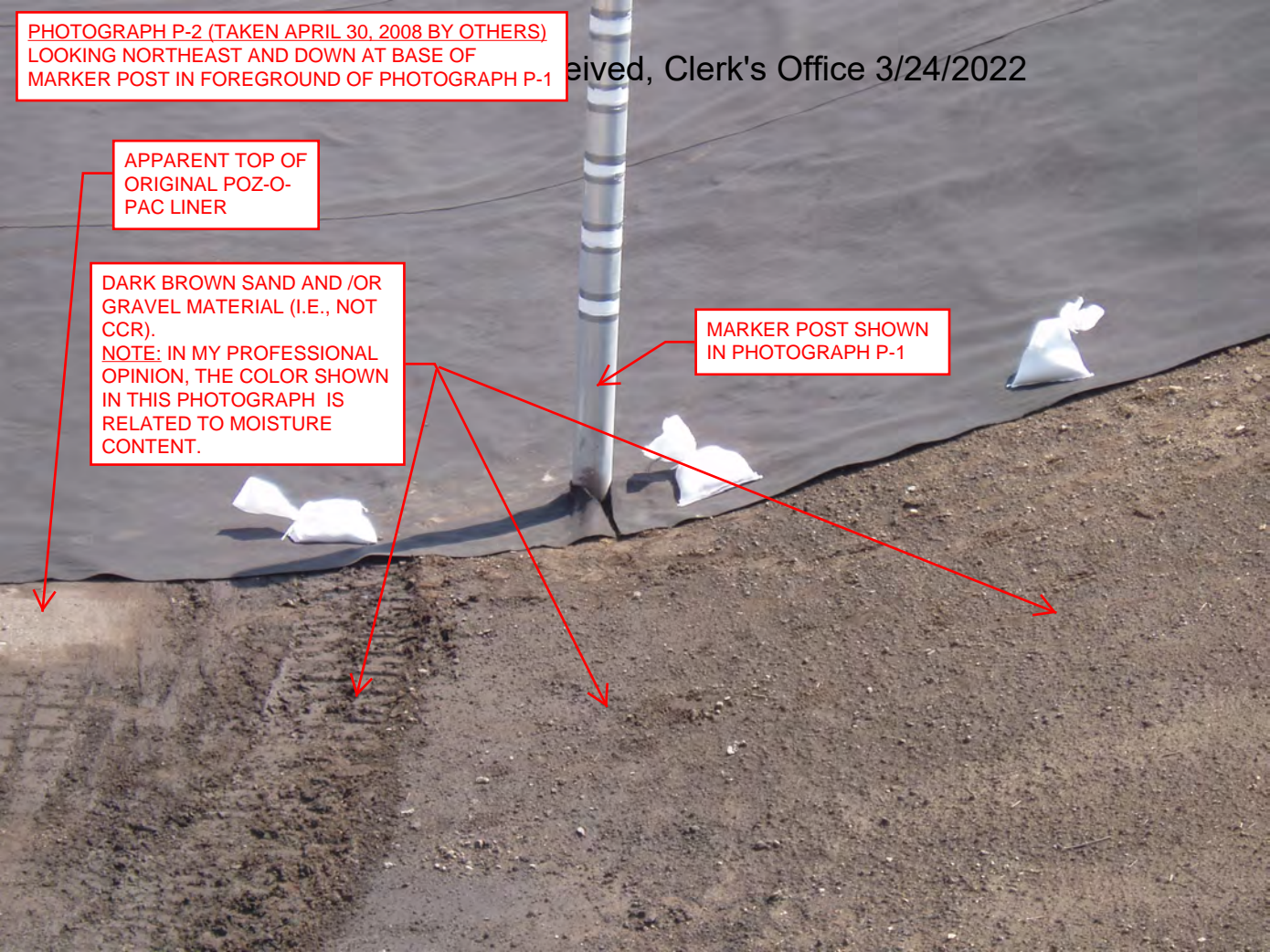



PHOTOGRAPH P-3 (TAKEN APRIL 28, 2008 BY OTHERS)  
LOOKING NORTHEAST AT POND 2'S FINISHED  
SUBGRADE, WHICH IS BEING INSPECTED FOR  
APPROVAL TO RECEIVE NEW GEOMEMBRANE LINER

NORTHEASTERN/  
EASTERN CORNER OF  
POND 2 REGRADED  
FROM 1H:1V SLOPE TO  
3H:1V SLOPE

3/24/2022

DARK BROWN SAND,  
GRAVEL AND / OR CLAY  
MATERIAL (I.E., NOT CCR)

STANDING WATER ON  
POND FLOOR FROM  
PRIOR PRECIPITATION



# **ATTACHMENT 2**

**HYDROGEOLOGIC ASSESSMENT REPORT  
JOLIET GENERATING STATION No. 29  
JOLIET, ILLINOIS**

**SUBMITTED BY:  
MIDWEST GENERATION, LLC  
235 REMINGTON BLVD, SUITE A  
BOLINGBROOK, ILLINOIS 60440**

**SUBMITTED TO:  
ILLINOIS ENVIRONMENTAL PROTECTION AGENCY  
1021 N GRAND AVENUE EAST  
SPRINGFIELD, ILLINOIS 62702**

**PREPARED BY:  
PATRICK ENGINEERING INC.  
4970 VARSITY DRIVE  
LISLE, ILLINOIS 60532**

**PATRICK PROJECT No. 21053.070**

**FEBRUARY 2011**



**TABLE OF CONTENTS**

**1.0 INTRODUCTION.....1**  
    **1.1 Background .....1**  
    **1.2 Site Location and Description.....1**  
    **1.3 Regional Setting .....1**

**2.0 HYDROGEOLOGIC ASSESSMENT METHODOLOGY .....3**  
    **2.1 Evaluation of Ash-Related Constituent Migration Potential.....3**  
        2.1.1 Installation of Groundwater Monitoring Wells.....2  
        2.1.2 Initial Groundwater Sampling and Analytical Testing .....4  
    **2.2 Characterization of Subsurface Hydrogeology .....5**  
        2.2.1 Site Lithology.....5  
        2.2.2 Topographic and Water Elevation Surveys.....5  
        2.2.3 Hydraulic Testing of Selected Wells.....5  
    **2.3 Identification of Potable Well Use .....6**

**3.0 HYDROGEOLOGIC ASSESSMENT RESULTS.....7**  
    **3.1 Evaluation of Ash-Related Constituent Migration Potential.....7**  
    **3.2 Characterization of Subsurface Hydrogeology .....7**  
    **3.3 Identification of Potable Well Use .....8**

**4.0 LONG-TERM MONITORING PLAN .....9**

**TABLES**

- Table 1 – Groundwater Field Parameter Data
- Table 2 – Groundwater Analytical Results
- Table 3 – Groundwater Elevation Survey Data

**FIGURES**

- Figure 1 – Site Location Map
- Figure 2 – Ash Pond Locations Map
- Figure 3 – Monitoring Well Location Map
- Figure 4 – Cross Section A-A’
- Figure 5 – Potentiometric Surface Map

**APPENDICES**

- Appendix A – Soil Boring Logs
- Appendix B – Figure - Potable Wells Within 2,500 Feet (NRT – July 2009)
- Appendix C – Laboratory Analytical Reports
- Appendix D – Hydraulic Conductivity Testing Data



## **1.0 INTRODUCTION**

### **1.1 Background**

Pursuant to the request of the Illinois Environmental Protection Agency (Illinois EPA), this document presents the Hydrogeologic Assessment Report for the on-site ash pond areas at the Midwest Generation, LLC (MWG) Joliet Generating Station No. 29 in Joliet, Illinois. This hydrogeologic assessment was performed in accordance with the Hydrogeologic Assessment Plan, approved by the Illinois EPA, dated September 3, 2010.

As defined by the Hydrogeologic Assessment Plan, the purpose of this investigation was to: (i) evaluate the potential, if any, for migration of ash-related constituents from the on-site ash ponds and to conduct monitoring for groundwater constituents regulated by the Illinois Part 620 groundwater standards, as requested by the Illinois EPA; (ii) characterize the subsurface hydrogeology; and (iii) identify potable well use within 2,500 feet of the ash ponds. The results of this investigation are described in this Hydrogeologic Assessment Report.

### **1.2 Site Location and Description**

The Joliet No. 29 facility (the Site) is located in Section 19, Township 35 North, Range 10 East, in the City of Joliet, Will County, Illinois. Figure 1 provides a Site Location Map.

The Site includes three active ash ponds (Ash Pond 1, Ash Pond 2, and Ash Pond 3). Two of the ponds are lined with a high-density polyethylene (HDPE), while the third is lined with 12" of geo-composite material on the bottom; the total area of the three ash ponds is approximately 10 acres. Figure 2 shows the locations of the three ash ponds.

### **1.3 Regional Setting**

The Site is located along the Des Plaines River just to the south of the city of Joliet. The surrounding land use is almost entirely industrial with some parcels of undeveloped land. It is important to note that industrial properties are located hydraulically upgradient of the Site.



Hydrogeologic Assessment Report  
Joliet Generating Station No. 29  
Midwest Generation, LLC  
Illinois Environmental Protection Agency  
February 28, 2011  
21053.070  
Page 2 of 9

Patrick Engineering Inc. (Patrick) conducted a review of publically available geological information from the Illinois State Geological Survey website. Based upon water well logs from the area, the geology beneath the Site consists of approximately 5-30 feet of sandy loam, underlain by Silurian Dolomite to approximately 176 feet below ground surface, and Maquoketa shale from approximately 176 to 241 feet below ground surface. The Maquoketa shale is generally considered to be an aquitard that separates the shallow groundwater in the unconsolidated units and the Silurian dolomite from the underlying aquifers.

Groundwater flow in the shallow, unconsolidated aquifer should be largely controlled by the Des Plaines River with groundwater flowing towards the river during most periods of the year. Groundwater flow in the deeper aquifers is controlled by the regional hydraulic gradient in these aquifers, which is to the northeast. The Site lies within the Joliet Depression, which is a cone of depression of the groundwater surface caused by the large withdrawals of the groundwater from the deeper aquifers due to industrial and municipal use in the area.





## **2.0 HYDROGEOLOGIC ASSESSMENT METHODOLOGY**

The following sections present the methodologies used to evaluate the potential for migration of ash-related constituents from the ash ponds and to monitor for all Part 620-regulated constituents, to characterize the subsurface hydrogeology, and to identify potable well use within 2,500 feet of the Site.

### **2.1 Evaluation of Ash-Related Constituent Migration Potential**

The Illinois EPA requested that an evaluation of the potential for migration of ash-related constituents from the ash ponds and that monitoring for all Part 620-regulated constituents be performed in accordance with the groundwater standards included in 35 Illinois Administrative Code (IAC) Part 620, Subparts C and D. Accordingly, groundwater monitoring wells were installed at the Site in locations both upgradient and downgradient of the three ash ponds.

#### **2.1.1 Installation of Groundwater Monitoring Wells**

Patrick installed eleven (11) groundwater monitoring wells spaced approximately 150 to 300 feet apart around the perimeter of the ash ponds. The well locations were selected so that both upgradient and downgradient wells were represented, based upon available data regarding the expected groundwater flow direction. The spacing of the well locations at the Site along the downgradient edge of the ash ponds was calculated so as to detect a groundwater plume emanating from a point source beneath the ash ponds. Figure 3 shows the location of the eleven monitoring wells.

Three of the installed monitoring wells are located upgradient of the ash ponds; the additional eight wells are located downgradient of the ash ponds. The well borings were advanced using hollow-stem augers to depths ranging from 27.5 to 42 feet below ground surface (bgs). Borings were terminated after the field geologist determined that the boring was installed approximately 10 feet past the first intersection of the groundwater table in order to ensure that a representative



Hydrogeologic Assessment Report  
Joliet Generating Station No. 29  
Midwest Generation, LLC  
Illinois Environmental Protection Agency  
February 28, 2011  
21053.070  
Page 4 of 9

groundwater sample could be obtained. Upon termination of each boring, a 2-inch diameter, PVC well was installed in order to collect samples of the groundwater in the uppermost aquifer. The monitoring wells were completed to approximately 3 feet above grade, with PVC casing, and were covered with a stick-up, steel well protector with a locking cap. Soil lithology was inspected and logged by an experienced geologist during the boring process. Boring logs with well construction information are included as Appendix A.

#### 2.1.2 Initial Groundwater Sampling and Analytical Testing

The groundwater sampling event for the Site took place on December 6, 2010. The groundwater elevation in each of the eleven wells was measured prior to sampling. For all but one of the eleven wells, MW-09, the depth to groundwater was outside the effective range of the peristaltic pump. Groundwater samples were collected from MW-09 with a peristaltic pump, using established low-flow sampling techniques. For the remaining ten (10) wells, groundwater samples were collected using a disposable polyethylene bailer; a different bailer was used for each well to prevent cross-contamination. Each well was purged until at least three well volumes had been extracted or until the groundwater was observed to be clear. Groundwater was then baled into a decontaminated, stainless steel container and thereafter transferred to the sampling containers via peristaltic pump. Temperature, pH, and conductivity measurements were taken using a portable meter in all wells; refer to Table 1 for these field parameter results. All groundwater samples were filtered in the field using a disposable, 0.45 $\mu$ m, in-line filter to allow for the analytical testing of dissolved compounds. The samples were immediately placed on ice in a cooler and kept at a temperature no higher than 4° F. The samples were transported to TestAmerica, an Illinois-EPA accredited analytical laboratory, in accordance with chain-of-custody procedures to maintain the integrity of the samples.

The analytical laboratory tested groundwater samples from each of the wells for the compounds listed in Table 2. Analytes tested include the inorganic compounds listed in 35 IAC 620.410(a), excluding both radium and the poly-aromatic hydrocarbons (PAHs) listed in 35 IAC 620.410(b).



## **2.2 Characterization of Subsurface Hydrogeology**

The subsurface hydrogeology beneath the ash ponds was characterized by determining Site lithology and the groundwater flow patterns in the vicinity of the ash ponds as described below.

### **2.2.1 Site Lithology**

The Site lithology was determined by logging soil samples collected from the soil borings created during the installation of the groundwater monitoring wells. The soil borings were installed under the direction of an experienced geologist. Each boring was sampled at 2-foot intervals using a 2-inch O.D. split-spoon sampler (ASTM D 1586). Each soil sample was inspected and logged by the geologist during the boring process. Boring logs with well construction information are provided as Appendix A.

### **2.2.2 Topographic and Water Elevation Surveys**

A survey crew measured both the top-of-casing and ground surface elevations of all installed monitoring wells and the groundwater elevations within each of the monitoring wells on December 6, 2010. The survey crew concurrently measured the water elevation in two of the three of the ash ponds and the Des Plaines River. The water surface of Ash Pond 2 was inaccessible the day of the survey due to a low water elevation in the pond. However, the remaining groundwater elevation data collected from the Site was sufficient in determining groundwater flow characteristics for the purposes of this assessment.

### **2.2.3 Hydraulic Testing of Selected Wells**

Patrick conducted four *in situ* hydraulic conductivity tests on wells MW-4, MW-6, MW-9, and MW-11 on December 21, 2010. The testing consisted of one rising-head and one falling-head slug test performed at each well. Using a data-logging pressure transducer, Patrick measured the rate of groundwater level recovery in the wells after either inserting a slug into, or removing a slug from, each monitoring well.



Hydrogeologic Assessment Report  
Joliet Generating Station No. 29  
Midwest Generation, LLC  
Illinois Environmental Protection Agency  
February 28, 2011  
21053.070  
Page 6 of 9

### **2.3 Identification of Potable Well Use**

Natural Resource Technology, Inc. (NRT) has previously completed an investigation of potable water well use within 2,500 feet of the Joliet No. 29 ash ponds. MWG submitted the results of this investigation to the Illinois EPA by letter dated July 15, 2009. These results are summarized in Appendix B.

The following databases and sources of information were used in order to identify local community water sources and water well locations in the vicinity of the Site:

- Illinois State Geological Survey (ISGS) -Water Well Database Query;
- Illinois State Water Survey (ISWS) Private Well Database and water well construction report request; and
- Illinois Division of Public Water Supply web-based Geographic System (GIS) files.



## **3.0 HYDROGEOLOGIC ASSESSMENT RESULTS**

### **3.1 Evaluation of Ash-Related Constituent Migration Potential**

The analytical laboratory results for the hydrogeologic assessment are presented in Table 2. Full laboratory data packages from TestAmerica are provided as Appendix C. Antimony, chloride, manganese, sulfate, and total dissolved solids (TDS) were detected in one or more monitoring wells at concentrations exceeding the Part 620 Class I Groundwater Quality Standards. In some cases, the highest concentrations of a given compound were found in the upgradient wells. Beryllium, cadmium, chromium, cyanide, iron, lead, mercury, silver, thallium, zinc, and nitrogen/nitrite were not detected in any of the groundwater samples.

A determination of the potential for the individual ash ponds to be contributing to the distribution of analytes in the underlying groundwater and the extent, if any, of such contribution cannot be made from the results of this single sampling event alone. To develop a true, statistically-significant upgradient background concentration for the various compounds will require a number of sequential sampling events over time. Based on a statistically-developed background value, downgradient concentrations can be compared to the background value over time to determine the likelihood and extent of any constituent migration from the on-site ash ponds. A plan to develop such an analytical database through additional sampling is presented in the last section of this report.

### **3.2 Characterization of Subsurface Hydrogeology**

The lithology of the Site is predominantly sand and gravel with intermittent seams of clay and gravel. Auger refusal was encountered throughout the Site at depths ranging from 35 to 42 feet below ground surface. Split spoon samples from these depth returned fragments of limestone, indicating the top of the bedrock layer. Refer to Figure 4 for a geologic cross-section of the Site.

The results of the topographic and water elevation surveys are presented in Table 3.



The uppermost groundwater unit at the Site is found at depths ranging from 29 to 34 feet bgs. The direction of groundwater flow is to the south towards the Des Plaines River, which runs along the southern boundary of the Site. The hydraulic gradient is approximately 0.0009 based upon the groundwater elevation data collected on December 6, 2010. A potentiometric surface map is provided as Figure 5.

Patrick used the hydraulic testing data to calculate the hydraulic conductivity of the uppermost aquifer using the Bouwer and Rice method. Hydraulic conductivity calculations are provided in Appendix D. The hydraulic conductivity of Site soils ranged from  $1.948 \times 10^{-3}$  to  $6.949 \times 10^{-3}$  ft/second. The average hydraulic conductivity was  $3.896 \times 10^{-3}$  ft/second. Using the highest calculated hydraulic conductivity and the measured hydraulic gradient, Patrick calculated the maximum groundwater velocity to be approximately 0.30 ft/day ( $3.896 \times 10^{-3}$  ft/sec x 0.0009 x 60 sec/min x 60 min/hour x 24 hours/day).

### **3.3 Identification of Potable Well Use**

As stated above, NRT has previously completed an investigation of potable water well use within 2,500 feet of the Joliet No. 29 ash ponds. MWG submitted the results of this investigation to the Illinois EPA by letter dated July 15, 2009. According to this letter, seventeen potable/industrial use wells are located within a 2,500-foot radius of the Site's ash ponds (refer to Appendix B.) However, most of these wells are screened in much deeper aquifers. Only two of the wells (Numbers 19 and 4) are located downgradient from the ash impoundments. Both of these industrial use wells are owned by MWG, and are drilled at 1,525 feet below ground surface and are screened below the Maquoketa shale, a significant aquitard separating shallower aquifers from the screened interval of the MWG wells.





Hydrogeologic Assessment Report  
Joliet Generating Station No. 29  
Midwest Generation, LLC  
Illinois Environmental Protection Agency  
February 28, 2011  
21053.070  
Page 9 of 9

## **4.0 LONG-TERM MONITORING PLAN**

In order to properly assess the groundwater monitoring data collected in this single sampling event, MWG will conduct a quarterly groundwater sampling program in which the same monitoring wells described in this report will be sampled for the identical analyte list employed during this investigation. MWG proposes to begin this quarterly monitoring program in March 2011, and will submit the results of the sampling program to the Illinois EPA on an ongoing, quarterly basis. MWG proposes to continue this program until sufficient statistically-significant data is available to properly assess the groundwater data. If the quarterly sampling results continue to show non-detect results for certain of the analytes, as was the case in this single sampling event, MWG may propose to Illinois EPA that these analytes be eliminated from future sampling events.

GROUNDWATER FIELD PARAMETER DATA

Joliet #29 Station, Joliet, Illinois

Midwest Generation

21053.070

Feb. 28, 2011

 <b>Groundwater Field Parameter Data - Joliet # 29 Station</b>					
Monitoring Well	Date	Time	Conductance (S/cm)*	Temperature °C	pH
MW-01	12/6/2010	14:20	1.04	7.52	7.82
MW-02	12/6/2010	13:41	1.10	9.30	7.85
MW-03	12/6/2010	10:14	7.83	10.91	7.84
MW-04	12/6/2010	10:55	1.84	10.69	7.71
MW-05	12/6/2010	11:40	1.36	8.86	7.82
MW-06	12/6/2010	9:26	1.20	8.53	8.04
MW-07	12/6/2010	8:53	2.12	9.72	8.08
MW-08	12/6/2010	14:52	1.17	12.70	7.75
MW-09	12/6/2010	11:00	2.97	11.94	7.03
MW-09	12/6/2010	11:03	2.93	12.57	6.99
MW-09	12/6/2010	11:06	2.94	12.51	6.97
MW-09	12/6/2010	11:09	2.97	12.24	7.01
MW-09	12/6/2010	11:12	2.99	11.57	7.03
MW-10	12/6/2010	15:17	1.51	9.26	7.65
MW-11	12/6/2010	15:54	1.32	11.97	7.72

Notes:

\* (S/cm) = Specific Conductivity measured in Seconds/Centimeters

Electronic Filing: Received, Clerk's Office 3/24/2022

GROUNDWATER ANALYTICAL RESULTS

Joliet Station #29, Illinois

Midwest Generation

21053.070

February 28, 2011

 <b>PATRICK</b> <b>ENGINEERING</b>	Sample Analysis Method	Groundwater Remediation Objective (mg/L) Class I*	MW-1	MW-2	MW-3	MW-4	MW-5	MW-6	MW-7
			mg/L	mg/L	mg/L	mg/L	mg/L	mg/L	mg/L
Chemical Name			12/6/10	12/6/10	12/7/10	12/7/10	12/7/10	12/7/10	12/7/10
Antimony	Metals 6020	0.006	0.0043	<b>0.012</b>	0.004	ND	ND	ND	ND
Arsenic	Metals 6020	0.05	0.0011	ND	ND	ND	ND	ND	0.001
Barium	Metals 6020	2.0	0.13	0.082	0.089	0.065	0.061	0.075	0.13
Beryllium	Metals 6020	0.004	ND	ND	ND	ND	ND	ND	ND
Cadmium	Metals 6020	0.005	ND	ND	ND	ND	ND	ND	ND
Chromium	Metals 6020	0.1	ND	ND	ND	ND	ND	ND	ND
Cobalt	Metals 6020	1.0	ND	ND	0.0013	ND	ND	ND	ND
Copper	Metals 6020	0.65	0.0032	0.0032	ND	ND	ND	ND	ND
Cyanide	Dissolved 9014	0.2	ND	ND	ND	ND	ND	ND	ND
Iron	Metals 6020	5.0	ND	ND	ND	ND	ND	ND	ND
Lead	Metals 6020	0.0075	ND	ND	ND	ND	ND	ND	ND
Manganese	Metals 6020	0.15	ND	ND	0.1	<b>0.33</b>	0.0065	0.14	<b>0.29</b>
Mercury	Mercury 7470A	0.002	ND	ND	ND	ND	ND	ND	ND
Nickel	Metals 6020	0.1	0.0034	0.0033	0.011	0.0067	ND	0.0056	0.0045
Selenium	Metals 6020	0.05	ND	ND	ND	0.0025	ND	0.0029	ND
Silver	Metals 6020	0.05	ND	ND	ND	ND	ND	ND	ND
Thallium	Metals 6020	0.002	ND	ND	ND	ND	ND	ND	ND
Zinc	Metals 6020	5.0	ND	ND	ND	ND	ND	ND	ND
Boron	Metals 6020	2	0.31	0.31	0.24	0.46	0.42	0.32	0.51
Sulfate	Dissolved 9038	400	180	190	120	300	110	140	250
Chloride	Dissolved 9251	200	140	140	<b>260</b>	<b>270</b>	150	130	<b>430</b>
Nitrogen/Nitrate	Nitrogen By calc	10	ND	3.1	ND	0.81	ND	ND	ND
Total Dissolved Solids	Dissolved 2540C	1,200	590	600	930	1100	750	650	1200
Fluoride	Dissolved 4500 FC	4	0.45	0.62	0.43	0.49	0.4	0.4	0.36
Nitrogen/Nitrite	Dissolved 4500 NO2	NA	ND	ND	ND	ND	ND	ND	ND
Nitrogen/Nitrate/Nitrite	Dissolved 4500 NO3	NA	1.9	3.1	ND	0.81	ND	ND	ND

Notes:

Class I Groundwater Standards from 35 IAC Part 620

Bold Values areas exceed groundwater objectives

mg/L = Milligrams per Liter

ND-non detect

-Determination of the potential for the individual ash ponds to be contributing to the distribution of analytes in the underlying groundwater cannot be made from the results of this single sampling event alone. To develop a true, statistically-significant upgradient background concentration for the various compounds will require a number of sequential sampling events over time. After a statistically developed background value is available, the downgradient concentrations can be compared to this background value over time to determine the likelihood of contaminant migration from the on-site ash ponds. A plan to develop such an analytical database through additional sampling is discussed in the last section of this report.

Electronic Filing: Received, Clerk's Office 3/24/2022  
 GROUNDWATER ANALYTICAL RESULTS

Joliet Station #29, Illinois  
 Midwest Generation  
 21053.070  
 February 28, 2011

 <b>PATRICK ENGINEERING</b>	Sample Analysis Method	Groundwater Remediation Objective (mg/L)	MW-8	MW-9	MW-10	MW-11
		Class I*	mg/L 12/6/10	mg/L 12/6/10	mg/L 12/6/10	mg/L 12/6/10
Chemical Name						
Antimony	Metals 6020	0.006	ND	ND	ND	ND
Arsenic	Metals 6020	0.05	ND	ND	ND	0.0013
Barium	Metals 6020	2.0	0.0054	0.031	0.05	0.064
Beryllium	Metals 6020	0.004	ND	ND	ND	ND
Cadmium	Metals 6020	0.005	ND	ND	ND	ND
Chromium	Metals 6020	0.1	ND	ND	ND	ND
Cobalt	Metals 6020	1.0	ND	0.0047	ND	ND
Copper	Metals 6020	0.65	ND	ND	ND	ND
Cyanide	Dissolved 9014	0.2	ND	ND	ND	ND
Iron	Metals 6020	5.0	ND	ND	ND	ND
Lead	Metals 6020	0.0075	ND	ND	ND	ND
Manganese	Metals 6020	0.15	0.0051	<b>1.1</b>	0.12	0.052
Mercury	Mercury 7470A	0.002	ND	ND	ND	ND
Nickel	Metals 6020	0.1	0.0025	0.0094	0.0052	0.0022
Selenium	Metals 6020	0.05	ND	ND	ND	ND
Silver	Metals 6020	0.05	ND	ND	ND	ND
Thallium	Metals 6020	0.002	ND	ND	ND	ND
Zinc	Metals 6020	5.0	ND	ND	ND	ND
Boron	Metals 6020	2	0.29	0.36	0.5	0.47
Sulfate	Dissolved 9038	400	210	<b>1600</b>	130	140
Chloride	Dissolved 9251	200	130	140	<b>200</b>	160
Nitrogen/Nitrate	Nitrogen By calc	10	0.33	ND	0.39	0.39
Total Dissolved Solids	Dissolved 2540C	1,200	670	<b>2600</b>	860	770
Fluoride	Dissolved 4500 FC	4	0.51	0.61	0.43	0.34
Nitrogen/Nitrite	Dissolved 4500 NO2	NA	ND	ND	ND	ND
Nitrogen/Nitrate/Nitrite	Dissolved 4500 NO3	NA	0.33	ND	0.39	0.39

Notes:

Class I Groundwater Standards from 35 IAC Part 620  
 Bold Values areas exceed groundwater objectives  
 mg/L = Milligrams per Liter  
 ND-non detect

-Determination of the potential for the individual ash ponds to be contributing to the distribution of analytes in the underlying groundwater cannot be made from the results of this single sampling event alone. To develop a true, statistically-significant upgradient background concentration for the various compounds will require a number of sequential sampling events over time. After a statistically developed background value is available, the downgradient concentrations can be compared to this background value over time to determine the likelihood of contaminant migration from the on-site ash ponds. A plan to develop such an analytical database through additional sampling is discussed in the last section of this report.

Electronic Filing: Received, Clerk's Office 3/24/2022

GROUNDWATER ELEVATION SURVEY DATA

Joliet #29 Station, Joliet, Illinois

Midwest Generation

21053.070

Feb. 28, 2011

 PATRICK ENGINEERING	Water Elevation (feet)	Depth to Water (feet bgs)	Lid Elevation (feet)	Ground Elevation (feet)	Top of Riser Elevation (feet)
<b>MONITORING WELLS</b>					
MW-1	505.460	29.30	535.222	531.464	534.760
MW-2	505.083	29.20	534.799	531.186	534.283
MW-3	505.082	33.70	539.255	535.540	538.782
MW-4	504.926	34.10	539.503	535.800	539.026
MW-5	504.987	34.70	540.149	536.428	539.687
MW-6	505.061	34.00	539.550	535.858	539.061
MW-7	505.050	34.30	539.792	535.862	539.350
MW-8	505.173	31.70	537.347	533.720	536.873
MW-9	505.238	29.20	534.941	531.126	534.438
MW-10	505.227	34.80	540.532	536.949	540.027
MW-11	505.173	34.30	539.960	536.521	539.473
<b>ASH PONDS</b>					
East Pond	530.127	NS	NS	NS	NS
Mid Pond	NS	NS	NS	NS	NS
West Pond	533.112	NS	NS	NS	NS
<b>RIVER</b>					
Des Plaines River	504.827	NS	NS	NS	NS

Notes:

\*Survey data taken on 12/6/10

NS = not surveyed

bgs = below ground surface

Elevations are leveled from site control points per Commonwealth Edison Drawing

"Coordinates & Elevations for Coal Monuments & Test Borings-Joliet Station 29" revised



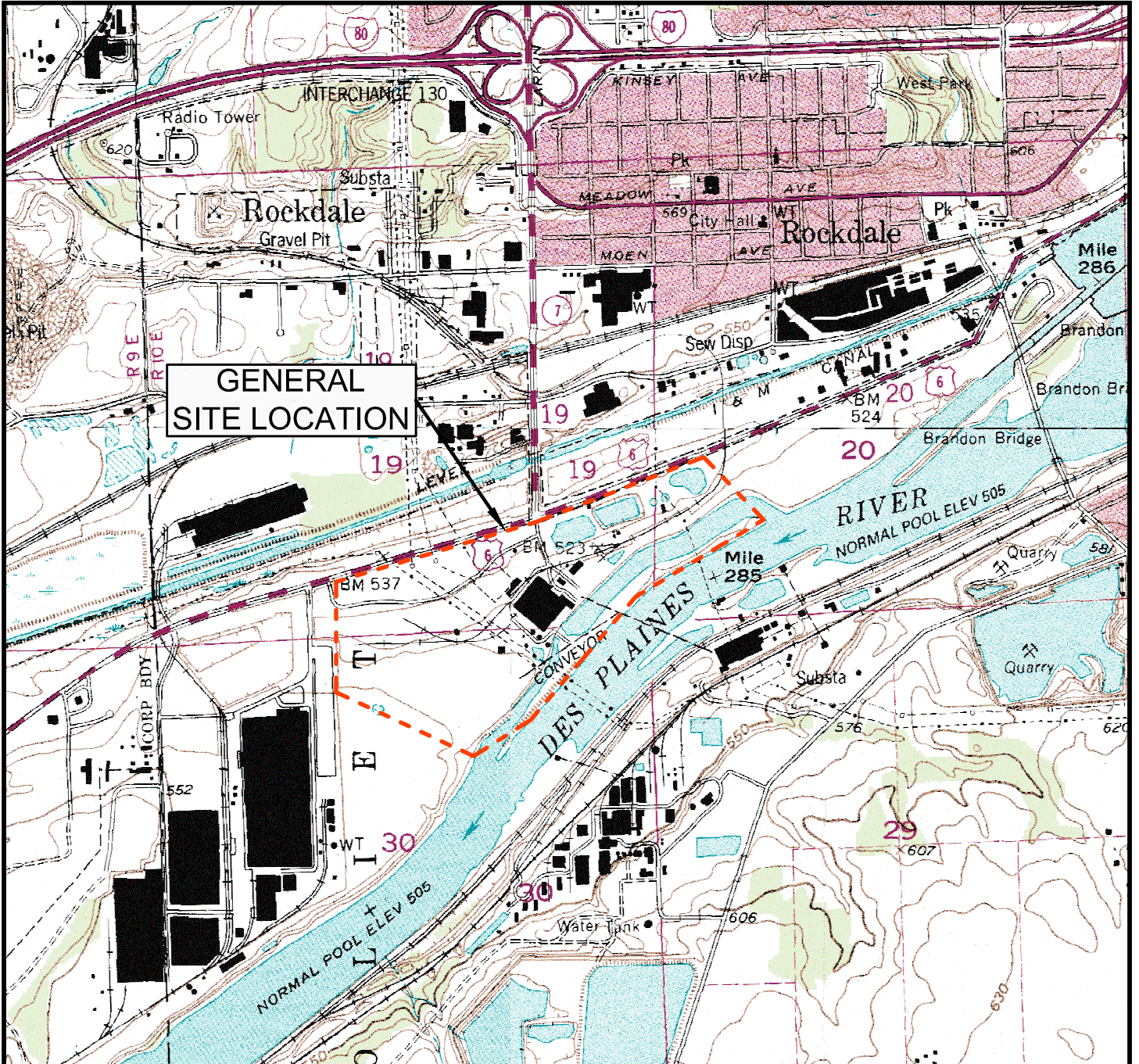

**LEGEND**

--- SITE BOUNDARY

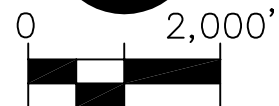
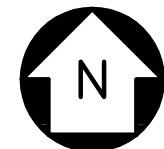

GRAPHIC SCALE

NOTE:  
THIS DRAWING WAS PREPARED USING ILLINOIS' PLAINFIELD (1993), JOLIET (1993), CHANNAHON (1993), AND ELWOOD (1993) 7.5 MINUTE-SERIES TOPOGRAPHIC QUADRANGLE MAP.

Date: FEB. 2011  
Proj No.: 21053.070  
App. By: RMF

**FIGURE 1  
SITE LOCATION MAP  
JOLIET STATION NO. 29  
JOLIET, ILLINOIS**

**PATRICK  
ENGINEERING INC.**

4970 Varsity Drive TEL. (630) 795-7200  
Lisle, Illinois 60532-4101 FAX (630) 724-1681  
PROFESSIONAL DESIGN FIRM LICENSE NO. 184-000409





LEGEND



ASH POND



GRAPHIC SCALE

AERIAL IMAGE SOURCE:  
LANDISCOR AERIAL INFORMATION INC., JULY 2008

Date: FEB. 2011

Proj No.: 21053.070

App. By: RMF

**FIGURE 2**  
**ASH POND LOCATIONS MAP**  
**JOLIET STATION NO. 29**  
**JOLIET, ILLINOIS**

**PATRICK**  
**ENGINEERING INC.**

4970 Varsity Drive  
Lisle, Illinois 60532-4101

TEL. (630) 795-7200  
FAX (630) 724-1681

PROFESSIONAL DESIGN FIRM LICENSE NO. 184-000409





LEGEND

 MW-01 Monitoring Well Location (November 2010)



GRAPHIC SCALE

AERIAL IMAGE SOURCE:  
LANDSCOR AERIAL INFORMATION INC., JULY 2008

Date: FEB. 2011

Proj No.: 21053.070

App. By: RMF

**FIGURE 3**  
**MONITORING WELL LOCATION MAP**  
**JOLIET STATION NO. 29**  
**JOLIET, ILLINOIS**

**PATRICK**  
**ENGINEERING INC.**

4970 Varsity Drive  
Lisle, Illinois 60532-4101





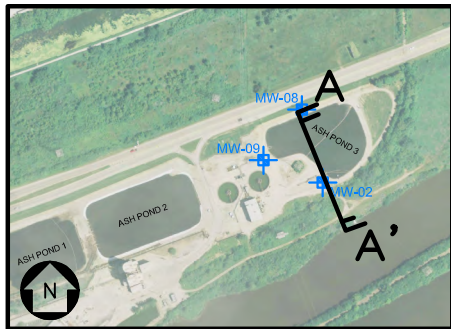
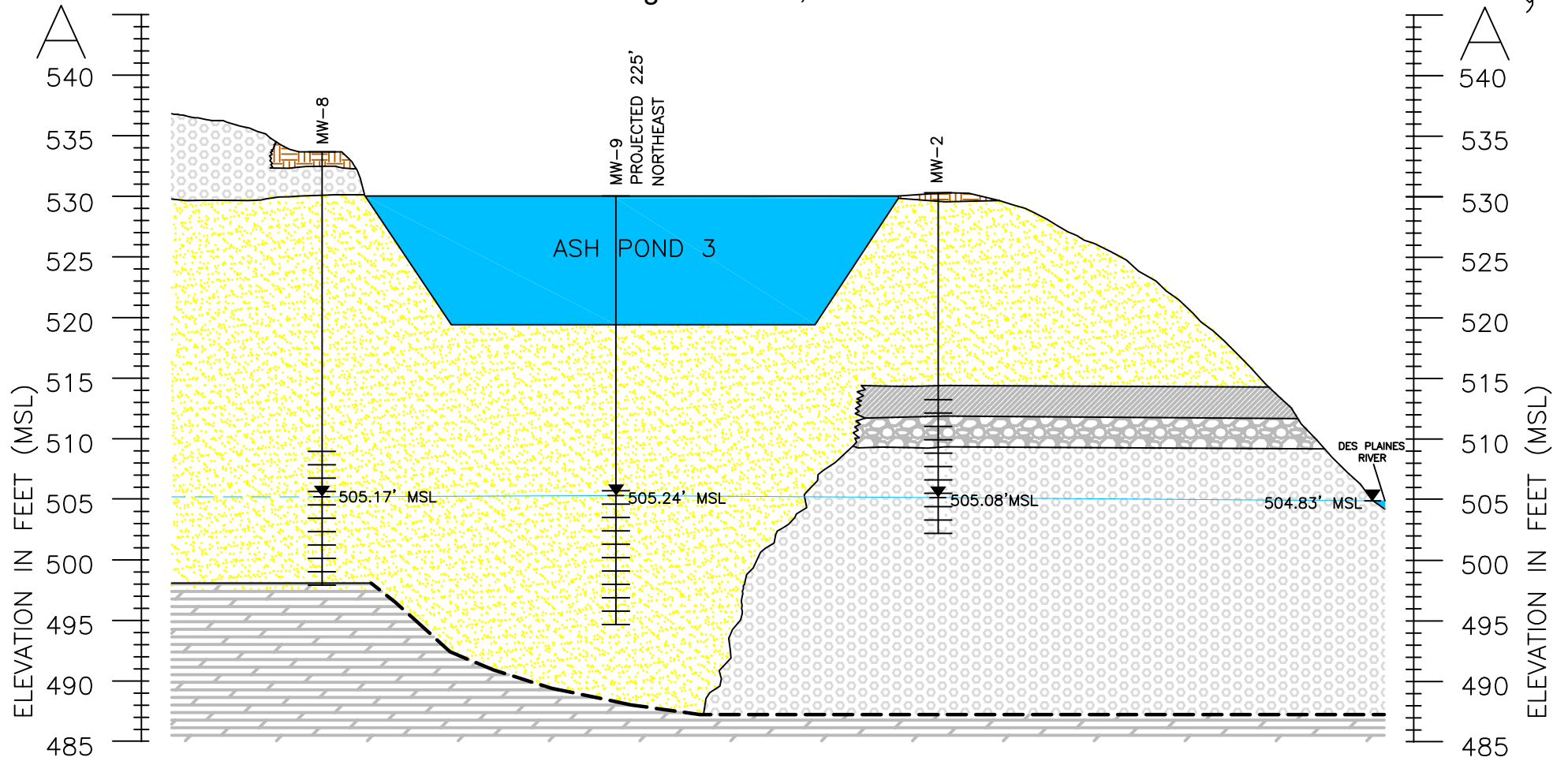

TEL. (630) 795-7200  
FAX (630) 724-1681

PROFESSIONAL DESIGN FIRM LICENSE NO. 184-000409



CROSS SECTION A-A'  
NOT TO SCALE

**LEGEND**

- |   |                                   |   |                     |
|---|-----------------------------------|---|---------------------|
|  | FILL                              |  | GRAVEL              |
|  | CLAYEY GRAVEL                     |  | SILTY CLAY          |
|  | SANDY GRAVEL                      |  | DOLOMITIC LIMESTONE |
|  | GROUNDWATER ELEVATION (FT. / MSL) |   |                     |

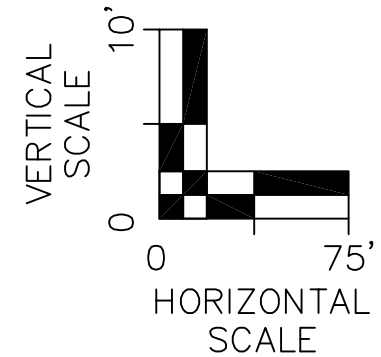

**PATRICK  
ENGINEERING INC.**

4970 Varsity Drive TEL. (630) 795-7200  
Liste, Illinois 60532-4101 FAX (630) 724-1681  
http://www.patrickengineering.com  
PROFESSIONAL DESIGN FIRM LICENSE NO. 184-000409

FIGURE 4  
CROSS SECTION A-A' - SITE LITHOLOGY

JOLIET STATION NO. 29  
JOLIET, ILLINOIS

DATE: FEBRUARY 2011



PROJ. NO.: 21053.070

APP. BY: RMF



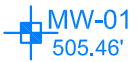

**LEGEND**

-  MW-01 505.46' Monitoring Well Location (November 2010) with Groundwater Elevation (ft. / MSL)
-  Groundwater Flow Direction
-  505.0 Potentiometric Surface Contour (ft. / MSL)

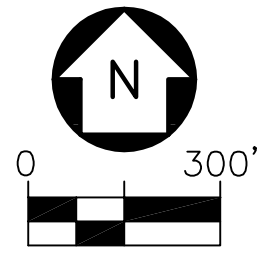



GRAPHIC SCALE

AERIAL IMAGE SOURCE:  
LANDSCOR AERIAL INFORMATION INC., JULY 2008

Date: FEB. 2011	<b>FIGURE 5</b> <b>POTENTIOMETRIC SURFACE MAP</b> <b>JOLIET STATION NO. 29</b> <b>JOLIET, ILLINOIS</b>	 4970 Varsity Drive Lisle, Illinois 60532-4101 TEL. (630) 795-7200 FAX (630) 724-1681 PROFESSIONAL DESIGN FIRM LICENSE NO. 184-000409
Proj No.: 21053.070		
App. By: RMF		

<b>PATRICK ENGINEERING INC.</b>	BORING NUMBER	<b>B-MW-1</b>	SHEET	<b>1 OF 2</b>	
	CLIENT	<b>Midwest Generation</b>			
	PROJECT & NO.	<b>21053.070</b>			
	LOCATION	<b>Joliet No. 29</b>			

LOGGED BY **AFG**  
 GROUND ELEVATION **531.5**

ELEVATION	DEPTH (FT)	STRATA	SOIL/ROCK DESCRIPTION	SAMPLE TYPE & NO. DEPTH (FT) RECOVERY(IN)	BLOW COUNTS	Water Content					NOTES & TEST RESULTS			
						PL	Unconfined Compressive Strength (TSF) *			LL				
						10	20	30	40	50				
531.5	0.0		Topsoil with fine to coarse gravel, moist											
			1' to 2' rounded coarse gravel at surface	SS-1 1.0-2.5 8"R	8 10 5							Bentonite seal 2.0'-14.0'. Stickup protective cover installed.		
			Fine to coarse sand and gravel, limestone fragments	SS-2 3.5-5.0 10"R	12 32 14									
			Limestone fragments, wet	SS-3 6.0-7.5 10"R	12 12 7									
				SS-4 8.5-10.0 0.5"	8 4 4									
520.5	11.0			Fine to coarse sand and gravel, some black clay, limestone fragments, wet	SS-5 11.0-12.5 8"R	5 5 5								
					SS-6 13.5-15.0 6"R	45 6 10								Sand pack 14.0'-26.25'
					SS-7 16.0-17.5 10"R	8 6 8								
514.5	17.0	▽ Saturated											Set screen (slot 0.010) 16.25'-26.25'	
				SS-8 18.5-20.0 6"R	14 10 11									
511.5	20.0		Limestone fragments, saturated											

DRILLING CONTRACTOR **Groff Testing**  
 DRILLING METHOD **4.25" I.D. HSA**  
 DRILLING EQUIPMENT **CME**  
 DRILLING STARTED **10/27/10** ENDED **10/27/10**

REMARKS  
**Installed 2" diameter PVC monitoring well.**

WATER LEVEL (ft.)  
 ▽ **17.0**  
 ▽ **15.0'**  
 ▼

**PATRICK ENGINEERING INC.**

BORING NUMBER **B-MW-1** SHEET **2 OF 2**  
 CLIENT **Midwest Generation**  
 PROJECT & NO. **21053.070**  
 LOCATION **Joliet No. 29**

LOGGED BY **AFG**  
 GROUND ELEVATION **531.5**

ELEVATION	DEPTH (FT)	STRATA	SOIL/ROCK DESCRIPTION	SAMPLE TYPE & NO. DEPTH (FT) RECOVERY(IN)	BLOW COUNTS	Water Content					NOTES & TEST RESULTS
						PL	Unconfined Compressive Strength (TSF) *			LL	
						10	20	30	40	50	
						1	2	3	4	5	
511.5	20.0	[Dotted pattern]	Fine to coarse sand and gravel, with limestone fragments, weathered, saturated	SS-9 21.0-22.5 8"R	22 25 13						
			Wet to saturated	SS-10 23.5-25.0 8"R	15 11 10						
			Saturated	SS-11 26.0-27.5 10"R	12 16 18						
504.0	27.5			End of Boring at 27.5'							

DRILLING CONTRACTOR **Groff Testing**  
 DRILLING METHOD **4.25" I.D. HSA**  
 DRILLING EQUIPMENT **CME**  
 DRILLING STARTED **10/27/10** ENDED **10/27/10**

REMARKS  
**Installed 2" diameter PVC monitoring well.**

WATER LEVEL (ft.)  
 ▽ 17.0  
 ▽ 15.0'  
 ▽



**PATRICK ENGINEERING INC.**

BORING NUMBER **B-MW-2** SHEET **1** OF **2**  
 CLIENT **Midwest Generation**  
 PROJECT & NO. **21053.070**  
 LOCATION **Joliet No. 29**

LOGGED BY **AFG**  
 GROUND ELEVATION **531.2**

ELEVATION	DEPTH (FT)	STRATA	SOIL/ROCK DESCRIPTION	SAMPLE TYPE & NO. DEPTH (FT) RECOVERY(IN)	BLOW COUNTS	Water Content					NOTES & TEST RESULTS		
						PL	Unconfined Compressive Strength (TSF) *			LL			
						10	20	30	40	50			
531.2	0.0		Fine to coarse gravel (CA-6)									1" - 6" cobbles at surface	
530.2	1.0		Brown fine to coarse sand and gravel, moist	SS-1 1.0-2.5 6"R	5 7 5								Bentonite seal 2.0'-14.0'. Stickup protective cover installed.
			1" limestone fragments	SS-2 3.5-5.0 0.5"R	8 12 6								
525.2	6.0		Brown fine to coarse sand and gravel, moist	SS-3 6.0-7.5 3"R	5 9 6								
			1" limestone fragments	SS-4 8.5-10.0 9"R	11 8 10								
			Little silty clay, moist to wet	SS-5 11.0-12.5 3"R	6 37 11								
517.7	13.5		Coarse gravel with black silty clay, trace roots, trace coarse sand, moist	SS-6 13.5-15.0 4"R	15 4 3							Sand pack 14.0'-26.5'	
515.2	16.0		Black silty clay, with fine to coarse sand and gravel, moist	SS-7 16.0-17.5 8"R	12 6 12								
512.7	18.5		Brown silty fine to coarse sand, trace fine gravel, saturated	SS-8 18.5-20.0 6"R	3 4 3							Set screen 16.5'-26.5'	

DRILLING CONTRACTOR **Groff Testing**  
 DRILLING METHOD **4.25" I.D. HSA**  
 DRILLING EQUIPMENT **CME**  
 DRILLING STARTED **10/29/10** ENDED **10/29/10**

REMARKS  
**Installed 2" diameter PVC monitoring well.**

WATER LEVEL (ft.)  
 ▽ **18.5**  
 ▽ **21.5'**  
 ▽





**PATRICK ENGINEERING INC.**

BORING NUMBER **B-MW-3** SHEET **2 OF 2**  
 CLIENT **Midwest Generation**  
 PROJECT & NO. **21053.070**  
 LOCATION **Joliet No. 29**

LOGGED BY **AFG**  
 GROUND ELEVATION **535.5**

ELEVATION	DEPTH (FT)	STRATA	SOIL/ROCK DESCRIPTION	SAMPLE TYPE & NO. DEPTH (FT) RECOVERY(IN)	BLOW COUNTS	Water Content					NOTES & TEST RESULTS
						PL	Unconfined Compressive Strength (TSF) *			LL	
						10	20	30	40	50	
						1	2	3	4	5	
514.5	21.0		Tan fine to coarse sand, with coarse gravel, dry	SS-9 21.0-22.5							
					14						
				SS-10 23.5-25.0	32						
					36						
				SS-11 26.0-27.5							
				SS-12 28.5-30.0	21						
					16						
					15						
504.5	31.0	▽	Saturated	SS-13 31.0-32.5	15						
					11						
					12						
				SS-14 33.5-35.0							
				S-15 36.0-37.5							
				SS-16 38.5-40.0	50/0.5'						
494.5	41.0		End of Boring at 41.0'								

DRILLING CONTRACTOR **Groff Testing**  
 DRILLING METHOD **4.25" I.D. HSA**  
 DRILLING EQUIPMENT **CME**  
 DRILLING STARTED **11/1/10** ENDED **11/1/10**

REMARKS  
**Installed 2" diameter PVC monitoring well.**

WATER LEVEL (ft.)  
 ▽ **31.0**  
 ▽  
 ▽

**PATRICK ENGINEERING INC.**

BORING NUMBER **B-MW-4** SHEET **1 OF 2**  
 CLIENT **Midwest Generation**  
 PROJECT & NO. **21053.070**  
 LOCATION **Joliet No. 29**

LOGGED BY **AFG**  
 GROUND ELEVATION **535.8**

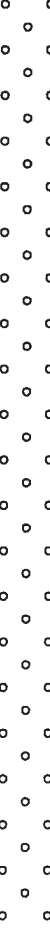
ELEVATION	DEPTH (FT)	STRATA	SOIL/ROCK DESCRIPTION	SAMPLE TYPE & NO. DEPTH (FT) RECOVERY(IN)	BLOW COUNTS	Water Content					NOTES & TEST RESULTS	
						PL	Unconfined Compressive Strength (TSF)			LL		
						10	20	30	40	50		
535.8	0.0		Coarse gravel (CA-6), dry									
534.8	1.0		Brown silty clay, trace coarse sand, stiff, dry	SS-1 1.0-2.5 6"R	6 6 7						Bentonite seal 2.0'-27.5'. Stickup protective cover installed.	
				SS-2 3.5-5.0 10"R	4 7 9							
529.8	6.0		Brown fine to coarse sand and gravel, trace limestone fragments	SS-3 6.0-7.5 6"R	20 22 12							
				SS-4 8.5-10.0 6"R	10 12 16							
			Limestone fragments, dry	SS-7 16.0-17.5 2"R	31 31							
				SS-8 18.5-20.0 4"R	24 40							

DRILLING CONTRACTOR **Groff Testing**  
 DRILLING METHOD **4.25" I.D. HSA**  
 DRILLING EQUIPMENT **CME**  
 DRILLING STARTED **11/1/10** ENDED **11/1/10**

REMARKS  
**Installed 2" diameter PVC monitoring well.**

WATER LEVEL (ft.)  
 ▽ **31.5**  
 ▽  
 ▽

<b>PATRICK ENGINEERING INC.</b>	BORING NUMBER	B-MW-4	SHEET 2 OF 2
	CLIENT	Midwest Generation	
	PROJECT & NO.	21053.070	
	LOCATION	Joliet No. 29	
LOGGED BY <b>AFG</b>			
GROUND ELEVATION <b>535.8</b>			



ELEVATION	DEPTH (FT)	STRATA	SOIL/ROCK DESCRIPTION	SAMPLE TYPE & NO. DEPTH (FT) RECOVERY(IN)	BLOW COUNTS	Water Content					NOTES & TEST RESULTS	
						PL	Unconfined Compressive Strength (TSF) *			LL		
						1	2	3	4	5		
515.8	20.0		Brown fine to coarse sand and gravel, trace limestone fragments									
					SS-9 21.0-22.5 4"R	60/6"						
				Fine to coarse sand and gravel, dry								
					SS-10 23.5-25.0 6"R	35 36						
					SS-11 26.0-27.5 10"R	28 21 10						
					SS-12 28.5-30.0 6"R	12 8 8						
					SS-13 31.0-32.5 8"R	13 17 13						
504.3	31.5		▽	Saturated								
502.8	33.0			Fine to coarse sand, saturated								
					SS-14 33.5-35.0 18"R	13 24 24						
				Fine to coarse sand and gravel, with limestone fragments								
					SS-15 36.0-37.5							
					SS-16 38.5-40.0 10"R	21 50/3"						
495.8	40.0			End of Boring at 40.0'								

DRILLING CONTRACTOR <b>Groff Testing</b> DRILLING METHOD <b>4.25" I.D. HSA</b> DRILLING EQUIPMENT <b>CME</b> DRILLING STARTED <b>11/1/10</b> ENDED <b>11/1/10</b>	REMARKS <b>Installed 2" diameter PVC monitoring well.</b>	WATER LEVEL (ft.) ▽ <b>31.5</b> ▽ ▽
--	--	--

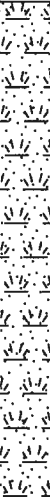

<b>PATRICK ENGINEERING INC.</b>	BORING NUMBER	<b>B-MW-5</b>	SHEET	1	OF 2
	CLIENT	<b>Midwest Generation</b>			
	PROJECT & NO.	<b>21053.070</b>			
	LOCATION	<b>Joliet No. 29</b>			

LOGGED BY **AFG**  
 GROUND ELEVATION **536.4**

ELEVATION	DEPTH (FT)	STRATA	SOIL/ROCK DESCRIPTION	SAMPLE TYPE & NO. DEPTH (FT) RECOVERY(IN)	BLOW COUNTS	Water Content					NOTES & TEST RESULTS
						PL	Unconfined Compressive Strength (TSF) *			LL	
						10	20	30	40	50	
						1	2	3	4	5	
536.4	0.0		Fine to coarse gravel, topsoil, dry	SS-1 1.0-2.5							Bentonite seal 2.0'-32.0'. Stickup protective cover installed.
			SS-2 3.5-5.0								
			SS-3 6.0-7.5								
527.9	8.5		Black silty clay, coarse sand, moist to wet	SS-4 8.5-10.0 1"R	2 4 2						
			SS-5 13.5-15.0 8"R		2 4 3						
			SS-6 16.0-17.5								
			Coarse gravel fragments	SS-7 18.5-20.0 0.5"R	4 3 3						
			SS-8 21.0-22.5								

DRILLING CONTRACTOR	<b>Groff Testing</b>
DRILLING METHOD	<b>4.25" I.D. HSA</b>
DRILLING EQUIPMENT	<b>CME</b>
DRILLING STARTED	<b>11/2/10 ENDED 11/2/10</b>

REMARKS	<b>Installed 2" diameter PVC monitoring well.</b>
---------	---

WATER LEVEL (ft.)	<b>▽ 31.0</b>
	<b>▽</b>
	<b>▽</b>

**PATRICK ENGINEERING INC.**

BORING NUMBER **B-MW-5** SHEET **2 OF 2**  
 CLIENT **Midwest Generation**  
 PROJECT & NO. **21053.070**  
 LOCATION **Joliet No. 29**

LOGGED BY **AFG**  
 GROUND ELEVATION **536.4**

ELEVATION	DEPTH (FT)	STRATA	SOIL/ROCK DESCRIPTION	SAMPLE TYPE & NO. DEPTH (FT) RECOVERY(IN)	BLOW COUNTS	Water Content					NOTES & TEST RESULTS
						PL	Unconfined Compressive Strength (TSF) *			LL	
						1	2	3	4	5	
513.9	23.5		Tan to light brown fine to coarse sand, little coarse gravel, dry	SS-9 23.5-25.0 12"R	27 35 38						
505.4	31.0		Fine to coarse sand and gravel, saturated	SS-10 26.0-27.5	42 49						
				SS-11 28.5-30.0 8"R	7 8 9						
				SS-12 31.0-32.5 4"R	7 10 27						Sand pack 30.0'-42.0'
				SS-13 33.5-35.0							Set screen (slot 0.010") 32.0'-42.0'
				SS-14 36.0-37.5							
				SS-15 38.5-40.0	29 18						
494.4	42.0		Tan to light brown fine to coarse sand, little coarse gravel, dry								
			End of Boring at 42.0'								

DRILLING CONTRACTOR **Groff Testing**  
 DRILLING METHOD **4.25" I.D. HSA**  
 DRILLING EQUIPMENT **CME**  
 DRILLING STARTED **11/2/10** ENDED **11/2/10**

REMARKS  
**Installed 2" diameter PVC monitoring well.**

WATER LEVEL (ft.)  
**31.0**

<b>PATRICK ENGINEERING INC.</b>	BORING NUMBER <b>B-MW-6</b>	SHEET <b>1 OF 2</b>
	CLIENT <b>Midwest Generation</b>	
	PROJECT & NO. <b>21053.070</b>	
	LOCATION <b>Joliet No. 29</b>	
LOGGED BY <b>AFG</b>		
GROUND ELEVATION <b>535.9</b>		

ELEVATION	DEPTH (FT)	STRATA	SOIL/ROCK DESCRIPTION	SAMPLE TYPE & NO. DEPTH (FT) RECOVERY(IN)	BLOW COUNTS	Water Content					NOTES & TEST RESULTS
						PL	Unconfined Compressive Strength (TSF) *			LL	
						1	2	3	4	5	
535.9	0.0		Gravel (CA-6), topsoil, dry	SS-1 1.0-2.5							Bentonite seal 2.0'-30.5'. Stickup protective cover installed.
				SS-2 3.5-5.0							
				SS-3 6.0-7.5							
527.4	8.5		Brown to tan fine to coarse sand and gravel, trace limestone, gravel seams, dry	SS-4 8.5-10.0 12"R	12 12 12						
				SS-5 11.0-12.5							
				SS-6 13.5-15.0 14"R	23 30 27						
				SS-7 16.0-17.5							
				SS-8 18.5-20.0 12"R	18 28 24						

DRILLING CONTRACTOR <b>Groff Testing</b> DRILLING METHOD <b>4.25" I.D. HSA</b> DRILLING EQUIPMENT <b>CME</b> DRILLING STARTED <b>11/3/10</b> ENDED <b>11/3/10</b>	REMARKS <b>Installed 2" diameter PVC monitoring well.</b>	WATER LEVEL (ft.) ▽ <b>31.0</b> ▽ ▽
--	--	--

**PATRICK ENGINEERING INC.**

BORING NUMBER **B-MW-6** SHEET **2 OF 2**  
 CLIENT **Midwest Generation**  
 PROJECT & NO. **21053.070**  
 LOCATION **Joliet No. 29**

LOGGED BY **AFG**  
 GROUND ELEVATION **535.9**

ELEVATION	DEPTH (FT)	STRATA	SOIL/ROCK DESCRIPTION	SAMPLE TYPE & NO. DEPTH (FT) RECOVERY(IN)	BLOW COUNTS	Water Content					NOTES & TEST RESULTS	
						PL	Unconfined Compressive Strength (TSF) *			LL		
						10	20	30	40	50		
						1	2	3	4	5		
514.9	21.0		Brown to tan fine to coarse sand and gravel, trace limestone, gravel seams, dry	SS-9 21.0-22.5	23 34 18/3"						Sand pack 28.0'-40.5'  Set screen (slot 0.010) 30.5'-40.5'	
				SS-10 23.5-25.0 14"R								
				SS-11 26.0-27.5								
				SS-12 28.5-30.0 12"R	33 21 27							
				SS-13 31.0-32.5 12"R								
				SS-14 33.5-35.0								
504.9	31.0			Fine to coarse sand and gravel, saturated	SS-15 36.0-37.5							
497.4	38.5			Limestone bedrock	SS-16 38.5-40.0 0.5"R	50/0.5'						
495.4	40.5			End of Boring at 40.5'								

DRILLING CONTRACTOR **Groff Testing**  
 DRILLING METHOD **4.25" I.D. HSA**  
 DRILLING EQUIPMENT **CME**  
 DRILLING STARTED **11/3/10** ENDED **11/3/10**

REMARKS  
**Installed 2" diameter PVC monitoring well.**

WATER LEVEL (ft.)  
 ∇ 31.0  
 ∇  
 ∇

**PATRICK ENGINEERING INC.**

BORING NUMBER **B-MW-7** SHEET **1 OF 2**  
 CLIENT **Midwest Generation**  
 PROJECT & NO. **21053.070**  
 LOCATION **Joliet No. 29**

LOGGED BY **AFG**  
 GROUND ELEVATION **535.9**

ELEVATION	DEPTH (FT)	STRATA	SOIL/ROCK DESCRIPTION	SAMPLE TYPE & NO. DEPTH (FT) RECOVERY(IN)	BLOW COUNTS	Water Content					NOTES & TEST RESULTS
						PL	Unconfined Strength (TSF)	Compressive	LL		
						1	2	3	4	5	
535.9	0.0		Gravel (CA-6), topsoil, dry	SS-1 1.0-2.5							Bentonite seal 2.0'-28.75'. Stickup protective cover installed.
				SS-2 3.5-5.0							
				SS-3 6.0-7.5							
527.4	8.5		Tan to brown fine to coarse sand and gravel, dry	SS-4 8.5-10.0 8"R	32 16 17						
				SS-5 11.0-12.5							
				SS-6 13.5-15.0	13 21						
				SS-7 16.0-17.5							
				SS-8 18.5-20.0	28 17						

DRILLING CONTRACTOR **Groff Testing**  
 DRILLING METHOD **4.25" I.D. HSA**  
 DRILLING EQUIPMENT **CME**  
 DRILLING STARTED **11/3/10** ENDED **11/3/10**

REMARKS  
**Installed 2" diameter PVC monitoring well.**

WATER LEVEL (ft.)  
 ▽ **31.0**  
 ▽  
 ▽





<b>PATRICK ENGINEERING INC.</b>	BORING NUMBER	<b>B-MW-8</b>	SHEET	1 OF 2
	CLIENT	<b>Midwest Generation</b>		
	PROJECT & NO.	<b>21053.070</b>		
	LOCATION	<b>Joliet No. 29</b>		

LOGGED BY **AFG**  
 GROUND ELEVATION **533.7**

ELEVATION	DEPTH (FT)	STRATA	SOIL/ROCK DESCRIPTION	SAMPLE TYPE & NO. DEPTH (FT) RECOVERY(IN)	BLOW COUNTS	Water Content					NOTES & TEST RESULTS	
						PL	Unconfined Compressive Strength (TSF) *			LL		
						10	20	30	40	50		
						1	2	3	4	5		
533.7	0.0		Fine to coarse gravel fill, dry									
532.7	1.0		Dark brown silty clay, some fine to coarse sand, stiff, moist	SS-1 1.0-2.5 6"R	2 5 9							
530.2	3.5		Black/brown fine to coarse sand and gravel, moist	SS-2 3.5-5.0 6"R	5 5 10							
			Limestone fragments, dry	SS-3 6.0-7.5 8"R	13 16 14							
				SS-4 8.5-10.0 8"R	7 15 22							
				SS-5 11.0-12.5 8"R	15 13 13							
				SS-6 13.5-15.0 8"R	17 14 12							
				SS-7 16.0-17.5 8"R	5 12 8							
				SS-8 18.5-20.0 3"R	12 9 9							

DRILLING CONTRACTOR **Groff Testing**  
 DRILLING METHOD **4.25" I.D. HSA**  
 DRILLING EQUIPMENT **CME**  
 DRILLING STARTED **10/27/10** ENDED **10/27/10**

REMARKS  
**Installed 2" diameter PVC monitoring well.**

WATER LEVEL (ft.)  
 ▽ **27.0**  
 ▽  
 ▽

Bentonite seal  
 2.0'-25.5'. Stickup  
 protective cover  
 installed.

<b>PATRICK ENGINEERING INC.</b>	BORING NUMBER <b>B-MW-8</b>	SHEET <b>2 OF 2</b>
	CLIENT <b>Midwest Generation</b>	
	PROJECT & NO. <b>21053.070</b>	
	LOCATION <b>Joliet No. 29</b>	

LOGGED BY **AFG**  
 GROUND ELEVATION **533.7**

ELEVATION	DEPTH (FT)	STRATA	SOIL/ROCK DESCRIPTION	SAMPLE TYPE & NO. DEPTH (FT) RECOVERY(IN)	BLOW COUNTS	Water Content					NOTES & TEST RESULTS
						PL	Unconfined Compressive Strength (TSF) *			LL	
						1	2	3	4	5	
513.7	20.0		Black/brown fine to coarse sand and gravel, moist	SS-9 21.0-22.5 4"R	5 4 5						Sand pack 23.0'-35.5'  Screen set (slot 0.010) 25.5'-35.5'
			Moist to wet	SS-10 23.5-25.0 6"R	6 9 18						
506.7	27.0		▽ Saturated	SS-11 26.0-27.5 8"R	6 9 8						
				SS-12 28.5-30.0 6"R	4 8 8						
				SS-13 33.5-35.0 2"R	50/1"						
498.2	35.5			End of Boring at 35.5'							

DRILLING CONTRACTOR <b>Groff Testing</b> DRILLING METHOD <b>4.25" I.D. HSA</b> DRILLING EQUIPMENT <b>CME</b> DRILLING STARTED <b>10/27/10</b> ENDED <b>10/27/10</b>	REMARKS <b>Installed 2" diameter PVC monitoring well.</b>	WATER LEVEL (ft.) ▽ <b>27.0</b> ▽ ▽
--	--	--

**PATRICK ENGINEERING INC.**

BORING NUMBER **B-MW-9** SHEET **1 OF 2**  
 CLIENT **Midwest Generation**  
 PROJECT & NO. **21053.070**  
 LOCATION **Joliet No. 29**

LOGGED BY **AFG**  
 GROUND ELEVATION **531.1**

ELEVATION	DEPTH (FT)	STRATA	SOIL/ROCK DESCRIPTION	SAMPLE TYPE & NO. DEPTH (FT) RECOVERY(IN)	BLOW COUNTS	Water Content					NOTES & TEST RESULTS
						PL	Unconfined Compressive Strength (TSF) *			LL	
						10	20	30	40	50	
531.1	0.0		Coarse sand and gravel (CA-6), dry								
530.1	1.0		Coarse gravel, with black silty clay, trace root seams, moist	SS-1 1.0-2.5 6"R	15 14 13						Bentonite seal 2.0'-34.75'. Stickup protective cover installed.
527.6	3.5		Coarse gravel fragments, with fine to coarse sand, dry	SS-2 3.5-5.0 2"R	4 5 6						
				SS-3 6.0-7.5							
				SS-4 8.5-10.0							
520.1	11.0		Limestone fragments, with light brown silty fine to coarse sand, dry	SS-5 11.0-12.5 8"R	34 37						
				SS-6 13.5-15.0 10"R	20 16 16						
				SS-7 16.0-17.5 6"R	10 15 23						
512.6	18.5		Limestone fragments, with light brown to dark orange fine to coarse sand, moist	SS-8 18.5-20.0 10"R	15 24 28						

DRILLING CONTRACTOR **Groff Testing**  
 DRILLING METHOD **4.25" I.D. HSA**  
 DRILLING EQUIPMENT **CME**  
 DRILLING STARTED **10/29/10** ENDED **10/29/10**

REMARKS  
**Installed 2" diameter PVC monitoring well.**

WATER LEVEL (ft.)  
 ▽ **26.0**  
 ▽  
 ▽



**PATRICK ENGINEERING INC.**

BORING NUMBER **B-MW-10** SHEET **1** OF **2**  
 CLIENT **Midwest Generation**  
 PROJECT & NO. **21053.070**  
 LOCATION **Joliet No. 29**

LOGGED BY **AFG**  
 GROUND ELEVATION **536.9**

ELEVATION	DEPTH (FT)	STRATA	SOIL/ROCK DESCRIPTION	SAMPLE TYPE & NO. DEPTH (FT) RECOVERY(IN)	BLOW COUNTS	Water Content					NOTES & TEST RESULTS		
						PL	Unconfined Compressive Strength (TSF) *			LL			
						10	20	30	40	50			
536.9	0.0		Coarse gravel, dry										
			SS-1 1.0-2.5 10"R	5 4 5								Bentonite seal 2.0'-28.0'. Stickup protective cover installed.	
			Brown clay										
			SS-2 3.5-5.0 10"R	3 2 2									
			SS-3 6.0-7.5 16"R	2 1 1									
529.9	7.0			Black/gray sandy silt, moist									
				SS-4 8.5-10.0 12"R	1 3 1								
				SS-5 11.0-12.5 18"R	1 1 1								
				SS-6 13.5-15.0 18"R	1 2 2								
				SS-7 16.0-17.5 18"R	1 3 2								
		SS-8 18.5-20.0 18"R		2 3 4									
517.9	19.0			Gray silty clay, trace coarse sand, soft, wet									

DRILLING CONTRACTOR **Groff Testing**  
 DRILLING METHOD **4.25" I.D. HSA**  
 DRILLING EQUIPMENT **CME**  
 DRILLING STARTED **11/2/10** ENDED **11/2/10**

REMARKS  
**Installed 2" diameter PVC monitoring well.**

WATER LEVEL (ft.)  
 ▽ **31.0**  
 ▽  
 ▽

<b>PATRICK ENGINEERING INC.</b>	BORING NUMBER	<b>B-MW-10</b>	SHEET	<b>2</b>	OF	<b>2</b>
	CLIENT	<b>Midwest Generation</b>				
	PROJECT & NO.	<b>21053.070</b>				
	LOCATION	<b>Joliet No. 29</b>				
LOGGED BY <b>AFG</b>						
GROUND ELEVATION <b>536.9</b>						

ELEVATION	DEPTH (FT)	STRATA	SOIL/ROCK DESCRIPTION	SAMPLE TYPE & NO. DEPTH (FT) RECOVERY(IN)	BLOW COUNTS	Water Content					NOTES & TEST RESULTS		
						PL	Unconfined Compressive Strength (TSF)			LL			
						10	20	30	40	50			
						1	2	3	4	5			
515.9	21.0		Gray silty clay, trace coarse sand, soft, wet	SS-9 21.0-22.5 8"R	12 28 31						Sand pack 28.0'-40.5'  Screen set (slot 0.010) 30.5'-40.5'		
				SS-10 23.5-25.0 10"R	11 24 21								
				SS-11 26.0-27.5 12"R	6 13 17								
				SS-12 28.5-30.0 18"R	13 19 24								
				SS-13 31.0-32.5 10"R	28 24 14								
				SS-14 33.5-35.0 18"R	16 63 12								
				SS-15 36.0-37.5									
				SS-16 38.5-40.0 18"R	9 14								
505.9	31.0			▽									
495.9	41.0				End of Boring at 41.0'								

DRILLING CONTRACTOR <b>Groff Testing</b> DRILLING METHOD <b>4.25" I.D. HSA</b> DRILLING EQUIPMENT <b>CME</b> DRILLING STARTED <b>11/2/10</b> ENDED <b>11/2/10</b>	REMARKS <b>Installed 2" diameter PVC monitoring well.</b>	WATER LEVEL (ft.) ▽ 31.0 ▽ ▽
--	--	---------------------------------------



**PATRICK ENGINEERING INC.**

BORING NUMBER **B-MW-11** SHEET **1 OF 2**  
 CLIENT **Midwest Generation**  
 PROJECT & NO. **21053.070**  
 LOCATION **Joliet No. 29**

LOGGED BY **AFG**  
 GROUND ELEVATION **536.5**

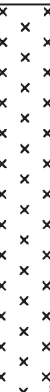
ELEVATION	DEPTH (FT)	STRATA	SOIL/ROCK DESCRIPTION	SAMPLE TYPE & NO. DEPTH (FT) RECOVERY(IN)	BLOW COUNTS	Water Content					NOTES & TEST RESULTS
						PL	Unconfined Compressive Strength (TSF)		LL		
						1	2	3	4	5	
536.5	0.0		Fine to coarse sand and gravel, fill, dry								Bentonite seal 2.0'-27.0'. Stickup protective cover installed.
			SS-1 1.0-2.5								
			SS-2 3.5-5.0		3 2 2						
			SS-3 6.0-7.5								
			SS-4 8.5-10.0	Grades to dark gray clayey silt	3 2 2						
			SS-5 11.0-12.5								
			SS-6 13.5-15.0	Dark gray clayey silt, soft, moist	1 2 2						
			SS-7 16.0-17.5								
			SS-8 18.5-20.0		1 3 5						
522.5	14.0										

DRILLING CONTRACTOR **Groff Testing**  
 DRILLING METHOD **4.25" I.D. HSA**  
 DRILLING EQUIPMENT **CME**  
 DRILLING STARTED **11/4/10** ENDED **11/4/10**

REMARKS  
**Installed 2" diameter PVC monitoring well.**

WATER LEVEL (ft.)  
 ▽ 31.0  
 ▽  
 ▽



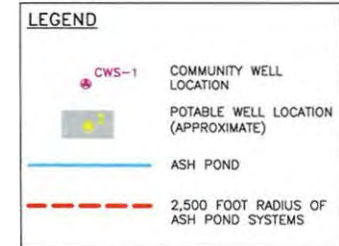
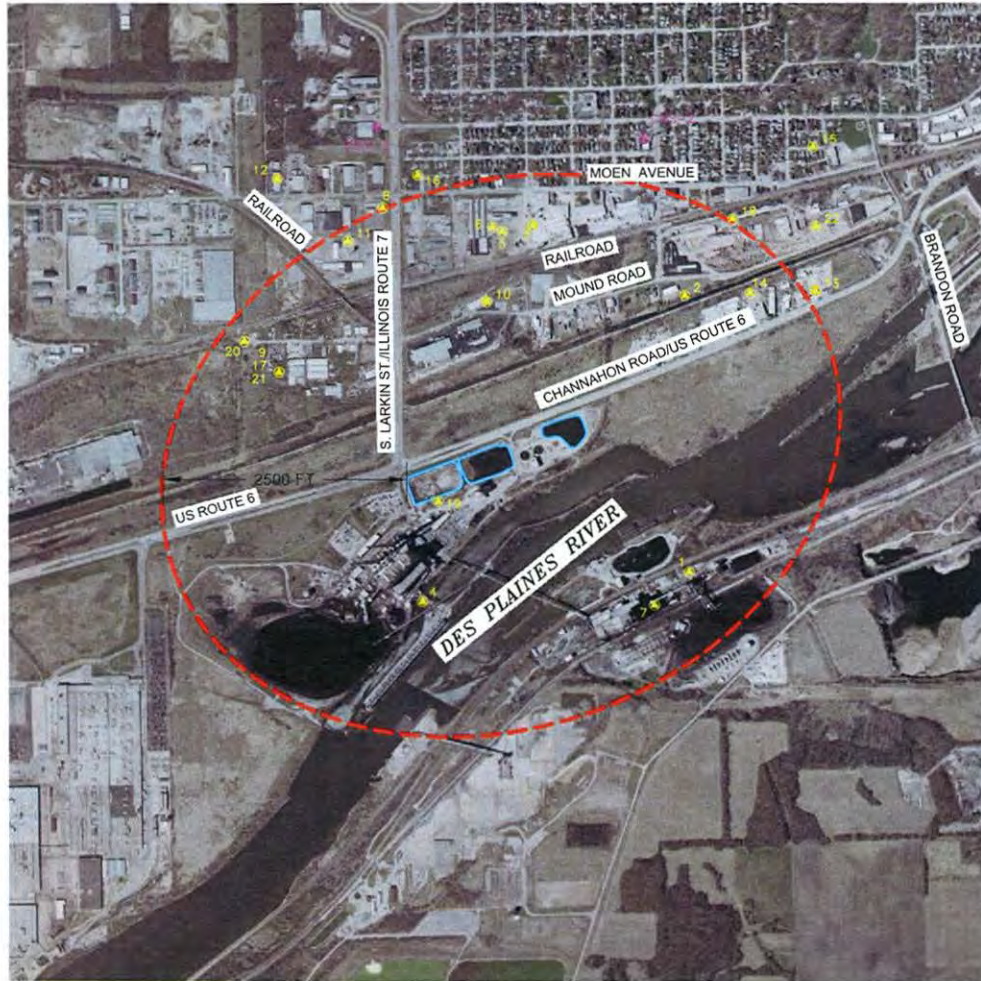

NOTE:  
REFER TO SUMMARY TABLE FOR SPECIFIC WELL INFORMATION.

SOURCE:  
2005 DIGITAL ORTHOPHOTO FROM ILLINOIS NATURAL RESOURCES GEOSPATIAL DATA CLEARINGHOUSE  
WELL LOCATIONS FROM ILLINOIS STATE GEOLOGICAL SURVEY, ILLINOIS ENVIRONMENTAL PROTECTION AGENCY, AND ILLINOIS STATE WATER SURVEY.

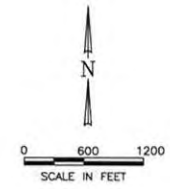

DRAWN BY: RLH/KNW	DATE: 05/20/09
CHECKED BY: HMS	DATE: 05/22/09
APPROVED BY: HMS	DATE: 07/07/09
DRAWING NO: 1792-3_B03_050945.sld	
REFERENCE: 065930.sld, 065945.sld	

**POTABLE WATER WELLS**

JOLIET STATION NO. 29  
MIDWEST GENERATION  
ROCKDALE, WILL COUNTY, ILLINOIS



PROJECT NO. 1792/3.0
FIGURE NO. 1



## ANALYTICAL REPORT

Job Number: 500-29703-1

Job Description: Joliet Ash Pond Assessments

For:

Midwest Generation EME LLC  
1800 Channahon Road  
Joliet, IL 60436

Attention: James DiCola

Approved for release.  
Cindy R Pritchard  
Project Mgmt. Assistant  
12/17/2010 1:46 PM

---

Designee for  
Bonnie M Stadelmann  
Project Manager II  
bonnie.stadelmann@testamericainc.com  
12/17/2010

cc: Andrew Gagnon  
Ms. Maria Race

These test results meet all the requirements of NELAC for accredited parameters.

The Lab Certification ID#:  
TestAmerica Chicago 100201

All questions regarding this test report should be directed to the TestAmerica Project Manager whose signature appears on this report. All pages of this report are integral parts of the analytical data. Therefore, this report should be reproduced only in its entirety.

**TestAmerica Laboratories, Inc.**  
TestAmerica Chicago 2417 Bond Street, University Park, IL 60484  
Tel (708) 534-5200 Fax (708) 534-5211 [www.testamericainc.com](http://www.testamericainc.com)



**Job Narrative**  
**500-29703-1**

**Comments**

No additional comments.

**Receipt**

All samples were received in good condition within temperature requirements.

**Metals**

The matrix spike / matrix spike duplicate (MS/MSD) recoveries for sample 500-29703-1 were outside control limits for Ag. The MSD was also out for Se. The associated laboratory control sample (LCS) recovery met acceptance criteria.

No other analytical or quality issues were noted.

**Field Service / Mobile Lab**

No analytical or quality issues were noted.

**General Chemistry**

Method(s) 353.2, SM 4500 NO3 F: The nitrate continuing calibration verification (CCV) for 101888 recovered above the upper control limit. The samples associated with this CCV were non-detects for the affected analytes; therefore, the data have been reported. MW-06 (500-29703-6), MW-07 (500-29703-7), MW-09 (500-29703-9)

No other analytical or quality issues were noted.

## EXECUTIVE SUMMARY - Detections

Client: Midwest Generation EME LLC

Job Number: 500-29703-1

Lab Sample ID Analyte	Client Sample ID	Result / Qualifier	Reporting Limit	Units	Method
<b>500-29703-1</b>	<b>MW-01</b>				
<i>Dissolved</i>					
Antimony		0.0043	0.0030	mg/L	6020
Arsenic		0.0011	0.0010	mg/L	6020
Barium		0.13	0.0025	mg/L	6020
Boron		0.31	0.050	mg/L	6020
Copper		0.0032	0.0020	mg/L	6020
Nickel		0.0034	0.0020	mg/L	6020
Sulfate-Dissolved		180	50	mg/L	9038
Chloride-Dissolved		140	10	mg/L	9251
Nitrogen, Nitrate-Dissolved		1.9	0.10	mg/L	Nitrate by calc
Total Dissolved Solids-Dissolved		590	10	mg/L	SM 2540C
Fluoride-Dissolved		0.45	0.10	mg/L	SM 4500 F C
Nitrogen, Nitrate Nitrite-Dissolved		1.9	0.20	mg/L	SM 4500 NO3 F
<b>500-29703-2</b>	<b>MW-02</b>				
<i>Dissolved</i>					
Antimony		0.012	0.0030	mg/L	6020
Barium		0.082	0.0025	mg/L	6020
Boron		0.31	0.050	mg/L	6020
Copper		0.0032	0.0020	mg/L	6020
Nickel		0.0033	0.0020	mg/L	6020
Sulfate-Dissolved		190	50	mg/L	9038
Chloride-Dissolved		140	10	mg/L	9251
Nitrogen, Nitrate-Dissolved		3.1	0.10	mg/L	Nitrate by calc
Total Dissolved Solids-Dissolved		600	10	mg/L	SM 2540C
Fluoride-Dissolved		0.62	0.10	mg/L	SM 4500 F C
Nitrogen, Nitrate Nitrite-Dissolved		3.1	0.20	mg/L	SM 4500 NO3 F
<b>500-29703-3</b>	<b>MW-03</b>				
<i>Dissolved</i>					
Antimony		0.0040	0.0030	mg/L	6020
Barium		0.089	0.0025	mg/L	6020
Boron		0.24	0.050	mg/L	6020
Cobalt		0.0013	0.0010	mg/L	6020
Manganese		0.10	0.0025	mg/L	6020
Nickel		0.011	0.0020	mg/L	6020
Sulfate-Dissolved		120	50	mg/L	9038
Chloride-Dissolved		260	10	mg/L	9251
Total Dissolved Solids-Dissolved		930	10	mg/L	SM 2540C
Fluoride-Dissolved		0.43	0.10	mg/L	SM 4500 F C



**EXECUTIVE SUMMARY - Detections**

Client: Midwest Generation EME LLC

Job Number: 500-29703-1

Lab Sample ID Analyte	Client Sample ID	Result / Qualifier	Reporting Limit	Units	Method
<b>500-29703-4</b>	<b>MW-04</b>				
<i>Dissolved</i>					
Barium		0.065	0.0025	mg/L	6020
Boron		0.46	0.050	mg/L	6020
Manganese		0.33	0.0025	mg/L	6020
Nickel		0.0067	0.0020	mg/L	6020
Selenium		0.0025	0.0025	mg/L	6020
Sulfate-Dissolved		300	50	mg/L	9038
Chloride-Dissolved		270	10	mg/L	9251
Nitrogen, Nitrate-Dissolved		0.81	0.10	mg/L	Nitrate by calc
Total Dissolved Solids-Dissolved		1100	10	mg/L	SM 2540C
Fluoride-Dissolved		0.49	0.10	mg/L	SM 4500 F C
Nitrogen, Nitrate Nitrite-Dissolved		0.81	0.10	mg/L	SM 4500 NO3 F
<b>500-29703-5</b>	<b>MW-05</b>				
<i>Dissolved</i>					
Barium		0.061	0.0025	mg/L	6020
Boron		0.42	0.050	mg/L	6020
Manganese		0.0065	0.0025	mg/L	6020
Sulfate-Dissolved		110	25	mg/L	9038
Chloride-Dissolved		150	10	mg/L	9251
Total Dissolved Solids-Dissolved		750	10	mg/L	SM 2540C
Fluoride-Dissolved		0.40	0.10	mg/L	SM 4500 F C
<b>500-29703-6</b>	<b>MW-06</b>				
<i>Dissolved</i>					
Barium		0.075	0.0025	mg/L	6020
Boron		0.32	0.050	mg/L	6020
Manganese		0.14	0.0025	mg/L	6020
Nickel		0.0056	0.0020	mg/L	6020
Selenium		0.0029	0.0025	mg/L	6020
Sulfate-Dissolved		140	50	mg/L	9038
Chloride-Dissolved		130	10	mg/L	9251
Total Dissolved Solids-Dissolved		650	10	mg/L	SM 2540C
Fluoride-Dissolved		0.40	0.10	mg/L	SM 4500 F C

## EXECUTIVE SUMMARY - Detections

Client: Midwest Generation EME LLC

Job Number: 500-29703-1

Lab Sample ID Analyte	Client Sample ID	Result / Qualifier	Reporting Limit	Units	Method
<b>500-29703-7</b>	<b>MW-07</b>				
<i>Dissolved</i>					
Arsenic		0.0010	0.0010	mg/L	6020
Barium		0.13	0.0025	mg/L	6020
Boron		0.51	0.050	mg/L	6020
Manganese		0.29	0.0025	mg/L	6020
Nickel		0.0045	0.0020	mg/L	6020
Sulfate-Dissolved		250	50	mg/L	9038
Chloride-Dissolved		430	50	mg/L	9251
Total Dissolved Solids-Dissolved		1200	10	mg/L	SM 2540C
Fluoride-Dissolved		0.36	0.10	mg/L	SM 4500 F C
<b>500-29703-8</b>	<b>MW-08</b>				
<i>Dissolved</i>					
Barium		0.054	0.0025	mg/L	6020
Boron		0.29	0.050	mg/L	6020
Manganese		0.0051	0.0025	mg/L	6020
Nickel		0.0025	0.0020	mg/L	6020
Sulfate-Dissolved		210	50	mg/L	9038
Chloride-Dissolved		130	10	mg/L	9251
Nitrogen, Nitrate-Dissolved		0.33	0.10	mg/L	Nitrate by calc
Total Dissolved Solids-Dissolved		670	10	mg/L	SM 2540C
Fluoride-Dissolved		0.51	0.10	mg/L	SM 4500 F C
Nitrogen, Nitrate Nitrite-Dissolved		0.33	0.10	mg/L	SM 4500 NO3 F
<b>500-29703-9</b>	<b>MW-09</b>				
<i>Dissolved</i>					
Barium		0.031	0.0025	mg/L	6020
Boron		0.36	0.050	mg/L	6020
Cobalt		0.0047	0.0010	mg/L	6020
Manganese		1.1	0.0025	mg/L	6020
Nickel		0.0094	0.0020	mg/L	6020
Sulfate-Dissolved		1600	250	mg/L	9038
Chloride-Dissolved		140	10	mg/L	9251
Total Dissolved Solids-Dissolved		2600	10	mg/L	SM 2540C
Fluoride-Dissolved		0.61	0.10	mg/L	SM 4500 F C

**EXECUTIVE SUMMARY - Detections**

Client: Midwest Generation EME LLC

Job Number: 500-29703-1

Lab Sample ID Analyte	Client Sample ID	Result / Qualifier	Reporting Limit	Units	Method
<b>500-29703-10</b>	<b>MW-10</b>				
<i>Dissolved</i>					
Barium		0.050	0.0025	mg/L	6020
Boron		0.50	0.050	mg/L	6020
Manganese		0.12	0.0025	mg/L	6020
Nickel		0.0052	0.0020	mg/L	6020
Sulfate-Dissolved		130	50	mg/L	9038
Chloride-Dissolved		200	10	mg/L	9251
Nitrogen, Nitrate-Dissolved		0.39	0.10	mg/L	Nitrate by calc
Total Dissolved Solids-Dissolved		860	10	mg/L	SM 2540C
Fluoride-Dissolved		0.43	0.10	mg/L	SM 4500 F C
Nitrogen, Nitrate Nitrite-Dissolved		0.39	0.10	mg/L	SM 4500 NO3 F
<b>500-29703-11</b>	<b>MW-11</b>				
<i>Dissolved</i>					
Arsenic		0.0013	0.0010	mg/L	6020
Barium		0.064	0.0025	mg/L	6020
Boron		0.47	0.050	mg/L	6020
Manganese		0.052	0.0025	mg/L	6020
Nickel		0.0022	0.0020	mg/L	6020
Sulfate-Dissolved		140	50	mg/L	9038
Chloride-Dissolved		160	10	mg/L	9251
Nitrogen, Nitrate-Dissolved		0.39	0.10	mg/L	Nitrate by calc
Total Dissolved Solids-Dissolved		770	10	mg/L	SM 2540C
Fluoride-Dissolved		0.34	0.10	mg/L	SM 4500 F C
Nitrogen, Nitrate Nitrite-Dissolved		0.39	0.10	mg/L	SM 4500 NO3 F

Electronic Filing: Received, Clerk's Office 3/24/2022  
**METHOD SUMMARY**

Client: Midwest Generation EME LLC

Job Number: 500-29703-1

Description	Lab Location	Method	Preparation Method
<b>Matrix: Water</b>			
Metals (ICP/MS)	TAL CHI	SW846 6020	
Preparation, Soluble	TAL CHI		Soluble Metals
Sample Filtration, Field			FIELD_FLTRD
Mercury (CVAA)	TAL CHI	SW846 7470A	
Preparation, Mercury	TAL CHI		SW846 7470A
Sample Filtration, Field			FIELD_FLTRD
Cyanide	TAL CHI	SW846 9014	
Cyanide, Distillation	TAL CHI		SW846 9010B
Sample Filtration, Field			FIELD_FLTRD
Sulfate, Turbidimetric	TAL CHI	SW846 9038	
Sample Filtration, Field			FIELD_FLTRD
Chloride	TAL CHI	SW846 9251	
Sample Filtration, Field			FIELD_FLTRD
Nitrogen, Nitrate-Nitrite	TAL CHI	SM Nitrate by calc	
Sample Filtration, Field			FIELD_FLTRD
Solids, Total Dissolved (TDS)	TAL CHI	SM SM 2540C	
Sample Filtration, Field			FIELD_FLTRD
Fluoride	TAL CHI	SM SM 4500 F C	
Sample Filtration, Field			FIELD_FLTRD
Nitrogen, Nitrite	TAL CHI	SM SM 4500 NO2 B	
Sample Filtration, Field			FIELD_FLTRD
Nitrogen, Nitrate	TAL CHI	SM SM 4500 NO3 F	
Sample Filtration, Field			FIELD_FLTRD

**Lab References:**

TAL CHI = TestAmerica Chicago

**Method References:**

SM = "Standard Methods For The Examination Of Water And Wastewater",

SW846 = "Test Methods For Evaluating Solid Waste, Physical/Chemical Methods", Third Edition, November 1986 And Its Updates.

**METHOD / ANALYST SUMMARY**

Client: Midwest Generation EME LLC

Job Number: 500-29703-1

<b>Method</b>	<b>Analyst</b>	<b>Analyst ID</b>
SW846 6020	Kolarczyk, Paul F	PFK
SW846 7470A	Roach, Jessica	JR
SW846 9014	Moore, Colleen L	CLM
SW846 9038	Boyd, Cheryl L	CLB
SW846 9251	Deb, Khona	KD
SM Nitrate by calc	Ficarello, Peter M	PMF
SM SM 2540C	Boyd, Cheryl L	CLB
SM SM 4500 F C	Moore, Colleen L	CLM
SM SM 4500 NO2 B	Moore, Colleen L	CLM
SM SM 4500 NO3 F	Ficarello, Peter M	PMF

Electronic Filing: Received, Clerk's Office 3/24/2022  
**SAMPLE SUMMARY**

Client: Midwest Generation EME LLC

Job Number: 500-29703-1

<b>Lab Sample ID</b>	<b>Client Sample ID</b>	<b>Client Matrix</b>	<b>Date/Time Sampled</b>	<b>Date/Time Received</b>
500-29703-1	MW-01	Water	12/06/2010 1425	12/07/2010 1250
500-29703-2	MW-02	Water	12/06/2010 1345	12/07/2010 1250
500-29703-3	MW-03	Water	12/07/2010 1010	12/07/2010 1250
500-29703-4	MW-04	Water	12/07/2010 1100	12/07/2010 1250
500-29703-5	MW-05	Water	12/07/2010 1145	12/07/2010 1250
500-29703-6	MW-06	Water	12/07/2010 0930	12/07/2010 1250
500-29703-7	MW-07	Water	12/07/2010 0855	12/07/2010 1250
500-29703-8	MW-08	Water	12/06/2010 1455	12/07/2010 1250
500-29703-9	MW-09	Water	12/06/2010 1115	12/07/2010 1250
500-29703-10	MW-10	Water	12/06/2010 1520	12/07/2010 1250
500-29703-11	MW-11	Water	12/06/2010 1600	12/07/2010 1250



# **SAMPLE RESULTS**

James DiCola  
 Midwest Generation EME LLC  
 1800 Channahon Road  
 Joliet, IL 60436

Job Number: 500-29703-1

**Client Sample ID: MW-01**  
**Lab Sample ID: 500-29703-1**

Date Sampled: 12/06/2010 1425  
 Date Received: 12/07/2010 1250  
 Client Matrix: Water

Analyte	Result/Qualifier	Unit	RL	Dilution
<b>Method: Dissolved-6020</b>		Date Analyzed:	12/13/2010 2048	
<b>Prep Method: Soluble Metals</b>		Date Prepared:	12/08/2010 1252	
Beryllium	<0.0010	mg/L	0.0010	1.0
Boron	0.31	mg/L	0.050	1.0
<b>Method: Dissolved-6020</b>		Date Analyzed:	12/14/2010 1936	
<b>Prep Method: Soluble Metals</b>		Date Prepared:	12/08/2010 1252	
Arsenic	0.0011	mg/L	0.0010	1.0
Barium	0.13	mg/L	0.0025	1.0
Cadmium	<0.00050	mg/L	0.00050	1.0
Chromium	<0.0050	mg/L	0.0050	1.0
Cobalt	<0.0010	mg/L	0.0010	1.0
Copper	0.0032	mg/L	0.0020	1.0
Iron	<0.10	mg/L	0.10	1.0
Lead	<0.00050	mg/L	0.00050	1.0
Manganese	<0.0025	mg/L	0.0025	1.0
Nickel	0.0034	mg/L	0.0020	1.0
Selenium	<0.0025	mg/L	0.0025	1.0
Silver	<0.00050	mg/L	0.00050	1.0
Thallium	<0.0020	mg/L	0.0020	1.0
Zinc	<0.020	mg/L	0.020	1.0
<b>Method: Dissolved-6020</b>		Date Analyzed:	12/17/2010 1023	
<b>Prep Method: Soluble Metals</b>		Date Prepared:	12/08/2010 1252	
Antimony	0.0043	mg/L	0.0030	1.0
<b>Method: Dissolved-7470A</b>		Date Analyzed:	12/08/2010 1305	
<b>Prep Method: 7470A</b>		Date Prepared:	12/08/2010 0920	
Mercury	<0.00020	mg/L	0.00020	1.0
<b>Method: Dissolved-9014</b>		Date Analyzed:	12/09/2010 1608	
<b>Prep Method: 9010B</b>		Date Prepared:	12/09/2010 1250	
Cyanide, Total	<0.010	mg/L	0.010	1.0
<b>Method: Dissolved-9038</b>		Date Analyzed:	12/09/2010 0609	
Sulfate	180	mg/L	50	10
<b>Method: Dissolved-9251</b>		Date Analyzed:	12/13/2010 1704	
Chloride	140	mg/L	10	5.0
<b>Method: Dissolved-Nitrate by calc</b>		Date Analyzed:	12/15/2010 1641	
Nitrogen, Nitrate	1.9	mg/L	0.10	1.0
<b>Method: Dissolved-SM 2540C</b>		Date Analyzed:	12/08/2010 2329	

James DiCola  
 Midwest Generation EME LLC  
 1800 Channahon Road  
 Joliet, IL 60436

Job Number: 500-29703-1

**Client Sample ID: MW-01**  
**Lab Sample ID: 500-29703-1**

Date Sampled: 12/06/2010 1425  
 Date Received: 12/07/2010 1250  
 Client Matrix: Water

Analyte	Result/Qualifier	Unit	RL	Dilution
Total Dissolved Solids	590	mg/L	10	1.0
<b>Method: Dissolved-SM 4500 F C</b> Fluoride	0.45	mg/L	Date Analyzed: 12/13/2010 1218 0.10	1.0
<b>Method: Dissolved-SM 4500 NO2 B</b> Nitrogen, Nitrite	<0.020	mg/L	Date Analyzed: 12/08/2010 1043 0.020	1.0
<b>Method: Dissolved-SM 4500 NO3 F</b> Nitrogen, Nitrate Nitrite	1.9	mg/L	Date Analyzed: 12/14/2010 1610 0.20	2.0

James DiCola  
 Midwest Generation EME LLC  
 1800 Channahon Road  
 Joliet, IL 60436

Job Number: 500-29703-1

**Client Sample ID: MW-02**  
**Lab Sample ID: 500-29703-2**

Date Sampled: 12/06/2010 1345  
 Date Received: 12/07/2010 1250  
 Client Matrix: Water

Analyte	Result/Qualifier	Unit	RL	Dilution
<b>Method: Dissolved-6020</b>		Date Analyzed:	12/13/2010 2056	
<b>Prep Method: Soluble Metals</b>		Date Prepared:	12/08/2010 1252	
Beryllium	<0.0010	mg/L	0.0010	1.0
Boron	0.31	mg/L	0.050	1.0
<b>Method: Dissolved-6020</b>		Date Analyzed:	12/14/2010 1955	
<b>Prep Method: Soluble Metals</b>		Date Prepared:	12/08/2010 1252	
Arsenic	<0.0010	mg/L	0.0010	1.0
Barium	0.082	mg/L	0.0025	1.0
Cadmium	<0.00050	mg/L	0.00050	1.0
Chromium	<0.0050	mg/L	0.0050	1.0
Cobalt	<0.0010	mg/L	0.0010	1.0
Copper	0.0032	mg/L	0.0020	1.0
Iron	<0.10	mg/L	0.10	1.0
Lead	<0.00050	mg/L	0.00050	1.0
Manganese	<0.0025	mg/L	0.0025	1.0
Nickel	0.0033	mg/L	0.0020	1.0
Selenium	<0.0025	mg/L	0.0025	1.0
Silver	<0.00050	mg/L	0.00050	1.0
Thallium	<0.0020	mg/L	0.0020	1.0
Zinc	<0.020	mg/L	0.020	1.0
<b>Method: Dissolved-6020</b>		Date Analyzed:	12/17/2010 1028	
<b>Prep Method: Soluble Metals</b>		Date Prepared:	12/08/2010 1252	
Antimony	0.012	mg/L	0.0030	1.0
<b>Method: Dissolved-7470A</b>		Date Analyzed:	12/08/2010 1312	
<b>Prep Method: 7470A</b>		Date Prepared:	12/08/2010 0920	
Mercury	<0.00020	mg/L	0.00020	1.0
<b>Method: Dissolved-9014</b>		Date Analyzed:	12/09/2010 1609	
<b>Prep Method: 9010B</b>		Date Prepared:	12/09/2010 1250	
Cyanide, Total	<0.010	mg/L	0.010	1.0
<b>Method: Dissolved-9038</b>		Date Analyzed:	12/09/2010 0610	
Sulfate	190	mg/L	50	10
<b>Method: Dissolved-9251</b>		Date Analyzed:	12/13/2010 1705	
Chloride	140	mg/L	10	5.0
<b>Method: Dissolved-Nitrate by calc</b>		Date Analyzed:	12/15/2010 1641	
Nitrogen, Nitrate	3.1	mg/L	0.10	1.0
<b>Method: Dissolved-SM 2540C</b>		Date Analyzed:	12/08/2010 2335	

James DiCola  
 Midwest Generation EME LLC  
 1800 Channahon Road  
 Joliet, IL 60436

Job Number: 500-29703-1

**Client Sample ID: MW-02**  
**Lab Sample ID: 500-29703-2**

Date Sampled: 12/06/2010 1345  
 Date Received: 12/07/2010 1250  
 Client Matrix: Water

Analyte	Result/Qualifier	Unit	RL	Dilution
Total Dissolved Solids	600	mg/L	10	1.0
<b>Method: Dissolved-SM 4500 F C</b>			Date Analyzed: 12/13/2010 1226	
Fluoride	0.62	mg/L	0.10	1.0
<b>Method: Dissolved-SM 4500 NO2 B</b>			Date Analyzed: 12/08/2010 1044	
Nitrogen, Nitrite	<0.020	mg/L	0.020	1.0
<b>Method: Dissolved-SM 4500 NO3 F</b>			Date Analyzed: 12/14/2010 1611	
Nitrogen, Nitrate Nitrite	3.1	mg/L	0.20	2.0

James DiCola  
 Midwest Generation EME LLC  
 1800 Channahon Road  
 Joliet, IL 60436

Job Number: 500-29703-1

**Client Sample ID: MW-03**  
**Lab Sample ID: 500-29703-3**

Date Sampled: 12/07/2010 1010  
 Date Received: 12/07/2010 1250  
 Client Matrix: Water

Analyte	Result/Qualifier	Unit	RL	Dilution
<b>Method: Dissolved-6020</b>		Date Analyzed:	12/13/2010 2057	
<b>Prep Method: Soluble Metals</b>		Date Prepared:	12/08/2010 1252	
Beryllium	<0.0010	mg/L	0.0010	1.0
Boron	0.24	mg/L	0.050	1.0
<b>Method: Dissolved-6020</b>		Date Analyzed:	12/14/2010 1957	
<b>Prep Method: Soluble Metals</b>		Date Prepared:	12/08/2010 1252	
Arsenic	<0.0010	mg/L	0.0010	1.0
Barium	0.089	mg/L	0.0025	1.0
Cadmium	<0.00050	mg/L	0.00050	1.0
Chromium	<0.0050	mg/L	0.0050	1.0
Cobalt	0.0013	mg/L	0.0010	1.0
Copper	<0.0020	mg/L	0.0020	1.0
Iron	<0.10	mg/L	0.10	1.0
Lead	<0.00050	mg/L	0.00050	1.0
Manganese	0.10	mg/L	0.0025	1.0
Nickel	0.011	mg/L	0.0020	1.0
Selenium	<0.0025	mg/L	0.0025	1.0
Silver	<0.00050	mg/L	0.00050	1.0
Thallium	<0.0020	mg/L	0.0020	1.0
Zinc	<0.020	mg/L	0.020	1.0
<b>Method: Dissolved-6020</b>		Date Analyzed:	12/17/2010 1029	
<b>Prep Method: Soluble Metals</b>		Date Prepared:	12/08/2010 1252	
Antimony	0.0040	mg/L	0.0030	1.0
<b>Method: Dissolved-7470A</b>		Date Analyzed:	12/08/2010 1313	
<b>Prep Method: 7470A</b>		Date Prepared:	12/08/2010 0920	
Mercury	<0.00020	mg/L	0.00020	1.0
<b>Method: Dissolved-9014</b>		Date Analyzed:	12/09/2010 1609	
<b>Prep Method: 9010B</b>		Date Prepared:	12/09/2010 1250	
Cyanide, Total	<0.010	mg/L	0.010	1.0
<b>Method: Dissolved-9038</b>		Date Analyzed:	12/09/2010 0611	
Sulfate	120	mg/L	50	10
<b>Method: Dissolved-9251</b>		Date Analyzed:	12/13/2010 1705	
Chloride	260	mg/L	10	5.0
<b>Method: Dissolved-Nitrate by calc</b>		Date Analyzed:	12/15/2010 1641	
Nitrogen, Nitrate	<0.10	mg/L	0.10	1.0
<b>Method: Dissolved-SM 2540C</b>		Date Analyzed:	12/08/2010 2337	



James DiCola  
 Midwest Generation EME LLC  
 1800 Channahon Road  
 Joliet, IL 60436

Job Number: 500-29703-1

**Client Sample ID: MW-03**  
**Lab Sample ID: 500-29703-3**

Date Sampled: 12/07/2010 1010  
 Date Received: 12/07/2010 1250  
 Client Matrix: Water

Analyte	Result/Qualifier	Unit	RL	Dilution
Total Dissolved Solids	930	mg/L	10	1.0
<b>Method: Dissolved-SM 4500 F C</b> Fluoride	0.43	mg/L	0.10	1.0
<b>Method: Dissolved-SM 4500 NO2 B</b> Nitrogen, Nitrite	<0.020	mg/L	0.020	1.0
<b>Method: Dissolved-SM 4500 NO3 F</b> Nitrogen, Nitrate Nitrite	<0.10	mg/L	0.10	1.0

James DiCola  
 Midwest Generation EME LLC  
 1800 Channahon Road  
 Joliet, IL 60436

Job Number: 500-29703-1

**Client Sample ID: MW-04**  
**Lab Sample ID: 500-29703-4**

Date Sampled: 12/07/2010 1100  
 Date Received: 12/07/2010 1250  
 Client Matrix: Water

Analyte	Result/Qualifier	Unit	RL	Dilution
<b>Method: Dissolved-6020</b>		Date Analyzed:	12/13/2010 2058	
<b>Prep Method: Soluble Metals</b>		Date Prepared:	12/08/2010 1252	
Beryllium	<0.0010	mg/L	0.0010	1.0
Boron	0.46	mg/L	0.050	1.0
<b>Method: Dissolved-6020</b>		Date Analyzed:	12/14/2010 2000	
<b>Prep Method: Soluble Metals</b>		Date Prepared:	12/08/2010 1252	
Arsenic	<0.0010	mg/L	0.0010	1.0
Barium	0.065	mg/L	0.0025	1.0
Cadmium	<0.00050	mg/L	0.00050	1.0
Chromium	<0.0050	mg/L	0.0050	1.0
Cobalt	<0.0010	mg/L	0.0010	1.0
Copper	<0.0020	mg/L	0.0020	1.0
Iron	<0.10	mg/L	0.10	1.0
Lead	<0.00050	mg/L	0.00050	1.0
Manganese	0.33	mg/L	0.0025	1.0
Nickel	0.0067	mg/L	0.0020	1.0
Selenium	0.0025	mg/L	0.0025	1.0
Silver	<0.00050	mg/L	0.00050	1.0
Thallium	<0.0020	mg/L	0.0020	1.0
Zinc	<0.020	mg/L	0.020	1.0
<b>Method: Dissolved-6020</b>		Date Analyzed:	12/17/2010 1046	
<b>Prep Method: Soluble Metals</b>		Date Prepared:	12/08/2010 1252	
Antimony	<0.0030	mg/L	0.0030	1.0
<b>Method: Dissolved-7470A</b>		Date Analyzed:	12/08/2010 1318	
<b>Prep Method: 7470A</b>		Date Prepared:	12/08/2010 0920	
Mercury	<0.00020	mg/L	0.00020	1.0
<b>Method: Dissolved-9014</b>		Date Analyzed:	12/09/2010 1609	
<b>Prep Method: 9010B</b>		Date Prepared:	12/09/2010 1250	
Cyanide, Total	<0.010	mg/L	0.010	1.0
<b>Method: Dissolved-9038</b>		Date Analyzed:	12/09/2010 0707	
Sulfate	300	mg/L	50	10
<b>Method: Dissolved-9251</b>		Date Analyzed:	12/13/2010 1706	
Chloride	270	mg/L	10	5.0
<b>Method: Dissolved-Nitrate by calc</b>		Date Analyzed:	12/15/2010 1641	
Nitrogen, Nitrate	0.81	mg/L	0.10	1.0
<b>Method: Dissolved-SM 2540C</b>		Date Analyzed:	12/08/2010 2339	

James DiCola  
 Midwest Generation EME LLC  
 1800 Channahon Road  
 Joliet, IL 60436

Job Number: 500-29703-1

**Client Sample ID: MW-04**  
**Lab Sample ID: 500-29703-4**

Date Sampled: 12/07/2010 1100  
 Date Received: 12/07/2010 1250  
 Client Matrix: Water

Analyte	Result/Qualifier	Unit	RL	Dilution
Total Dissolved Solids	1100	mg/L	10	1.0
<b>Method: Dissolved-SM 4500 F C</b> Fluoride	0.49	mg/L	0.10	1.0
<b>Method: Dissolved-SM 4500 NO2 B</b> Nitrogen, Nitrite	<0.020	mg/L	0.020	1.0
<b>Method: Dissolved-SM 4500 NO3 F</b> Nitrogen, Nitrate Nitrite	0.81	mg/L	0.10	1.0

James DiCola  
 Midwest Generation EME LLC  
 1800 Channahon Road  
 Joliet, IL 60436

Job Number: 500-29703-1

**Client Sample ID: MW-05**  
**Lab Sample ID: 500-29703-5**

Date Sampled: 12/07/2010 1145  
 Date Received: 12/07/2010 1250  
 Client Matrix: Water

Analyte	Result/Qualifier	Unit	RL	Dilution
<b>Method: Dissolved-6020</b>		Date Analyzed:	12/13/2010 2059	
<b>Prep Method: Soluble Metals</b>		Date Prepared:	12/08/2010 1252	
Beryllium	<0.0010	mg/L	0.0010	1.0
Boron	0.42	mg/L	0.050	1.0
<b>Method: Dissolved-6020</b>		Date Analyzed:	12/14/2010 2003	
<b>Prep Method: Soluble Metals</b>		Date Prepared:	12/08/2010 1252	
Arsenic	<0.0010	mg/L	0.0010	1.0
Barium	0.061	mg/L	0.0025	1.0
Cadmium	<0.00050	mg/L	0.00050	1.0
Chromium	<0.0050	mg/L	0.0050	1.0
Cobalt	<0.0010	mg/L	0.0010	1.0
Copper	<0.0020	mg/L	0.0020	1.0
Iron	<0.10	mg/L	0.10	1.0
Lead	<0.00050	mg/L	0.00050	1.0
Manganese	0.0065	mg/L	0.0025	1.0
Nickel	<0.0020	mg/L	0.0020	1.0
Selenium	<0.0025	mg/L	0.0025	1.0
Silver	<0.00050	mg/L	0.00050	1.0
Thallium	<0.0020	mg/L	0.0020	1.0
Zinc	<0.020	mg/L	0.020	1.0
<b>Method: Dissolved-6020</b>		Date Analyzed:	12/17/2010 1039	
<b>Prep Method: Soluble Metals</b>		Date Prepared:	12/08/2010 1252	
Antimony	<0.0030	mg/L	0.0030	1.0
<b>Method: Dissolved-7470A</b>		Date Analyzed:	12/08/2010 1320	
<b>Prep Method: 7470A</b>		Date Prepared:	12/08/2010 0920	
Mercury	<0.00020	mg/L	0.00020	1.0
<b>Method: Dissolved-9014</b>		Date Analyzed:	12/09/2010 1609	
<b>Prep Method: 9010B</b>		Date Prepared:	12/09/2010 1250	
Cyanide, Total	<0.010	mg/L	0.010	1.0
<b>Method: Dissolved-9038</b>		Date Analyzed:	12/09/2010 0708	
Sulfate	110	mg/L	25	5.0
<b>Method: Dissolved-9251</b>		Date Analyzed:	12/13/2010 1706	
Chloride	150	mg/L	10	5.0
<b>Method: Dissolved-Nitrate by calc</b>		Date Analyzed:	12/15/2010 1641	
Nitrogen, Nitrate	<0.10	mg/L	0.10	1.0
<b>Method: Dissolved-SM 2540C</b>		Date Analyzed:	12/08/2010 2341	

James DiCola  
 Midwest Generation EME LLC  
 1800 Channahon Road  
 Joliet, IL 60436

Job Number: 500-29703-1

**Client Sample ID: MW-05**  
**Lab Sample ID: 500-29703-5**

Date Sampled: 12/07/2010 1145  
 Date Received: 12/07/2010 1250  
 Client Matrix: Water

Analyte	Result/Qualifier	Unit	RL	Dilution
Total Dissolved Solids	750	mg/L	10	1.0
<b>Method: Dissolved-SM 4500 F C</b>			Date Analyzed: 12/13/2010 1237	
Fluoride	0.40	mg/L	0.10	1.0
<b>Method: Dissolved-SM 4500 NO2 B</b>			Date Analyzed: 12/08/2010 1046	
Nitrogen, Nitrite	<0.020	mg/L	0.020	1.0
<b>Method: Dissolved-SM 4500 NO3 F</b>			Date Analyzed: 12/15/2010 1458	
Nitrogen, Nitrate Nitrite	<0.10	mg/L	0.10	1.0

James DiCola  
 Midwest Generation EME LLC  
 1800 Channahon Road  
 Joliet, IL 60436

Job Number: 500-29703-1

**Client Sample ID: MW-06**  
**Lab Sample ID: 500-29703-6**

Date Sampled: 12/07/2010 0930  
 Date Received: 12/07/2010 1250  
 Client Matrix: Water

Analyte	Result/Qualifier	Unit	RL	Dilution
<b>Method: Dissolved-6020</b>		Date Analyzed:	12/13/2010 2100	
<b>Prep Method: Soluble Metals</b>		Date Prepared:	12/08/2010 1252	
Beryllium	<0.0010	mg/L	0.0010	1.0
Boron	0.32	mg/L	0.050	1.0
<b>Method: Dissolved-6020</b>		Date Analyzed:	12/14/2010 2005	
<b>Prep Method: Soluble Metals</b>		Date Prepared:	12/08/2010 1252	
Arsenic	<0.0010	mg/L	0.0010	1.0
Barium	0.075	mg/L	0.0025	1.0
Cadmium	<0.00050	mg/L	0.00050	1.0
Chromium	<0.0050	mg/L	0.0050	1.0
Cobalt	<0.0010	mg/L	0.0010	1.0
Copper	<0.0020	mg/L	0.0020	1.0
Iron	<0.10	mg/L	0.10	1.0
Lead	<0.00050	mg/L	0.00050	1.0
Manganese	0.14	mg/L	0.0025	1.0
Nickel	0.0056	mg/L	0.0020	1.0
Selenium	0.0029	mg/L	0.0025	1.0
Silver	<0.00050	mg/L	0.00050	1.0
Thallium	<0.0020	mg/L	0.0020	1.0
Zinc	<0.020	mg/L	0.020	1.0
<b>Method: Dissolved-6020</b>		Date Analyzed:	12/17/2010 1040	
<b>Prep Method: Soluble Metals</b>		Date Prepared:	12/08/2010 1252	
Antimony	<0.0030	mg/L	0.0030	1.0
<b>Method: Dissolved-7470A</b>		Date Analyzed:	12/08/2010 1322	
<b>Prep Method: 7470A</b>		Date Prepared:	12/08/2010 0920	
Mercury	<0.00020	mg/L	0.00020	1.0
<b>Method: Dissolved-9014</b>		Date Analyzed:	12/09/2010 1610	
<b>Prep Method: 9010B</b>		Date Prepared:	12/09/2010 1250	
Cyanide, Total	<0.010	mg/L	0.010	1.0
<b>Method: Dissolved-9038</b>		Date Analyzed:	12/09/2010 0709	
Sulfate	140	mg/L	50	10
<b>Method: Dissolved-9251</b>		Date Analyzed:	12/13/2010 1707	
Chloride	130	mg/L	10	5.0
<b>Method: Dissolved-Nitrate by calc</b>		Date Analyzed:	12/15/2010 1641	
Nitrogen, Nitrate	<0.10	mg/L	0.10	1.0
<b>Method: Dissolved-SM 2540C</b>		Date Analyzed:	12/08/2010 2343	



James DiCola  
 Midwest Generation EME LLC  
 1800 Channahon Road  
 Joliet, IL 60436

Job Number: 500-29703-1

**Client Sample ID: MW-06**  
**Lab Sample ID: 500-29703-6**

Date Sampled: 12/07/2010 0930  
 Date Received: 12/07/2010 1250  
 Client Matrix: Water

Analyte	Result/Qualifier	Unit	RL	Dilution
Total Dissolved Solids	650	mg/L	10	1.0
<b>Method: Dissolved-SM 4500 F C</b> Fluoride	0.40	mg/L	Date Analyzed: 12/13/2010 1240 0.10	1.0
<b>Method: Dissolved-SM 4500 NO2 B</b> Nitrogen, Nitrite	<0.020	mg/L	Date Analyzed: 12/08/2010 1046 0.020	1.0
<b>Method: Dissolved-SM 4500 NO3 F</b> Nitrogen, Nitrate Nitrite	<0.10 ^	mg/L	Date Analyzed: 12/14/2010 1534 0.10	1.0

James DiCola  
 Midwest Generation EME LLC  
 1800 Channahon Road  
 Joliet, IL 60436

Job Number: 500-29703-1

**Client Sample ID: MW-07**  
**Lab Sample ID: 500-29703-7**

Date Sampled: 12/07/2010 0855  
 Date Received: 12/07/2010 1250  
 Client Matrix: Water

Analyte	Result/Qualifier	Unit	RL	Dilution
<b>Method: Dissolved-6020</b>		Date Analyzed:	12/13/2010 2101	
<b>Prep Method: Soluble Metals</b>		Date Prepared:	12/08/2010 1252	
Beryllium	<0.0010	mg/L	0.0010	1.0
Boron	0.51	mg/L	0.050	1.0
<b>Method: Dissolved-6020</b>		Date Analyzed:	12/14/2010 2008	
<b>Prep Method: Soluble Metals</b>		Date Prepared:	12/08/2010 1252	
Arsenic	0.0010	mg/L	0.0010	1.0
Barium	0.13	mg/L	0.0025	1.0
Cadmium	<0.00050	mg/L	0.00050	1.0
Chromium	<0.0050	mg/L	0.0050	1.0
Cobalt	<0.0010	mg/L	0.0010	1.0
Copper	<0.0020	mg/L	0.0020	1.0
Iron	<0.10	mg/L	0.10	1.0
Lead	<0.00050	mg/L	0.00050	1.0
Manganese	0.29	mg/L	0.0025	1.0
Nickel	0.0045	mg/L	0.0020	1.0
Selenium	<0.0025	mg/L	0.0025	1.0
Silver	<0.00050	mg/L	0.00050	1.0
Thallium	<0.0020	mg/L	0.0020	1.0
Zinc	<0.020	mg/L	0.020	1.0
<b>Method: Dissolved-6020</b>		Date Analyzed:	12/17/2010 1040	
<b>Prep Method: Soluble Metals</b>		Date Prepared:	12/08/2010 1252	
Antimony	<0.0030	mg/L	0.0030	1.0
<b>Method: Dissolved-7470A</b>		Date Analyzed:	12/08/2010 1324	
<b>Prep Method: 7470A</b>		Date Prepared:	12/08/2010 0920	
Mercury	<0.00020	mg/L	0.00020	1.0
<b>Method: Dissolved-9014</b>		Date Analyzed:	12/09/2010 1610	
<b>Prep Method: 9010B</b>		Date Prepared:	12/09/2010 1250	
Cyanide, Total	<0.010	mg/L	0.010	1.0
<b>Method: Dissolved-9038</b>		Date Analyzed:	12/09/2010 0710	
Sulfate	250	mg/L	50	10
<b>Method: Dissolved-9251</b>		Date Analyzed:	12/13/2010 1707	
Chloride	430	mg/L	50	25
<b>Method: Dissolved-Nitrate by calc</b>		Date Analyzed:	12/15/2010 1641	
Nitrogen, Nitrate	<0.10	mg/L	0.10	1.0
<b>Method: Dissolved-SM 2540C</b>		Date Analyzed:	12/08/2010 2345	

James DiCola  
 Midwest Generation EME LLC  
 1800 Channahon Road  
 Joliet, IL 60436

Job Number: 500-29703-1

**Client Sample ID: MW-07**  
**Lab Sample ID: 500-29703-7**

Date Sampled: 12/07/2010 0855  
 Date Received: 12/07/2010 1250  
 Client Matrix: Water

Analyte	Result/Qualifier	Unit	RL	Dilution
Total Dissolved Solids	1200	mg/L	10	1.0
<b>Method: Dissolved-SM 4500 F C</b>		Date Analyzed:	12/13/2010 1244	
Fluoride	0.36	mg/L	0.10	1.0
<b>Method: Dissolved-SM 4500 NO2 B</b>		Date Analyzed:	12/08/2010 1047	
Nitrogen, Nitrite	<0.020	mg/L	0.020	1.0
<b>Method: Dissolved-SM 4500 NO3 F</b>		Date Analyzed:	12/14/2010 1536	
Nitrogen, Nitrate Nitrite	<0.10 ^	mg/L	0.10	1.0

James DiCola  
 Midwest Generation EME LLC  
 1800 Channahon Road  
 Joliet, IL 60436

Job Number: 500-29703-1

**Client Sample ID: MW-08**  
**Lab Sample ID: 500-29703-8**

Date Sampled: 12/06/2010 1455  
 Date Received: 12/07/2010 1250  
 Client Matrix: Water

Analyte	Result/Qualifier	Unit	RL	Dilution
<b>Method: Dissolved-6020</b>		Date Analyzed:	12/13/2010 2102	
<b>Prep Method: Soluble Metals</b>		Date Prepared:	12/08/2010 1252	
Beryllium	<0.0010	mg/L	0.0010	1.0
Boron	0.29	mg/L	0.050	1.0
<b>Method: Dissolved-6020</b>		Date Analyzed:	12/14/2010 2011	
<b>Prep Method: Soluble Metals</b>		Date Prepared:	12/08/2010 1252	
Arsenic	<0.0010	mg/L	0.0010	1.0
Barium	0.054	mg/L	0.0025	1.0
Cadmium	<0.00050	mg/L	0.00050	1.0
Chromium	<0.0050	mg/L	0.0050	1.0
Cobalt	<0.0010	mg/L	0.0010	1.0
Copper	<0.0020	mg/L	0.0020	1.0
Iron	<0.10	mg/L	0.10	1.0
Lead	<0.00050	mg/L	0.00050	1.0
Manganese	0.0051	mg/L	0.0025	1.0
Nickel	0.0025	mg/L	0.0020	1.0
Selenium	<0.0025	mg/L	0.0025	1.0
Silver	<0.00050	mg/L	0.00050	1.0
Thallium	<0.0020	mg/L	0.0020	1.0
Zinc	<0.020	mg/L	0.020	1.0
<b>Method: Dissolved-6020</b>		Date Analyzed:	12/17/2010 1041	
<b>Prep Method: Soluble Metals</b>		Date Prepared:	12/08/2010 1252	
Antimony	<0.0030	mg/L	0.0030	1.0
<b>Method: Dissolved-7470A</b>		Date Analyzed:	12/08/2010 1325	
<b>Prep Method: 7470A</b>		Date Prepared:	12/08/2010 0920	
Mercury	<0.00020	mg/L	0.00020	1.0
<b>Method: Dissolved-9014</b>		Date Analyzed:	12/09/2010 1610	
<b>Prep Method: 9010B</b>		Date Prepared:	12/09/2010 1250	
Cyanide, Total	<0.010	mg/L	0.010	1.0
<b>Method: Dissolved-9038</b>		Date Analyzed:	12/09/2010 0711	
Sulfate	210	mg/L	50	10
<b>Method: Dissolved-9251</b>		Date Analyzed:	12/13/2010 1708	
Chloride	130	mg/L	10	5.0
<b>Method: Dissolved-Nitrate by calc</b>		Date Analyzed:	12/15/2010 1641	
Nitrogen, Nitrate	0.33	mg/L	0.10	1.0
<b>Method: Dissolved-SM 2540C</b>		Date Analyzed:	12/08/2010 2347	

James DiCola  
 Midwest Generation EME LLC  
 1800 Channahon Road  
 Joliet, IL 60436

Job Number: 500-29703-1

**Client Sample ID: MW-08**  
**Lab Sample ID: 500-29703-8**

Date Sampled: 12/06/2010 1455  
 Date Received: 12/07/2010 1250  
 Client Matrix: Water

Analyte	Result/Qualifier	Unit	RL	Dilution
Total Dissolved Solids	670	mg/L	10	1.0
<b>Method: Dissolved-SM 4500 F C</b> Fluoride	0.51	mg/L	Date Analyzed: 12/13/2010 1247 0.10	1.0
<b>Method: Dissolved-SM 4500 NO2 B</b> Nitrogen, Nitrite	<0.020	mg/L	Date Analyzed: 12/08/2010 1047 0.020	1.0
<b>Method: Dissolved-SM 4500 NO3 F</b> Nitrogen, Nitrate Nitrite	0.33	mg/L	Date Analyzed: 12/14/2010 1612 0.10	1.0

James DiCola  
 Midwest Generation EME LLC  
 1800 Channahon Road  
 Joliet, IL 60436

Job Number: 500-29703-1

**Client Sample ID: MW-09**  
**Lab Sample ID: 500-29703-9**

Date Sampled: 12/06/2010 1115  
 Date Received: 12/07/2010 1250  
 Client Matrix: Water

Analyte	Result/Qualifier	Unit	RL	Dilution
<b>Method: Dissolved-6020</b>		Date Analyzed:	12/13/2010 2105	
<b>Prep Method: Soluble Metals</b>		Date Prepared:	12/08/2010 1252	
Beryllium	<0.0010	mg/L	0.0010	1.0
Boron	0.36	mg/L	0.050	1.0
<b>Method: Dissolved-6020</b>		Date Analyzed:	12/14/2010 2013	
<b>Prep Method: Soluble Metals</b>		Date Prepared:	12/08/2010 1252	
Arsenic	<0.0010	mg/L	0.0010	1.0
Barium	0.031	mg/L	0.0025	1.0
Cadmium	<0.00050	mg/L	0.00050	1.0
Chromium	<0.0050	mg/L	0.0050	1.0
Cobalt	0.0047	mg/L	0.0010	1.0
Copper	<0.0020	mg/L	0.0020	1.0
Iron	<0.10	mg/L	0.10	1.0
Lead	<0.00050	mg/L	0.00050	1.0
Manganese	1.1	mg/L	0.0025	1.0
Nickel	0.0094	mg/L	0.0020	1.0
Selenium	<0.0025	mg/L	0.0025	1.0
Silver	<0.00050	mg/L	0.00050	1.0
Thallium	<0.0020	mg/L	0.0020	1.0
Zinc	<0.020	mg/L	0.020	1.0
<b>Method: Dissolved-6020</b>		Date Analyzed:	12/17/2010 1042	
<b>Prep Method: Soluble Metals</b>		Date Prepared:	12/08/2010 1252	
Antimony	<0.0030	mg/L	0.0030	1.0
<b>Method: Dissolved-7470A</b>		Date Analyzed:	12/08/2010 1327	
<b>Prep Method: 7470A</b>		Date Prepared:	12/08/2010 0920	
Mercury	<0.00020	mg/L	0.00020	1.0
<b>Method: Dissolved-9014</b>		Date Analyzed:	12/09/2010 1611	
<b>Prep Method: 9010B</b>		Date Prepared:	12/09/2010 1250	
Cyanide, Total	<0.010	mg/L	0.010	1.0
<b>Method: Dissolved-9038</b>		Date Analyzed:	12/09/2010 0712	
Sulfate	1600	mg/L	250	50
<b>Method: Dissolved-9251</b>		Date Analyzed:	12/13/2010 1708	
Chloride	140	mg/L	10	5.0
<b>Method: Dissolved-Nitrate by calc</b>		Date Analyzed:	12/15/2010 1641	
Nitrogen, Nitrate	<0.10	mg/L	0.10	1.0
<b>Method: Dissolved-SM 2540C</b>		Date Analyzed:	12/08/2010 2349	

James DiCola  
 Midwest Generation EME LLC  
 1800 Channahon Road  
 Joliet, IL 60436

Job Number: 500-29703-1

**Client Sample ID: MW-09**  
**Lab Sample ID: 500-29703-9**

Date Sampled: 12/06/2010 1115  
 Date Received: 12/07/2010 1250  
 Client Matrix: Water

Analyte	Result/Qualifier	Unit	RL	Dilution
Total Dissolved Solids	2600	mg/L	10	1.0
<b>Method: Dissolved-SM 4500 F C</b>			Date Analyzed: 12/13/2010 1300	
Fluoride	0.61	mg/L	0.10	1.0
<b>Method: Dissolved-SM 4500 NO2 B</b>			Date Analyzed: 12/08/2010 1048	
Nitrogen, Nitrite	<0.020	mg/L	0.020	1.0
<b>Method: Dissolved-SM 4500 NO3 F</b>			Date Analyzed: 12/14/2010 1538	
Nitrogen, Nitrate Nitrite	<0.10 ^	mg/L	0.10	1.0



James DiCola  
 Midwest Generation EME LLC  
 1800 Channahon Road  
 Joliet, IL 60436

Job Number: 500-29703-1

**Client Sample ID: MW-10**  
**Lab Sample ID: 500-29703-10**

Date Sampled: 12/06/2010 1520  
 Date Received: 12/07/2010 1250  
 Client Matrix: Water

Analyte	Result/Qualifier	Unit	RL	Dilution
<b>Method: Dissolved-6020</b>		Date Analyzed:	12/13/2010 2106	
<b>Prep Method: Soluble Metals</b>		Date Prepared:	12/08/2010 1252	
Beryllium	<0.0010	mg/L	0.0010	1.0
Boron	0.50	mg/L	0.050	1.0
<b>Method: Dissolved-6020</b>		Date Analyzed:	12/14/2010 2016	
<b>Prep Method: Soluble Metals</b>		Date Prepared:	12/08/2010 1252	
Arsenic	<0.0010	mg/L	0.0010	1.0
Barium	0.050	mg/L	0.0025	1.0
Cadmium	<0.00050	mg/L	0.00050	1.0
Chromium	<0.0050	mg/L	0.0050	1.0
Cobalt	<0.0010	mg/L	0.0010	1.0
Copper	<0.0020	mg/L	0.0020	1.0
Iron	<0.10	mg/L	0.10	1.0
Lead	<0.00050	mg/L	0.00050	1.0
Manganese	0.12	mg/L	0.0025	1.0
Nickel	0.0052	mg/L	0.0020	1.0
Selenium	<0.0025	mg/L	0.0025	1.0
Silver	<0.00050	mg/L	0.00050	1.0
Thallium	<0.0020	mg/L	0.0020	1.0
Zinc	<0.020	mg/L	0.020	1.0
<b>Method: Dissolved-6020</b>		Date Analyzed:	12/17/2010 1043	
<b>Prep Method: Soluble Metals</b>		Date Prepared:	12/08/2010 1252	
Antimony	<0.0030	mg/L	0.0030	1.0
<b>Method: Dissolved-7470A</b>		Date Analyzed:	12/08/2010 1329	
<b>Prep Method: 7470A</b>		Date Prepared:	12/08/2010 0920	
Mercury	<0.00020	mg/L	0.00020	1.0
<b>Method: Dissolved-9014</b>		Date Analyzed:	12/09/2010 1611	
<b>Prep Method: 9010B</b>		Date Prepared:	12/09/2010 1250	
Cyanide, Total	<0.010	mg/L	0.010	1.0
<b>Method: Dissolved-9038</b>		Date Analyzed:	12/09/2010 0713	
Sulfate	130	mg/L	50	10
<b>Method: Dissolved-9251</b>		Date Analyzed:	12/13/2010 1709	
Chloride	200	mg/L	10	5.0
<b>Method: Dissolved-Nitrate by calc</b>		Date Analyzed:	12/15/2010 1641	
Nitrogen, Nitrate	0.39	mg/L	0.10	1.0
<b>Method: Dissolved-SM 2540C</b>		Date Analyzed:	12/08/2010 2351	

James DiCola  
 Midwest Generation EME LLC  
 1800 Channahon Road  
 Joliet, IL 60436

Job Number: 500-29703-1

**Client Sample ID: MW-10**  
**Lab Sample ID: 500-29703-10**

Date Sampled: 12/06/2010 1520  
 Date Received: 12/07/2010 1250  
 Client Matrix: Water

Analyte	Result/Qualifier	Unit	RL	Dilution
Total Dissolved Solids	860	mg/L	10	1.0
<b>Method: Dissolved-SM 4500 F C</b>			Date Analyzed: 12/13/2010 1303	
Fluoride	0.43	mg/L	0.10	1.0
<b>Method: Dissolved-SM 4500 NO2 B</b>			Date Analyzed: 12/08/2010 1048	
Nitrogen, Nitrite	<0.020	mg/L	0.020	1.0
<b>Method: Dissolved-SM 4500 NO3 F</b>			Date Analyzed: 12/15/2010 1505	
Nitrogen, Nitrate Nitrite	0.39	mg/L	0.10	1.0

James DiCola  
 Midwest Generation EME LLC  
 1800 Channahon Road  
 Joliet, IL 60436

Job Number: 500-29703-1

**Client Sample ID: MW-11**  
**Lab Sample ID: 500-29703-11**

Date Sampled: 12/06/2010 1600  
 Date Received: 12/07/2010 1250  
 Client Matrix: Water

Analyte	Result/Qualifier	Unit	RL	Dilution
<b>Method: Dissolved-6020</b>		Date Analyzed:	12/13/2010 2108	
<b>Prep Method: Soluble Metals</b>		Date Prepared:	12/08/2010 1252	
Beryllium	<0.0010	mg/L	0.0010	1.0
Boron	0.47	mg/L	0.050	1.0
<b>Method: Dissolved-6020</b>		Date Analyzed:	12/14/2010 2019	
<b>Prep Method: Soluble Metals</b>		Date Prepared:	12/08/2010 1252	
Arsenic	0.0013	mg/L	0.0010	1.0
Barium	0.064	mg/L	0.0025	1.0
Cadmium	<0.00050	mg/L	0.00050	1.0
Chromium	<0.0050	mg/L	0.0050	1.0
Cobalt	<0.0010	mg/L	0.0010	1.0
Copper	<0.0020	mg/L	0.0020	1.0
Iron	<0.10	mg/L	0.10	1.0
Lead	<0.00050	mg/L	0.00050	1.0
Manganese	0.052	mg/L	0.0025	1.0
Nickel	0.0022	mg/L	0.0020	1.0
Selenium	<0.0025	mg/L	0.0025	1.0
Silver	<0.00050	mg/L	0.00050	1.0
Thallium	<0.0020	mg/L	0.0020	1.0
Zinc	<0.020	mg/L	0.020	1.0
<b>Method: Dissolved-6020</b>		Date Analyzed:	12/17/2010 1044	
<b>Prep Method: Soluble Metals</b>		Date Prepared:	12/08/2010 1252	
Antimony	<0.0030	mg/L	0.0030	1.0
<b>Method: Dissolved-7470A</b>		Date Analyzed:	12/08/2010 1330	
<b>Prep Method: 7470A</b>		Date Prepared:	12/08/2010 0920	
Mercury	<0.00020	mg/L	0.00020	1.0
<b>Method: Dissolved-9014</b>		Date Analyzed:	12/09/2010 1611	
<b>Prep Method: 9010B</b>		Date Prepared:	12/09/2010 1250	
Cyanide, Total	<0.010	mg/L	0.010	1.0
<b>Method: Dissolved-9038</b>		Date Analyzed:	12/09/2010 0714	
Sulfate	140	mg/L	50	10
<b>Method: Dissolved-9251</b>		Date Analyzed:	12/13/2010 1710	
Chloride	160	mg/L	10	5.0
<b>Method: Dissolved-Nitrate by calc</b>		Date Analyzed:	12/15/2010 1641	
Nitrogen, Nitrate	0.39	mg/L	0.10	1.0
<b>Method: Dissolved-SM 2540C</b>		Date Analyzed:	12/08/2010 2353	

James DiCola  
 Midwest Generation EME LLC  
 1800 Channahon Road  
 Joliet, IL 60436

Job Number: 500-29703-1

**Client Sample ID: MW-11**  
**Lab Sample ID: 500-29703-11**

Date Sampled: 12/06/2010 1600  
 Date Received: 12/07/2010 1250  
 Client Matrix: Water

Analyte	Result/Qualifier	Unit	RL	Dilution
Total Dissolved Solids	770	mg/L	10	1.0
<b>Method: Dissolved-SM 4500 F C</b> Fluoride	0.34	mg/L	Date Analyzed: 12/13/2010 1307 0.10	1.0
<b>Method: Dissolved-SM 4500 NO2 B</b> Nitrogen, Nitrite	<0.020	mg/L	Date Analyzed: 12/08/2010 1048 0.020	1.0
<b>Method: Dissolved-SM 4500 NO3 F</b> Nitrogen, Nitrate Nitrite	0.39	mg/L	Date Analyzed: 12/15/2010 1507 0.10	1.0

**DATA REPORTING QUALIFIERS**

Client: Midwest Generation EME LLC

Job Number: 500-29703-1

<b>Lab Section</b>	<b>Qualifier</b>	<b>Description</b>
Metals	F	MS or MSD exceeds the control limits
General Chemistry	^	ICV,CCV,ICB,CCB, ISA, ISB, CRI, CRA, DLCK or MRL standard: Instrument related QC exceeds the control limits.

# **QUALITY CONTROL RESULTS**

## Quality Control Results

Client: Midwest Generation EME LLC

Job Number: 500-29703-1

## QC Association Summary

Lab Sample ID	Client Sample ID	Report Basis	Client Matrix	Method	Prep Batch
<b>Metals</b>					
<b>Prep Batch: 500-101452</b>					
LCS 500-101452/8-A	Lab Control Sample	T	Water	7470A	
MB 500-101452/7-A	Method Blank	T	Water	7470A	
500-29703-1	MW-01	D	Water	7470A	
500-29703-1DU	Duplicate	D	Water	7470A	
500-29703-1MS	Matrix Spike	D	Water	7470A	
500-29703-1MSD	Matrix Spike Duplicate	D	Water	7470A	
500-29703-2	MW-02	D	Water	7470A	
500-29703-3	MW-03	D	Water	7470A	
500-29703-4	MW-04	D	Water	7470A	
500-29703-5	MW-05	D	Water	7470A	
500-29703-6	MW-06	D	Water	7470A	
500-29703-7	MW-07	D	Water	7470A	
500-29703-8	MW-08	D	Water	7470A	
500-29703-9	MW-09	D	Water	7470A	
500-29703-10	MW-10	D	Water	7470A	
500-29703-11	MW-11	D	Water	7470A	
<b>Prep Batch: 500-101483</b>					
LCS 500-101483/2-A	Lab Control Sample	S	Water	Soluble Metals	
MB 500-101483/1-A	Method Blank	S	Water	Soluble Metals	
500-29703-1	MW-01	D	Water	Soluble Metals	
500-29703-1DU	Duplicate	D	Water	Soluble Metals	
500-29703-1MS	Matrix Spike	D	Water	Soluble Metals	
500-29703-1MSD	Matrix Spike Duplicate	D	Water	Soluble Metals	
500-29703-2	MW-02	D	Water	Soluble Metals	
500-29703-3	MW-03	D	Water	Soluble Metals	
500-29703-4	MW-04	D	Water	Soluble Metals	
500-29703-5	MW-05	D	Water	Soluble Metals	
500-29703-6	MW-06	D	Water	Soluble Metals	
500-29703-7	MW-07	D	Water	Soluble Metals	
500-29703-8	MW-08	D	Water	Soluble Metals	
500-29703-9	MW-09	D	Water	Soluble Metals	
500-29703-10	MW-10	D	Water	Soluble Metals	
500-29703-11	MW-11	D	Water	Soluble Metals	



## Quality Control Results

Client: Midwest Generation EME LLC

Job Number: 500-29703-1

## QC Association Summary

Lab Sample ID	Client Sample ID	Report Basis	Client Matrix	Method	Prep Batch
<b>Metals</b>					
<b>Analysis Batch:500-101510</b>					
LCS 500-101452/8-A	Lab Control Sample	T	Water	7470A	500-101452
MB 500-101452/7-A	Method Blank	T	Water	7470A	500-101452
500-29703-1	MW-01	D	Water	7470A	500-101452
500-29703-1DU	Duplicate	D	Water	7470A	500-101452
500-29703-1MS	Matrix Spike	D	Water	7470A	500-101452
500-29703-1MSD	Matrix Spike Duplicate	D	Water	7470A	500-101452
500-29703-2	MW-02	D	Water	7470A	500-101452
500-29703-3	MW-03	D	Water	7470A	500-101452
500-29703-4	MW-04	D	Water	7470A	500-101452
500-29703-5	MW-05	D	Water	7470A	500-101452
500-29703-6	MW-06	D	Water	7470A	500-101452
500-29703-7	MW-07	D	Water	7470A	500-101452
500-29703-8	MW-08	D	Water	7470A	500-101452
500-29703-9	MW-09	D	Water	7470A	500-101452
500-29703-10	MW-10	D	Water	7470A	500-101452
500-29703-11	MW-11	D	Water	7470A	500-101452
<b>Analysis Batch:500-101835</b>					
LCS 500-101483/2-A	Lab Control Sample	S	Water	6020	500-101483
MB 500-101483/1-A	Method Blank	S	Water	6020	500-101483
500-29703-1	MW-01	D	Water	6020	500-101483
500-29703-1DU	Duplicate	D	Water	6020	500-101483
500-29703-1MS	Matrix Spike	D	Water	6020	500-101483
500-29703-1MSD	Matrix Spike Duplicate	D	Water	6020	500-101483
500-29703-2	MW-02	D	Water	6020	500-101483
500-29703-3	MW-03	D	Water	6020	500-101483
500-29703-4	MW-04	D	Water	6020	500-101483
500-29703-5	MW-05	D	Water	6020	500-101483
500-29703-6	MW-06	D	Water	6020	500-101483
500-29703-7	MW-07	D	Water	6020	500-101483
500-29703-8	MW-08	D	Water	6020	500-101483
500-29703-9	MW-09	D	Water	6020	500-101483
500-29703-10	MW-10	D	Water	6020	500-101483
500-29703-11	MW-11	D	Water	6020	500-101483

## Quality Control Results

Client: Midwest Generation EME LLC

Job Number: 500-29703-1

## QC Association Summary

Lab Sample ID	Client Sample ID	Report Basis	Client Matrix	Method	Prep Batch
<b>Metals</b>					
<b>Analysis Batch:500-101913</b>					
LCS 500-101483/2-A	Lab Control Sample	S	Water	6020	500-101483
MB 500-101483/1-A	Method Blank	S	Water	6020	500-101483
500-29703-1	MW-01	D	Water	6020	500-101483
500-29703-1DU	Duplicate	D	Water	6020	500-101483
500-29703-1MS	Matrix Spike	D	Water	6020	500-101483
500-29703-1MSD	Matrix Spike Duplicate	D	Water	6020	500-101483
500-29703-2	MW-02	D	Water	6020	500-101483
500-29703-3	MW-03	D	Water	6020	500-101483
500-29703-4	MW-04	D	Water	6020	500-101483
500-29703-5	MW-05	D	Water	6020	500-101483
500-29703-6	MW-06	D	Water	6020	500-101483
500-29703-7	MW-07	D	Water	6020	500-101483
500-29703-8	MW-08	D	Water	6020	500-101483
500-29703-9	MW-09	D	Water	6020	500-101483
500-29703-10	MW-10	D	Water	6020	500-101483
500-29703-11	MW-11	D	Water	6020	500-101483
<b>Analysis Batch:500-102128</b>					
LCS 500-101483/2-A	Lab Control Sample	S	Water	6020	500-101483
MB 500-101483/1-A	Method Blank	S	Water	6020	500-101483
500-29703-1	MW-01	D	Water	6020	500-101483
500-29703-1DU	Duplicate	D	Water	6020	500-101483
500-29703-1MS	Matrix Spike	D	Water	6020	500-101483
500-29703-1MSD	Matrix Spike Duplicate	D	Water	6020	500-101483
500-29703-2	MW-02	D	Water	6020	500-101483
500-29703-3	MW-03	D	Water	6020	500-101483
500-29703-4	MW-04	D	Water	6020	500-101483
500-29703-5	MW-05	D	Water	6020	500-101483
500-29703-6	MW-06	D	Water	6020	500-101483
500-29703-7	MW-07	D	Water	6020	500-101483
500-29703-8	MW-08	D	Water	6020	500-101483
500-29703-9	MW-09	D	Water	6020	500-101483
500-29703-10	MW-10	D	Water	6020	500-101483
500-29703-11	MW-11	D	Water	6020	500-101483

**Report Basis**

D = Dissolved

S = Soluble

T = Total

## Quality Control Results

Client: Midwest Generation EME LLC

Job Number: 500-29703-1

## QC Association Summary

Lab Sample ID	Client Sample ID	Report Basis	Client Matrix	Method	Prep Batch
<b>General Chemistry</b>					
<b>Analysis Batch:500-101499</b>					
LCS 500-101499/4	Lab Control Sample	T	Water	SM 4500 NO2 B	
MB 500-101499/3	Method Blank	T	Water	SM 4500 NO2 B	
500-29703-1	MW-01	D	Water	SM 4500 NO2 B	
500-29703-1MS	Matrix Spike	D	Water	SM 4500 NO2 B	
500-29703-1MSD	Matrix Spike Duplicate	D	Water	SM 4500 NO2 B	
500-29703-2	MW-02	D	Water	SM 4500 NO2 B	
500-29703-3	MW-03	D	Water	SM 4500 NO2 B	
500-29703-4	MW-04	D	Water	SM 4500 NO2 B	
500-29703-5	MW-05	D	Water	SM 4500 NO2 B	
500-29703-6	MW-06	D	Water	SM 4500 NO2 B	
500-29703-7	MW-07	D	Water	SM 4500 NO2 B	
500-29703-8	MW-08	D	Water	SM 4500 NO2 B	
500-29703-9	MW-09	D	Water	SM 4500 NO2 B	
500-29703-10	MW-10	D	Water	SM 4500 NO2 B	
500-29703-11	MW-11	D	Water	SM 4500 NO2 B	
<b>Analysis Batch:500-101531</b>					
LCS 500-101531/2	Lab Control Sample	T	Water	SM 2540C	
MB 500-101531/1	Method Blank	T	Water	SM 2540C	
500-29703-1	MW-01	D	Water	SM 2540C	
500-29703-1DU	Duplicate	D	Water	SM 2540C	
500-29703-1MS	Matrix Spike	D	Water	SM 2540C	
500-29703-2	MW-02	D	Water	SM 2540C	
500-29703-3	MW-03	D	Water	SM 2540C	
500-29703-4	MW-04	D	Water	SM 2540C	
500-29703-5	MW-05	D	Water	SM 2540C	
500-29703-6	MW-06	D	Water	SM 2540C	
500-29703-7	MW-07	D	Water	SM 2540C	
500-29703-8	MW-08	D	Water	SM 2540C	
500-29703-9	MW-09	D	Water	SM 2540C	
500-29703-10	MW-10	D	Water	SM 2540C	
500-29703-11	MW-11	D	Water	SM 2540C	
<b>Analysis Batch:500-101547</b>					
LCS 500-101547/4	Lab Control Sample	T	Water	9038	
MB 500-101547/3	Method Blank	T	Water	9038	
500-29703-1	MW-01	D	Water	9038	
500-29703-2	MW-02	D	Water	9038	
500-29703-3	MW-03	D	Water	9038	

TestAmerica Chicago

## Quality Control Results

Client: Midwest Generation EME LLC

Job Number: 500-29703-1

## QC Association Summary

Lab Sample ID	Client Sample ID	Report Basis	Client Matrix	Method	Prep Batch
<b>General Chemistry</b>					
<b>Prep Batch: 500-101579</b>					
HLCS 500-101579/3-A	High Level Control Sample	T	Water	9010B	
LCS 500-101579/2-A	Lab Control Sample	T	Water	9010B	
LLCS 500-101579/4-A	Low Level Control Sample	T	Water	9010B	
MB 500-101579/1-A	Method Blank	T	Water	9010B	
500-29703-1	MW-01	D	Water	9010B	
500-29703-2	MW-02	D	Water	9010B	
500-29703-3	MW-03	D	Water	9010B	
500-29703-4	MW-04	D	Water	9010B	
500-29703-5	MW-05	D	Water	9010B	
500-29703-6	MW-06	D	Water	9010B	
500-29703-7	MW-07	D	Water	9010B	
500-29703-8	MW-08	D	Water	9010B	
500-29703-9	MW-09	D	Water	9010B	
500-29703-10	MW-10	D	Water	9010B	
500-29703-11	MW-11	D	Water	9010B	
<b>Analysis Batch:500-101622</b>					
HLCS 500-101579/3-A	High Level Control Sample	T	Water	9014	500-101579
LCS 500-101579/2-A	Lab Control Sample	T	Water	9014	500-101579
LLCS 500-101579/4-A	Low Level Control Sample	T	Water	9014	500-101579
MB 500-101579/1-A	Method Blank	T	Water	9014	500-101579
500-29703-1	MW-01	D	Water	9014	500-101579
500-29703-2	MW-02	D	Water	9014	500-101579
500-29703-3	MW-03	D	Water	9014	500-101579
500-29703-4	MW-04	D	Water	9014	500-101579
500-29703-5	MW-05	D	Water	9014	500-101579
500-29703-6	MW-06	D	Water	9014	500-101579
500-29703-7	MW-07	D	Water	9014	500-101579
500-29703-8	MW-08	D	Water	9014	500-101579
500-29703-9	MW-09	D	Water	9014	500-101579
500-29703-10	MW-10	D	Water	9014	500-101579
500-29703-11	MW-11	D	Water	9014	500-101579
<b>Analysis Batch:500-101632</b>					
LCS 500-101632/4	Lab Control Sample	T	Water	9038	
MB 500-101632/3	Method Blank	T	Water	9038	
500-29703-4	MW-04	D	Water	9038	
500-29703-5	MW-05	D	Water	9038	
500-29703-6	MW-06	D	Water	9038	
500-29703-7	MW-07	D	Water	9038	
500-29703-8	MW-08	D	Water	9038	
500-29703-9	MW-09	D	Water	9038	
500-29703-10	MW-10	D	Water	9038	
500-29703-11	MW-11	D	Water	9038	

TestAmerica Chicago

## Quality Control Results

Client: Midwest Generation EME LLC

Job Number: 500-29703-1

## QC Association Summary

Lab Sample ID	Client Sample ID	Report Basis	Client Matrix	Method	Prep Batch
<b>General Chemistry</b>					
<b>Analysis Batch:500-101787</b>					
LCS 500-101787/4	Lab Control Sample	T	Water	SM 4500 F C	
MB 500-101787/3	Method Blank	T	Water	SM 4500 F C	
500-29703-1	MW-01	D	Water	SM 4500 F C	
500-29703-1MS	Matrix Spike	D	Water	SM 4500 F C	
500-29703-1MSD	Matrix Spike Duplicate	D	Water	SM 4500 F C	
500-29703-2	MW-02	D	Water	SM 4500 F C	
500-29703-3	MW-03	D	Water	SM 4500 F C	
500-29703-4	MW-04	D	Water	SM 4500 F C	
500-29703-5	MW-05	D	Water	SM 4500 F C	
500-29703-6	MW-06	D	Water	SM 4500 F C	
500-29703-7	MW-07	D	Water	SM 4500 F C	
500-29703-8	MW-08	D	Water	SM 4500 F C	
500-29703-9	MW-09	D	Water	SM 4500 F C	
500-29703-10	MW-10	D	Water	SM 4500 F C	
500-29703-11	MW-11	D	Water	SM 4500 F C	
<b>Analysis Batch:500-101815</b>					
LCS 500-101815/40	Lab Control Sample	T	Water	9251	
MB 500-101815/39	Method Blank	T	Water	9251	
500-29703-1	MW-01	D	Water	9251	
500-29703-2	MW-02	D	Water	9251	
500-29703-3	MW-03	D	Water	9251	
500-29703-4	MW-04	D	Water	9251	
500-29703-5	MW-05	D	Water	9251	
500-29703-6	MW-06	D	Water	9251	
500-29703-7	MW-07	D	Water	9251	
500-29703-8	MW-08	D	Water	9251	
500-29703-9	MW-09	D	Water	9251	
500-29703-10	MW-10	D	Water	9251	
500-29703-11	MW-11	D	Water	9251	
<b>Analysis Batch:500-101888</b>					
LCS 500-101888/38	Lab Control Sample	T	Water	SM 4500 NO3 F	
MB 500-101888/19	Method Blank	T	Water	SM 4500 NO3 F	
500-29703-1	MW-01	D	Water	SM 4500 NO3 F	
500-29703-2	MW-02	D	Water	SM 4500 NO3 F	
500-29703-6	MW-06	D	Water	SM 4500 NO3 F	
500-29703-7	MW-07	D	Water	SM 4500 NO3 F	
500-29703-8	MW-08	D	Water	SM 4500 NO3 F	
500-29703-9	MW-09	D	Water	SM 4500 NO3 F	
500-29703-9MS	Matrix Spike	D	Water	SM 4500 NO3 F	
500-29703-9MSD	Matrix Spike Duplicate	D	Water	SM 4500 NO3 F	

TestAmerica Chicago

## Quality Control Results

Client: Midwest Generation EME LLC

Job Number: 500-29703-1

## QC Association Summary

Lab Sample ID	Client Sample ID	Report Basis	Client Matrix	Method	Prep Batch
<b>General Chemistry</b>					
<b>Analysis Batch:500-101968</b>					
LCS 500-101968/13	Lab Control Sample	T	Water	SM 4500 NO3 F	
LCS 500-101968/26	Lab Control Sample	T	Water	SM 4500 NO3 F	
MB 500-101968/12	Method Blank	T	Water	SM 4500 NO3 F	
MB 500-101968/25	Method Blank	T	Water	SM 4500 NO3 F	
500-29703-3	MW-03	D	Water	SM 4500 NO3 F	
500-29703-4	MW-04	D	Water	SM 4500 NO3 F	
500-29703-5	MW-05	D	Water	SM 4500 NO3 F	
500-29703-10	MW-10	D	Water	SM 4500 NO3 F	
500-29703-11	MW-11	D	Water	SM 4500 NO3 F	
<b>Analysis Batch:500-101971</b>					
500-29703-1	MW-01	D	Water	Nitrate by calc	
500-29703-2	MW-02	D	Water	Nitrate by calc	
500-29703-3	MW-03	D	Water	Nitrate by calc	
500-29703-4	MW-04	D	Water	Nitrate by calc	
500-29703-5	MW-05	D	Water	Nitrate by calc	
500-29703-6	MW-06	D	Water	Nitrate by calc	
500-29703-7	MW-07	D	Water	Nitrate by calc	
500-29703-8	MW-08	D	Water	Nitrate by calc	
500-29703-9	MW-09	D	Water	Nitrate by calc	
500-29703-10	MW-10	D	Water	Nitrate by calc	
500-29703-11	MW-11	D	Water	Nitrate by calc	

**Report Basis**

D = Dissolved

T = Total

**Quality Control Results**

Client: Midwest Generation EME LLC

Job Number: 500-29703-1

**Method Blank - Batch: 500-101483**

Lab Sample ID: MB 500-101483/1-A  
 Client Matrix: Water  
 Dilution: 1.0  
 Date Analyzed: 12/13/2010 2046  
 Date Prepared: 12/08/2010 1252

Analysis Batch: 500-101835  
 Prep Batch: 500-101483  
 Units: mg/L

**Method: 6020  
 Preparation: Soluble Metals  
 Soluble**

Instrument ID: ICPMS2  
 Lab File ID: MS2121310E.csv  
 Initial Weight/Volume: 1.0 mL  
 Final Weight/Volume: 1.0 mL

Analyte	Result	Qual	RL
Beryllium	<0.0010		0.0010
Boron	<0.050		0.050

**Method Blank - Batch: 500-101483**

Lab Sample ID: MB 500-101483/1-A  
 Client Matrix: Water  
 Dilution: 1.0  
 Date Analyzed: 12/14/2010 1930  
 Date Prepared: 12/08/2010 1252

Analysis Batch: 500-101913  
 Prep Batch: 500-101483  
 Units: mg/L

**Method: 6020  
 Preparation: Soluble Metals  
 Soluble**

Instrument ID: ICPMS2  
 Lab File ID: MS2121410B.csv  
 Initial Weight/Volume: 1.0 mL  
 Final Weight/Volume: 1.0 mL

Analyte	Result	Qual	RL
Arsenic	<0.0010		0.0010
Barium	<0.0025		0.0025
Cadmium	<0.00050		0.00050
Chromium	<0.0050		0.0050
Cobalt	<0.0010		0.0010
Copper	<0.0020		0.0020
Iron	<0.10		0.10
Lead	<0.00050		0.00050
Manganese	<0.0025		0.0025
Nickel	<0.0020		0.0020
Selenium	<0.0025		0.0025
Silver	<0.00050		0.00050
Thallium	<0.0020		0.0020
Zinc	<0.020		0.020



**Quality Control Results**

Client: Midwest Generation EME LLC

Job Number: 500-29703-1

**Method Blank - Batch: 500-101483**

Lab Sample ID: MB 500-101483/1-A  
Client Matrix: Water  
Dilution: 1.0  
Date Analyzed: 12/17/2010 1021  
Date Prepared: 12/08/2010 1252

Analysis Batch: 500-102128  
Prep Batch: 500-101483  
Units: mg/L

**Method: 6020  
Preparation: Soluble Metals  
Soluble**

Instrument ID: ICPMS2  
Lab File ID: MS2121710A.csv  
Initial Weight/Volume: 1.0 mL  
Final Weight/Volume: 1.0 mL

Analyte	Result	Qual	RL
Antimony	<0.0030		0.0030

**Quality Control Results**

Client: Midwest Generation EME LLC

Job Number: 500-29703-1

**Lab Control Sample - Batch: 500-101483**

**Method: 6020**  
**Preparation: Soluble Metals Soluble**

Lab Sample ID: LCS 500-101483/2-A  
 Client Matrix: Water  
 Dilution: 1.0  
 Date Analyzed: 12/13/2010 2047  
 Date Prepared: 12/08/2010 1252

Analysis Batch: 500-101835  
 Prep Batch: 500-101483  
 Units: mg/L

Instrument ID: ICPMS2  
 Lab File ID: MS2121310E.csv  
 Initial Weight/Volume: 1.0 mL  
 Final Weight/Volume: 1.0 mL

Analyte	Spike Amount	Result	% Rec.	Limit	Qual
Beryllium	0.0500	0.0488	98	80 - 120	
Boron	1.00	1.01	101	80 - 120	

**Lab Control Sample - Batch: 500-101483**

**Method: 6020**  
**Preparation: Soluble Metals Soluble**

Lab Sample ID: LCS 500-101483/2-A  
 Client Matrix: Water  
 Dilution: 1.0  
 Date Analyzed: 12/14/2010 1933  
 Date Prepared: 12/08/2010 1252

Analysis Batch: 500-101913  
 Prep Batch: 500-101483  
 Units: mg/L

Instrument ID: ICPMS2  
 Lab File ID: MS2121410B.csv  
 Initial Weight/Volume: 1.0 mL  
 Final Weight/Volume: 1.0 mL

Analyte	Spike Amount	Result	% Rec.	Limit	Qual
Arsenic	0.100	0.0999	100	80 - 120	
Barium	0.500	0.488	98	80 - 120	
Cadmium	0.0500	0.0529	106	80 - 120	
Chromium	0.200	0.204	102	80 - 120	
Cobalt	0.500	0.517	103	80 - 120	
Copper	0.250	0.270	108	80 - 120	
Iron	1.00	0.965	96	80 - 120	
Lead	0.100	0.0997	100	80 - 120	
Manganese	0.500	0.519	104	80 - 120	
Nickel	0.500	0.539	108	80 - 120	
Selenium	0.100	0.104	104	80 - 120	
Silver	0.0500	0.0522	104	80 - 120	
Thallium	0.100	0.103	103	80 - 120	
Zinc	0.500	0.548	110	80 - 120	

**Quality Control Results**

Client: Midwest Generation EME LLC

Job Number: 500-29703-1

**Lab Control Sample - Batch: 500-101483**

**Method: 6020**  
**Preparation: Soluble Metals**  
**Soluble**

Lab Sample ID: LCS 500-101483/2-A  
Client Matrix: Water  
Dilution: 1.0  
Date Analyzed: 12/17/2010 1022  
Date Prepared: 12/08/2010 1252

Analysis Batch: 500-102128  
Prep Batch: 500-101483  
Units: mg/L

Instrument ID: ICPMS2  
Lab File ID: MS2121710A.csv  
Initial Weight/Volume: 1.0 mL  
Final Weight/Volume: 1.0 mL

Analyte	Spike Amount	Result	% Rec.	Limit	Qual
Antimony	0.500	0.432	86	80 - 120	

**Quality Control Results**

Client: Midwest Generation EME LLC

Job Number: 500-29703-1

**Matrix Spike/  
Matrix Spike Duplicate Recovery Report - Batch: 500-101483**

**Method: 6020  
Preparation: Soluble Metals  
Dissolved**

MS Lab Sample ID: 500-29703-1  
Client Matrix: Water  
Dilution: 1.0  
Date Analyzed: 12/13/2010 2054  
Date Prepared: 12/08/2010 1252

Analysis Batch: 500-101835  
Prep Batch: 500-101483

Instrument ID: ICPMS2  
Lab File ID: MS2121310E.csv  
Initial Weight/Volume: 1.0 mL  
Final Weight/Volume: 1.0 mL

MSD Lab Sample ID: 500-29703-1  
Client Matrix: Water  
Dilution: 1.0  
Date Analyzed: 12/13/2010 2055  
Date Prepared: 12/08/2010 1252

Analysis Batch: 500-101835  
Prep Batch: 500-101483

Instrument ID: ICPMS2  
Lab File ID: MS2121310E.csv  
Initial Weight/Volume: 1.0 mL  
Final Weight/Volume: 1.0 mL

Analyte	% Rec.		Limit	RPD	RPD Limit	MS Qual	MSD Qual
	MS	MSD					
Beryllium	95	95	75 - 125	0	20		
Boron	98	99	75 - 125	1	20		

**Quality Control Results**

Client: Midwest Generation EME LLC

Job Number: 500-29703-1

**Matrix Spike/  
Matrix Spike Duplicate Recovery Report - Batch: 500-101483**

**Method: 6020  
Preparation: Soluble Metals  
Dissolved**

MS Lab Sample ID: 500-29703-1  
Client Matrix: Water  
Dilution: 1.0  
Date Analyzed: 12/14/2010 1944  
Date Prepared: 12/08/2010 1252

Analysis Batch: 500-101913  
Prep Batch: 500-101483

Instrument ID: ICPMS2  
Lab File ID: MS2121410B.csv  
Initial Weight/Volume: 1.0 mL  
Final Weight/Volume: 1.0 mL

MSD Lab Sample ID: 500-29703-1  
Client Matrix: Water  
Dilution: 1.0  
Date Analyzed: 12/14/2010 1946  
Date Prepared: 12/08/2010 1252

Analysis Batch: 500-101913  
Prep Batch: 500-101483

Instrument ID: ICPMS2  
Lab File ID: MS2121410B.csv  
Initial Weight/Volume: 1.0 mL  
Final Weight/Volume: 1.0 mL

Analyte	% Rec.		Limit	RPD	RPD Limit	MS Qual	MSD Qual
	MS	MSD					
Arsenic	107	111	75 - 125	3	20		
Barium	94	96	75 - 125	2	20		
Cadmium	102	103	75 - 125	1	20		
Chromium	95	101	75 - 125	6	20		
Cobalt	95	100	75 - 125	6	20		
Copper	96	103	75 - 125	6	20		
Iron	90	98	75 - 125	9	20		
Lead	98	99	75 - 125	1	20		
Manganese	98	104	75 - 125	6	20		
Nickel	97	103	75 - 125	7	20		
Selenium	121	126	75 - 125	5	20		F
Silver	64	62	75 - 125	2	20	F	F
Thallium	102	103	75 - 125	1	20		
Zinc	105	113	75 - 125	7	20		

**Quality Control Results**

Client: Midwest Generation EME LLC

Job Number: 500-29703-1

**Matrix Spike/  
Matrix Spike Duplicate Recovery Report - Batch: 500-101483**

**Method: 6020  
Preparation: Soluble Metals  
Dissolved**

MS Lab Sample ID: 500-29703-1  
Client Matrix: Water  
Dilution: 1.0  
Date Analyzed: 12/17/2010 1026  
Date Prepared: 12/08/2010 1252

Analysis Batch: 500-102128  
Prep Batch: 500-101483

Instrument ID: ICPMS2  
Lab File ID: MS2121710A.csv  
Initial Weight/Volume: 1.0 mL  
Final Weight/Volume: 1.0 mL

MSD Lab Sample ID: 500-29703-1  
Client Matrix: Water  
Dilution: 1.0  
Date Analyzed: 12/17/2010 1027  
Date Prepared: 12/08/2010 1252

Analysis Batch: 500-102128  
Prep Batch: 500-101483

Instrument ID: ICPMS2  
Lab File ID: MS2121710A.csv  
Initial Weight/Volume: 1.0 mL  
Final Weight/Volume: 1.0 mL

Analyte	% Rec.		Limit	RPD	RPD Limit	MS Qual	MSD Qual
	MS	MSD					
Antimony	87	91	75 - 125	4	20		

**Quality Control Results**

Client: Midwest Generation EME LLC

Job Number: 500-29703-1

**Duplicate - Batch: 500-101483**

**Method: 6020**  
**Preparation: Soluble Metals Dissolved**

Lab Sample ID: 500-29703-1  
Client Matrix: Water  
Dilution: 1.0  
Date Analyzed: 12/13/2010 2053  
Date Prepared: 12/08/2010 1252

Analysis Batch: 500-101835  
Prep Batch: 500-101483  
Units: mg/L

Instrument ID: ICPMS2  
Lab File ID: MS2121310E.csv  
Initial Weight/Volume: 1.0 mL  
Final Weight/Volume: 1.0 mL

Analyte	Sample Result/Qual	Result	RPD	Limit	Qual
Beryllium	<0.0010	<0.0010	NC	20	
Boron	0.31	0.307	0.7	20	

**Duplicate - Batch: 500-101483**

**Method: 6020**  
**Preparation: Soluble Metals Dissolved**

Lab Sample ID: 500-29703-1  
Client Matrix: Water  
Dilution: 1.0  
Date Analyzed: 12/14/2010 1941  
Date Prepared: 12/08/2010 1252

Analysis Batch: 500-101913  
Prep Batch: 500-101483  
Units: mg/L

Instrument ID: ICPMS2  
Lab File ID: MS2121410B.csv  
Initial Weight/Volume: 1.0 mL  
Final Weight/Volume: 1.0 mL

Analyte	Sample Result/Qual	Result	RPD	Limit	Qual
Arsenic	0.0011	<0.0010	NC	20	
Barium	0.13	0.130	2	20	
Cadmium	<0.00050	<0.00050	NC	20	
Chromium	<0.0050	<0.0050	NC	20	
Cobalt	<0.0010	<0.0010	NC	20	
Copper	0.0032	0.00325	2	20	
Iron	<0.10	<0.10	NC	20	
Lead	<0.00050	<0.00050	NC	20	
Manganese	<0.0025	<0.0025	NC	20	
Nickel	0.0034	0.00317	7	20	
Selenium	<0.0025	<0.0025	NC	20	
Silver	<0.00050	<0.00050	NC	20	
Thallium	<0.0020	<0.0020	NC	20	
Zinc	<0.020	<0.020	NC	20	



**Quality Control Results**

Client: Midwest Generation EME LLC

Job Number: 500-29703-1

**Duplicate - Batch: 500-101483**

Lab Sample ID: 500-29703-1  
Client Matrix: Water  
Dilution: 1.0  
Date Analyzed: 12/17/2010 1025  
Date Prepared: 12/08/2010 1252

Analysis Batch: 500-102128  
Prep Batch: 500-101483  
Units: mg/L

**Method: 6020  
Preparation: Soluble Metals  
Dissolved**

Instrument ID: ICPMS2  
Lab File ID: MS2121710A.csv  
Initial Weight/Volume: 1.0 mL  
Final Weight/Volume: 1.0 mL

Analyte	Sample Result/Qual	Result	RPD	Limit	Qual
Antimony	0.0043	<0.0030	NC	20	

**Quality Control Results**

Client: Midwest Generation EME LLC

Job Number: 500-29703-1

**Method Blank - Batch: 500-101452**

Lab Sample ID: MB 500-101452/7-A  
 Client Matrix: Water  
 Dilution: 1.0  
 Date Analyzed: 12/08/2010 1248  
 Date Prepared: 12/08/2010 0920

Analysis Batch: 500-101510  
 Prep Batch: 500-101452  
 Units: mg/L

**Method: 7470A  
 Preparation: 7470A**

Instrument ID: HG6  
 Lab File ID: 120810R.CSV  
 Initial Weight/Volume: 25 mL  
 Final Weight/Volume: 25 mL

Analyte	Result	Qual	RL
Mercury	<0.00020		0.00020

**Lab Control Sample - Batch: 500-101452**

Lab Sample ID: LCS 500-101452/8-A  
 Client Matrix: Water  
 Dilution: 1.0  
 Date Analyzed: 12/08/2010 1250  
 Date Prepared: 12/08/2010 0920

Analysis Batch: 500-101510  
 Prep Batch: 500-101452  
 Units: mg/L

**Method: 7470A  
 Preparation: 7470A**

Instrument ID: HG6  
 Lab File ID: 120810R.CSV  
 Initial Weight/Volume: 25 mL  
 Final Weight/Volume: 25 mL

Analyte	Spike Amount	Result	% Rec.	Limit	Qual
Mercury	0.00200	0.00203	101	80 - 120	

**Matrix Spike/  
 Matrix Spike Duplicate Recovery Report - Batch: 500-101452**

MS Lab Sample ID: 500-29703-1  
 Client Matrix: Water  
 Dilution: 1.0  
 Date Analyzed: 12/08/2010 1308  
 Date Prepared: 12/08/2010 0920

Analysis Batch: 500-101510  
 Prep Batch: 500-101452

**Method: 7470A  
 Preparation: 7470A  
 Dissolved**

Instrument ID: HG6  
 Lab File ID: 120810R.CSV  
 Initial Weight/Volume: 25 mL  
 Final Weight/Volume: 25 mL

MSD Lab Sample ID: 500-29703-1  
 Client Matrix: Water  
 Dilution: 1.0  
 Date Analyzed: 12/08/2010 1310  
 Date Prepared: 12/08/2010 0920

Analysis Batch: 500-101510  
 Prep Batch: 500-101452

Instrument ID: HG6  
 Lab File ID: 120810R.CSV  
 Initial Weight/Volume: 25 mL  
 Final Weight/Volume: 25 mL

Analyte	% Rec.		Limit	RPD	RPD Limit	MS Qual	MSD Qual
	MS	MSD					
Mercury	125	116	75 - 125	7	20		

**Quality Control Results**

Client: Midwest Generation EME LLC

Job Number: 500-29703-1

**Duplicate - Batch: 500-101452**

Lab Sample ID: 500-29703-1  
Client Matrix: Water  
Dilution: 1.0  
Date Analyzed: 12/08/2010 1306  
Date Prepared: 12/08/2010 0920

Analysis Batch: 500-101510  
Prep Batch: 500-101452  
Units: mg/L

**Method: 7470A**  
**Preparation: 7470A**  
**Dissolved**  
Instrument ID: HG6  
Lab File ID: 120810R.CSV  
Initial Weight/Volume: 25 mL  
Final Weight/Volume: 25 mL

Analyte	Sample Result/Qual	Result	RPD	Limit	Qual
Mercury	<0.00020	<0.00020	NC	20	

**Quality Control Results**

Client: Midwest Generation EME LLC

Job Number: 500-29703-1

**Method Blank - Batch: 500-101579**

**Method: 9014**  
**Preparation: 9010B**

Lab Sample ID: MB 500-101579/1-A  
Client Matrix: Water  
Dilution: 1.0  
Date Analyzed: 12/09/2010 1605  
Date Prepared: 12/09/2010 1250

Analysis Batch: 500-101622  
Prep Batch: 500-101579  
Units: mg/L

Instrument ID: SPEC5  
Lab File ID: N/A  
Initial Weight/Volume: 50 mL  
Final Weight/Volume: 50 mL

Analyte	Result	Qual	RL
Cyanide, Total-Dissolved	<0.010		0.010

**Quality Control Results**

Client: Midwest Generation EME LLC

Job Number: 500-29703-1

**Lab Control Sample - Batch: 500-101579**

**Method: 9014**  
**Preparation: 9010B**

Lab Sample ID: LCS 500-101579/2-A  
Client Matrix: Water  
Dilution: 1.0  
Date Analyzed: 12/09/2010 1605  
Date Prepared: 12/09/2010 1250

Analysis Batch: 500-101622  
Prep Batch: 500-101579  
Units: mg/L

Instrument ID: SPEC5  
Lab File ID: N/A  
Initial Weight/Volume: 50 mL  
Final Weight/Volume: 50 mL

Analyte	Spike Amount	Result	% Rec.	Limit	Qual
Cyanide, Total-Dissolved	0.100	0.105	105	80 - 120	

**High Level Control Sample - Batch: 500-101579**

**Method: 9014**  
**Preparation: 9010B**

Lab Sample ID: HLCS 500-101579/3-A  
Client Matrix: Water  
Dilution: 1.0  
Date Analyzed: 12/09/2010 1606  
Date Prepared: 12/09/2010 1250

Analysis Batch: 500-101622  
Prep Batch: 500-101579  
Units: mg/L

Instrument ID: SPEC5  
Lab File ID: N/A  
Initial Weight/Volume: 50 mL  
Final Weight/Volume: 50 mL

Analyte	Spike Amount	Result	% Rec.	Limit	Qual
Cyanide, Total-Dissolved	0.400	0.405	101	90 - 110	

**Low Level Control Sample - Batch: 500-101579**

**Method: 9014**  
**Preparation: 9010B**

Lab Sample ID: LLCS 500-101579/4-A  
Client Matrix: Water  
Dilution: 1.0  
Date Analyzed: 12/09/2010 1606  
Date Prepared: 12/09/2010 1250

Analysis Batch: 500-101622  
Prep Batch: 500-101579  
Units: mg/L

Instrument ID: SPEC5  
Lab File ID: N/A  
Initial Weight/Volume: 50 mL  
Final Weight/Volume: 50 mL

Analyte	Spike Amount	Result	% Rec.	Limit	Qual
Cyanide, Total-Dissolved	0.0400	0.0437	109	75 - 125	

**Quality Control Results**

Client: Midwest Generation EME LLC

Job Number: 500-29703-1

**Method Blank - Batch: 500-101547**

Lab Sample ID: MB 500-101547/3  
 Client Matrix: Water  
 Dilution: 1.0  
 Date Analyzed: 12/09/2010 0550  
 Date Prepared: N/A

Analysis Batch: 500-101547  
 Prep Batch: N/A  
 Units: mg/L

**Method: 9038  
 Preparation: N/A**

Instrument ID: SPEC3  
 Lab File ID: N/A  
 Initial Weight/Volume: 1.0 mL  
 Final Weight/Volume: 1.0 mL

Analyte	Result	Qual	RL
Sulfate-Dissolved	<5.0		5.0

**Lab Control Sample - Batch: 500-101547**

Lab Sample ID: LCS 500-101547/4  
 Client Matrix: Water  
 Dilution: 1.0  
 Date Analyzed: 12/09/2010 0551  
 Date Prepared: N/A

Analysis Batch: 500-101547  
 Prep Batch: N/A  
 Units: mg/L

**Method: 9038  
 Preparation: N/A**

Instrument ID: SPEC3  
 Lab File ID: N/A  
 Initial Weight/Volume: 100 mL  
 Final Weight/Volume: 100 mL

Analyte	Spike Amount	Result	% Rec.	Limit	Qual
Sulfate-Dissolved	20.0	18.4	92	80 - 120	

**Quality Control Results**

Client: Midwest Generation EME LLC

Job Number: 500-29703-1

**Method Blank - Batch: 500-101632**

Lab Sample ID: MB 500-101632/3  
 Client Matrix: Water  
 Dilution: 1.0  
 Date Analyzed: 12/09/2010 0654  
 Date Prepared: N/A

Analysis Batch: 500-101632  
 Prep Batch: N/A  
 Units: mg/L

**Method: 9038**  
**Preparation: N/A**

Instrument ID: SPEC3  
 Lab File ID: N/A  
 Initial Weight/Volume: 1.0 mL  
 Final Weight/Volume: 1.0 mL

Analyte	Result	Qual	RL
Sulfate-Dissolved	<5.0		5.0

**Lab Control Sample - Batch: 500-101632**

Lab Sample ID: LCS 500-101632/4  
 Client Matrix: Water  
 Dilution: 1.0  
 Date Analyzed: 12/09/2010 0655  
 Date Prepared: N/A

Analysis Batch: 500-101632  
 Prep Batch: N/A  
 Units: mg/L

**Method: 9038**  
**Preparation: N/A**

Instrument ID: SPEC3  
 Lab File ID: N/A  
 Initial Weight/Volume: 100 mL  
 Final Weight/Volume: 100 mL

Analyte	Spike Amount	Result	% Rec.	Limit	Qual
Sulfate-Dissolved	20.0	19.6	98	80 - 120	



**Quality Control Results**

Client: Midwest Generation EME LLC

Job Number: 500-29703-1

**Method Blank - Batch: 500-101815**

**Method: 9251  
Preparation: N/A**

Lab Sample ID: MB 500-101815/39  
Client Matrix: Water  
Dilution: 1.0  
Date Analyzed: 12/13/2010 1654  
Date Prepared: N/A

Analysis Batch: 500-101815  
Prep Batch: N/A  
Units: mg/L

Instrument ID: AQ2  
Lab File ID: 2010-12-13-17-30-12.csv  
Initial Weight/Volume: 1.0 mL  
Final Weight/Volume: 1.0 mL

Analyte	Result	Qual	RL
Chloride-Dissolved	<2.0		2.0

**Lab Control Sample - Batch: 500-101815**

**Method: 9251  
Preparation: N/A**

Lab Sample ID: LCS 500-101815/40  
Client Matrix: Water  
Dilution: 1.0  
Date Analyzed: 12/13/2010 1655  
Date Prepared: N/A

Analysis Batch: 500-101815  
Prep Batch: N/A  
Units: mg/L

Instrument ID: AQ2  
Lab File ID: 2010-12-13-17-30-12.csv  
Initial Weight/Volume: 50 mL  
Final Weight/Volume: 50 mL

Analyte	Spike Amount	Result	% Rec.	Limit	Qual
Chloride-Dissolved	50.0	52.1	104	80 - 120	

**Quality Control Results**

Client: Midwest Generation EME LLC

Job Number: 500-29703-1

**Method Blank - Batch: 500-101531**

**Method: SM 2540C**  
**Preparation: N/A**

Lab Sample ID: MB 500-101531/1  
Client Matrix: Water  
Dilution: 1.0  
Date Analyzed: 12/08/2010 2321  
Date Prepared: N/A

Analysis Batch: 500-101531  
Prep Batch: N/A  
Units: mg/L

Instrument ID: No Equipment Assigned  
Lab File ID: N/A  
Initial Weight/Volume: 50 mL  
Final Weight/Volume: 50 mL

Analyte	Result	Qual	RL
Total Dissolved Solids-Dissolved	<10		10

**Lab Control Sample - Batch: 500-101531**

**Method: SM 2540C**  
**Preparation: N/A**

Lab Sample ID: LCS 500-101531/2  
Client Matrix: Water  
Dilution: 1.0  
Date Analyzed: 12/08/2010 2323  
Date Prepared: N/A

Analysis Batch: 500-101531  
Prep Batch: N/A  
Units: mg/L

Instrument ID: No Equipment Assigned  
Lab File ID: N/A  
Initial Weight/Volume: 50 mL  
Final Weight/Volume: 50 mL

Analyte	Spike Amount	Result	% Rec.	Limit	Qual
Total Dissolved Solids-Dissolved	250	260	104	80 - 120	

**Matrix Spike - Batch: 500-101531**

**Method: SM 2540C**  
**Preparation: N/A**

Lab Sample ID: 500-29703-1  
Client Matrix: Water  
Dilution: 1.0  
Date Analyzed: 12/08/2010 2333  
Date Prepared: N/A

Analysis Batch: 500-101531  
Prep Batch: N/A  
Units: mg/L

Instrument ID: No Equipment Assigned  
Lab File ID: N/A  
Initial Weight/Volume: 50 mL  
Final Weight/Volume: 50 mL

Analyte	Sample Result/Qual	Spike Amount	Result	% Rec.	Limit	Qual
Total Dissolved Solids-Dissolved	590	250	854	105	75 - 125	

**Quality Control Results**

Client: Midwest Generation EME LLC

Job Number: 500-29703-1

**Duplicate - Batch: 500-101531**

**Method: SM 2540C**  
**Preparation: N/A**

Lab Sample ID: 500-29703-1  
Client Matrix: Water  
Dilution: 1.0  
Date Analyzed: 12/08/2010 2331  
Date Prepared: N/A

Analysis Batch: 500-101531  
Prep Batch: N/A  
Units: mg/L

Instrument ID: No Equipment Assigned  
Lab File ID: N/A  
Initial Weight/Volume: 50 mL  
Final Weight/Volume: 50 mL

Analyte	Sample Result/Qual	Result	RPD	Limit	Qual
Total Dissolved Solids-Dissolved	590	598	1	20	

**Quality Control Results**

Client: Midwest Generation EME LLC

Job Number: 500-29703-1

**Method Blank - Batch: 500-101787**

**Method: SM 4500 F C  
Preparation: N/A**

Lab Sample ID: MB 500-101787/3  
Client Matrix: Water  
Dilution: 1.0  
Date Analyzed: 12/13/2010 1131  
Date Prepared: N/A

Analysis Batch: 500-101787  
Prep Batch: N/A  
Units: mg/L

Instrument ID: PC-Titrate  
Lab File ID: 10121300.txt  
Initial Weight/Volume: 1.0 mL  
Final Weight/Volume: 1.0 mL

Analyte	Result	Qual	RL
Fluoride-Dissolved	<0.10		0.10

**Lab Control Sample - Batch: 500-101787**

**Method: SM 4500 F C  
Preparation: N/A**

Lab Sample ID: LCS 500-101787/4  
Client Matrix: Water  
Dilution: 1.0  
Date Analyzed: 12/13/2010 1134  
Date Prepared: N/A

Analysis Batch: 500-101787  
Prep Batch: N/A  
Units: mg/L

Instrument ID: PC-Titrate  
Lab File ID: 10121300.txt  
Initial Weight/Volume: 100 mL  
Final Weight/Volume: 100 mL

Analyte	Spike Amount	Result	% Rec.	Limit	Qual
Fluoride-Dissolved	10.0	10.3	103	80 - 120	

**Matrix Spike/  
Matrix Spike Duplicate Recovery Report - Batch: 500-101787**

**Method: SM 4500 F C  
Preparation: N/A**

MS Lab Sample ID: 500-29703-1  
Client Matrix: Water  
Dilution: 1.0  
Date Analyzed: 12/13/2010 1221  
Date Prepared: N/A

Analysis Batch: 500-101787  
Prep Batch: N/A

Instrument ID: PC-Titrate  
Lab File ID: 10121300.txt  
Initial Weight/Volume: 100 mL  
Final Weight/Volume: 100 mL

MSD Lab Sample ID: 500-29703-1  
Client Matrix: Water  
Dilution: 1.0  
Date Analyzed: 12/13/2010 1224  
Date Prepared: N/A

Analysis Batch: 500-101787  
Prep Batch: N/A

Instrument ID: PC-Titrate  
Lab File ID: 10121300.txt  
Initial Weight/Volume: 100 mL  
Final Weight/Volume: 100 mL

Analyte	% Rec.		Limit	RPD	RPD Limit	MS Qual	MSD Qual
	MS	MSD					
Fluoride-Dissolved	107	105	75 - 125	1	20		

**Quality Control Results**

Client: Midwest Generation EME LLC

Job Number: 500-29703-1

**Method Blank - Batch: 500-101499**

**Method: SM 4500 NO2 B  
Preparation: N/A**

Lab Sample ID: MB 500-101499/3  
Client Matrix: Water  
Dilution: 1.0  
Date Analyzed: 12/08/2010 1040  
Date Prepared: N/A

Analysis Batch: 500-101499  
Prep Batch: N/A  
Units: mg/L

Instrument ID: SPEC5  
Lab File ID: N/A  
Initial Weight/Volume: 50 mL  
Final Weight/Volume: 50 mL

Analyte	Result	Qual	RL
Nitrogen, Nitrite-Dissolved	<0.020		0.020

**Lab Control Sample - Batch: 500-101499**

**Method: SM 4500 NO2 B  
Preparation: N/A**

Lab Sample ID: LCS 500-101499/4  
Client Matrix: Water  
Dilution: 1.0  
Date Analyzed: 12/08/2010 1041  
Date Prepared: N/A

Analysis Batch: 500-101499  
Prep Batch: N/A  
Units: mg/L

Instrument ID: SPEC5  
Lab File ID: N/A  
Initial Weight/Volume: 50 mL  
Final Weight/Volume: 50 mL

Analyte	Spike Amount	Result	% Rec.	Limit	Qual
Nitrogen, Nitrite-Dissolved	0.100	0.0995	100	80 - 120	

**Matrix Spike/  
Matrix Spike Duplicate Recovery Report - Batch: 500-101499**

**Method: SM 4500 NO2 B  
Preparation: N/A**

MS Lab Sample ID: 500-29703-1  
Client Matrix: Water  
Dilution: 1.0  
Date Analyzed: 12/08/2010 1043  
Date Prepared: N/A

Analysis Batch: 500-101499  
Prep Batch: N/A

Instrument ID: SPEC5  
Lab File ID: N/A  
Initial Weight/Volume: 50 mL  
Final Weight/Volume: 50 mL

MSD Lab Sample ID: 500-29703-1  
Client Matrix: Water  
Dilution: 1.0  
Date Analyzed: 12/08/2010 1044  
Date Prepared: N/A

Analysis Batch: 500-101499  
Prep Batch: N/A

Instrument ID: SPEC5  
Lab File ID: N/A  
Initial Weight/Volume: 50 mL  
Final Weight/Volume: 50 mL

Analyte	% Rec.		Limit	RPD	RPD Limit	MS Qual	MSD Qual
	MS	MSD					
Nitrogen, Nitrite-Dissolved	93	94	75 - 125	1	20		

**Quality Control Results**

Client: Midwest Generation EME LLC

Job Number: 500-29703-1

**Method Blank - Batch: 500-101888**

**Method: SM 4500 NO3 F  
Preparation: N/A**

Lab Sample ID: MB 500-101888/19  
Client Matrix: Water  
Dilution: 1.0  
Date Analyzed: 12/14/2010 1515  
Date Prepared: N/A

Analysis Batch: 500-101888  
Prep Batch: N/A  
Units: mg/L

Instrument ID: AQ2  
Lab File ID: 2010-12-14-16-16-11.csv  
Initial Weight/Volume: 1.0 mL  
Final Weight/Volume: 1.0 mL

Analyte	Result	Qual	RL
Nitrogen, Nitrate Nitrite-Dissolved	<0.10	^	0.10

**Lab Control Sample - Batch: 500-101888**

**Method: SM 4500 NO3 F  
Preparation: N/A**

Lab Sample ID: LCS 500-101888/38  
Client Matrix: Water  
Dilution: 1.0  
Date Analyzed: 12/14/2010 1606  
Date Prepared: N/A

Analysis Batch: 500-101888  
Prep Batch: N/A  
Units: mg/L

Instrument ID: AQ2  
Lab File ID: 2010-12-14-16-16-11.csv  
Initial Weight/Volume: 100 mL  
Final Weight/Volume: 100 mL

Analyte	Spike Amount	Result	% Rec.	Limit	Qual
Nitrogen, Nitrate Nitrite-Dissolved	1.00	1.08	108	80 - 120	

**Matrix Spike/  
Matrix Spike Duplicate Recovery Report - Batch: 500-101888**

**Method: SM 4500 NO3 F  
Preparation: N/A**

MS Lab Sample ID: 500-29703-9  
Client Matrix: Water  
Dilution: 1.0  
Date Analyzed: 12/14/2010 1613  
Date Prepared: N/A

Analysis Batch: 500-101888  
Prep Batch: N/A

Instrument ID: AQ2  
Lab File ID: 2010-12-14-16-16-11.csv  
Initial Weight/Volume: 10 mL  
Final Weight/Volume: 10 mL

MSD Lab Sample ID: 500-29703-9  
Client Matrix: Water  
Dilution: 1.0  
Date Analyzed: 12/14/2010 1614  
Date Prepared: N/A

Analysis Batch: 500-101888  
Prep Batch: N/A

Instrument ID: AQ2  
Lab File ID: 2010-12-14-16-16-11.csv  
Initial Weight/Volume: 10 mL  
Final Weight/Volume: 10 mL

Analyte	% Rec.		Limit	RPD	RPD Limit	MS Qual	MSD Qual
	MS	MSD					
Nitrogen, Nitrate Nitrite-Dissolved	91	97	75 - 125	5	20		

**Quality Control Results**

Client: Midwest Generation EME LLC

Job Number: 500-29703-1

**Method Blank - Batch: 500-101968**

**Method: SM 4500 NO3 F  
Preparation: N/A**

Lab Sample ID: MB 500-101968/12  
Client Matrix: Water  
Dilution: 1.0  
Date Analyzed: 12/15/2010 1433  
Date Prepared: N/A

Analysis Batch: 500-101968  
Prep Batch: N/A  
Units: mg/L

Instrument ID: AQ2  
Lab File ID: 20101215.csv  
Initial Weight/Volume: 1.0 mL  
Final Weight/Volume: 1.0 mL

Analyte	Result	Qual	RL
Nitrogen, Nitrate Nitrite-Dissolved	<0.10		0.10

**Method Blank - Batch: 500-101968**

**Method: SM 4500 NO3 F  
Preparation: N/A**

Lab Sample ID: MB 500-101968/25  
Client Matrix: Water  
Dilution: 1.0  
Date Analyzed: 12/15/2010 1501  
Date Prepared: N/A

Analysis Batch: 500-101968  
Prep Batch: N/A  
Units: mg/L

Instrument ID: AQ2  
Lab File ID: 20101215.csv  
Initial Weight/Volume: 1.0 mL  
Final Weight/Volume: 1.0 mL

Analyte	Result	Qual	RL
Nitrogen, Nitrate Nitrite-Dissolved	<0.10		0.10



**Quality Control Results**

Client: Midwest Generation EME LLC

Job Number: 500-29703-1

**Lab Control Sample - Batch: 500-101968**

**Method: SM 4500 NO3 F  
Preparation: N/A**

Lab Sample ID: LCS 500-101968/13  
Client Matrix: Water  
Dilution: 1.0  
Date Analyzed: 12/15/2010 1435  
Date Prepared: N/A

Analysis Batch: 500-101968  
Prep Batch: N/A  
Units: mg/L

Instrument ID: AQ2  
Lab File ID: 20101215.csv  
Initial Weight/Volume: 100 mL  
Final Weight/Volume: 100 mL

Analyte	Spike Amount	Result	% Rec.	Limit	Qual
Nitrogen, Nitrate Nitrite-Dissolved	1.00	1.15	115	80 - 120	

**Lab Control Sample - Batch: 500-101968**

**Method: SM 4500 NO3 F  
Preparation: N/A**

Lab Sample ID: LCS 500-101968/26  
Client Matrix: Water  
Dilution: 1.0  
Date Analyzed: 12/15/2010 1503  
Date Prepared: N/A

Analysis Batch: 500-101968  
Prep Batch: N/A  
Units: mg/L

Instrument ID: AQ2  
Lab File ID: 20101215.csv  
Initial Weight/Volume: 100 mL  
Final Weight/Volume: 100 mL

Analyte	Spike Amount	Result	% Rec.	Limit	Qual
Nitrogen, Nitrate Nitrite-Dissolved	1.00	1.14	114	80 - 120	

# TestAmerica

THE LEADER IN ENVIRONMENTAL TESTING

2417 Bond Street, University Park, IL 60484  
Phone: 708.534.5200 Fax: 708.534.5211

Electronic Filing: Received Clerk's Office 3/24/2022

Report To: Andrew Gaydon Bill To: \_\_\_\_\_  
 Contact: Andrew Gaydon Company: \_\_\_\_\_  
 Company: Patrick Eng. Address: \_\_\_\_\_  
 Address: 4985 Varsity Drive Address: \_\_\_\_\_  
 Address: Little IL 60532 Address: \_\_\_\_\_  
 Phone: 630-725-7359 Phone: \_\_\_\_\_  
 Fax: 630-724-9290 Fax: \_\_\_\_\_  
 E-Mail: AGAYDON@PatrickEng.com PO#/Reference# \_\_\_\_\_

## Chain of Custody Record

Lab Job #: 500-29703  
 Chain of Custody Number: \_\_\_\_\_  
 Page \_\_\_\_\_ of \_\_\_\_\_  
 Temperature °C of Cooler: (3.4)(2.9)

Client		Client Project #		Preservative		Parameter		Comments				
<u>Patrick Engineering</u>		<u>21053.070</u>						Preservative Key 1. HCL, Cool to 4° 2. H2SO4, Cool to 4° 3. HNO3, Cool to 4° 4. NaOH, Cool to 4° 5. NaOH/Zn, Cool to 4° 6. NaHSO4 7. Cool to 4° 8. None 9. Other				
Project Name		Lab Project #		Parameter		Parameter		Comments				
<u>Midwest Gen. Ash pond</u>												
Project Location/State		Lab PM		Parameter		Parameter		Comments				
<u>Solict, IL</u>												
Sampler		Lab PM		Parameter		Parameter		Comments				
<u>DM</u>												
Lat ID	MS/MSD	Sample ID	Sampling		# of Containers	Matrix	Disinfectant NO3- NO2	Disinfectant TDS, F, SO4, Cl	Disinfectant cyanide	Nitric Acid	Dissolved NO2	Comments
			Date	Time								
1		MW-01	12/6/10	14:25	5	W	X	X	X	X	X	
2		MW-02	12/6/10	13:45								
3		MW-03	12/2/10	10:10								
4		MW-04	12/2/10	11:00								
5		MW-05	12/2/10	11:45								
6		MW-06	ret	9:30								
7		MW-07	12/2/10	8:55								
8		MW-08	12/6/10	14:55								
9		MW-09	12/6/10	11:15								
10		MW-10	12/6/10	15:20								
11		MW-11	12/6/10	16:00								

Turnaround Time Required (Business Days):  
 \_\_\_ 1 Day \_\_\_ 2 Days \_\_\_ 5 Days \_\_\_ 7 Days \_\_\_ 10 Days  15 Days \_\_\_ Other  
 Requested Due Date: \_\_\_\_\_

Sample Disposal:  
 Return to Client  Disposal by Lab  Archive for \_\_\_\_\_ Months (A fee may be assessed if samples are retained longer than 1 month)

Relinquished By: <u>[Signature]</u>	Company: <u>Patrick Eng.</u>	Date: <u>12/2/10</u>	Time: <u>1250</u>	Received By: <u>[Signature]</u>	Company: <u>TestAmerica</u>	Date: <u>12/7/10</u>	Time: <u>1250</u>	Lab Courier: _____
Relinquished By: _____	Company: _____	Date: _____	Time: _____	Received By: _____	Company: _____	Date: _____	Time: _____	Shipped: _____
Relinquished By: _____	Company: _____	Date: _____	Time: _____	Received By: _____	Company: _____	Date: _____	Time: _____	Hand Delivered: _____

Matrix Key:  
 WW - Wastewater SE - Sediment  
 W - Water SO - Soil  
 S - Soil L - Leachate  
 SL - Sludge WI - Wipe  
 MS - Miscellaneous DW - Drinking Water  
 OL - Oil O - Other  
 A - Air

Client Comments: \_\_\_\_\_

Lab Comments: \_\_\_\_\_

## Login Sample Receipt Check List

Client: Midwest Generation EME LLC

Job Number: 500-29703-1

Login Number: 29703

List Source: TestAmerica Chicago

Creator: Kelsey, Shawn M

List Number: 1

Question	T / F / NA	Comment
Radioactivity either was not measured or, if measured, is at or below background	True	
The cooler's custody seal, if present, is intact.	True	
The cooler or samples do not appear to have been compromised or tampered with.	True	
Samples were received on ice.	True	
Cooler Temperature is acceptable.	True	
Cooler Temperature is recorded.	True	
COC is present.	True	
COC is filled out in ink and legible.	True	
COC is filled out with all pertinent information.	True	
Is the Field Sampler's name present on COC?	True	
There are no discrepancies between the sample IDs on the containers and the COC.	True	
Samples are received within Holding Time.	True	
Sample containers have legible labels.	True	
Containers are not broken or leaking.	True	
Sample collection date/times are provided.	True	
Appropriate sample containers are used.	True	
Sample bottles are completely filled.	True	
Sample Preservation Verified	True	
There is sufficient vol. for all requested analyses, incl. any requested MS/MSDs	True	
VOA sample vials do not have headspace or bubble is <6mm (1/4") in diameter.	N/A	
If necessary, staff have been informed of any short hold time or quick TAT needs	True	
Multiphasic samples are not present.	True	
Samples do not require splitting or compositing.	True	

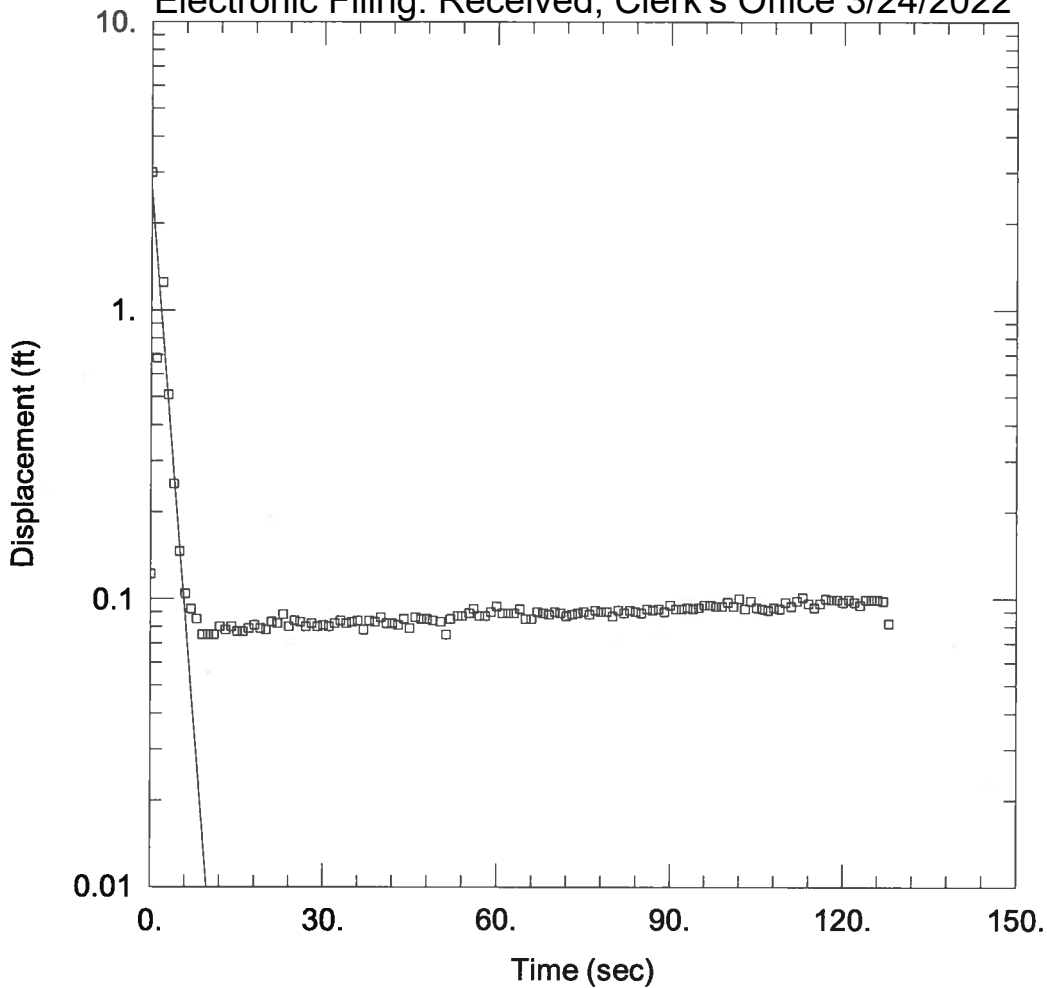

WELL TEST ANALYSIS

Data Set: P:\...\Joliet 29 mw-11 u2.aqt

Date: 02/17/11

Time: 09:38:17

PROJECT INFORMATION

Company: Patrick Engineering

Client: Midwest Generation

Project: 21053.070

Location: Joliet #29

Test Well: MW-11 (u2)

Test Date: 12/22/10

AQUIFER DATA

Saturated Thickness: 8.22 ft

Anisotropy Ratio ( $K_z/K_r$ ): 1.

WELL DATA (MW-11 (u2))

Initial Displacement: 3. ft

Static Water Column Height: 8.22 ft

Total Well Penetration Depth: 42.35 ft

Screen Length: 10. ft

Casing Radius: 0.2 ft

Well Radius: 0.085 ft

Gravel Pack Porosity: 0.

SOLUTION

Aquifer Model: Unconfined

Solution Method: Bouwer-Rice

$K = 0.004685$  ft/sec

$y_0 = 2.66$  ft

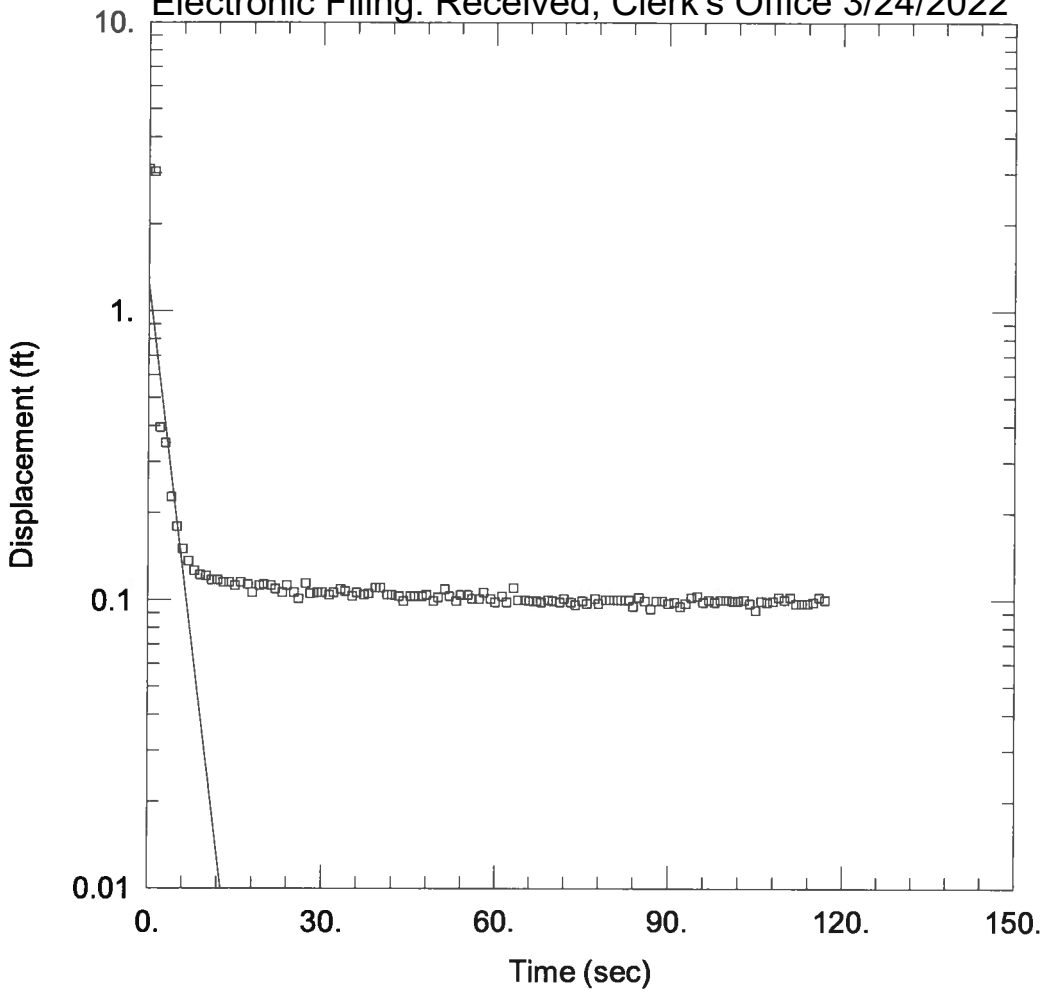

WELL TEST ANALYSIS

Data Set: P:\...\Joliet 29 mw-11 d1.aqt

Date: 02/17/11

Time: 09:42:17

PROJECT INFORMATION

Company: Patrick Engineering

Client: Midwest Generation

Project: 21053.070

Location: Joliet #29

Test Well: MW-11 (d1)

Test Date: 12/22/10

AQUIFER DATA

Saturated Thickness: 8.22 ft

Anisotropy Ratio (Kz/Kr): 1.

WELL DATA (MW-11 (d1))

Initial Displacement: 3.1 ft

Static Water Column Height: 8.22 ft

Total Well Penetration Depth: 42.35 ft

Screen Length: 10. ft

Casing Radius: 0.2 ft

Well Radius: 0.085 ft

Gravel Pack Porosity: 0.

SOLUTION

Aquifer Model: Unconfined

Solution Method: Bouwer-Rice

K = 0.003131 ft/sec

y0 = 1.243 ft

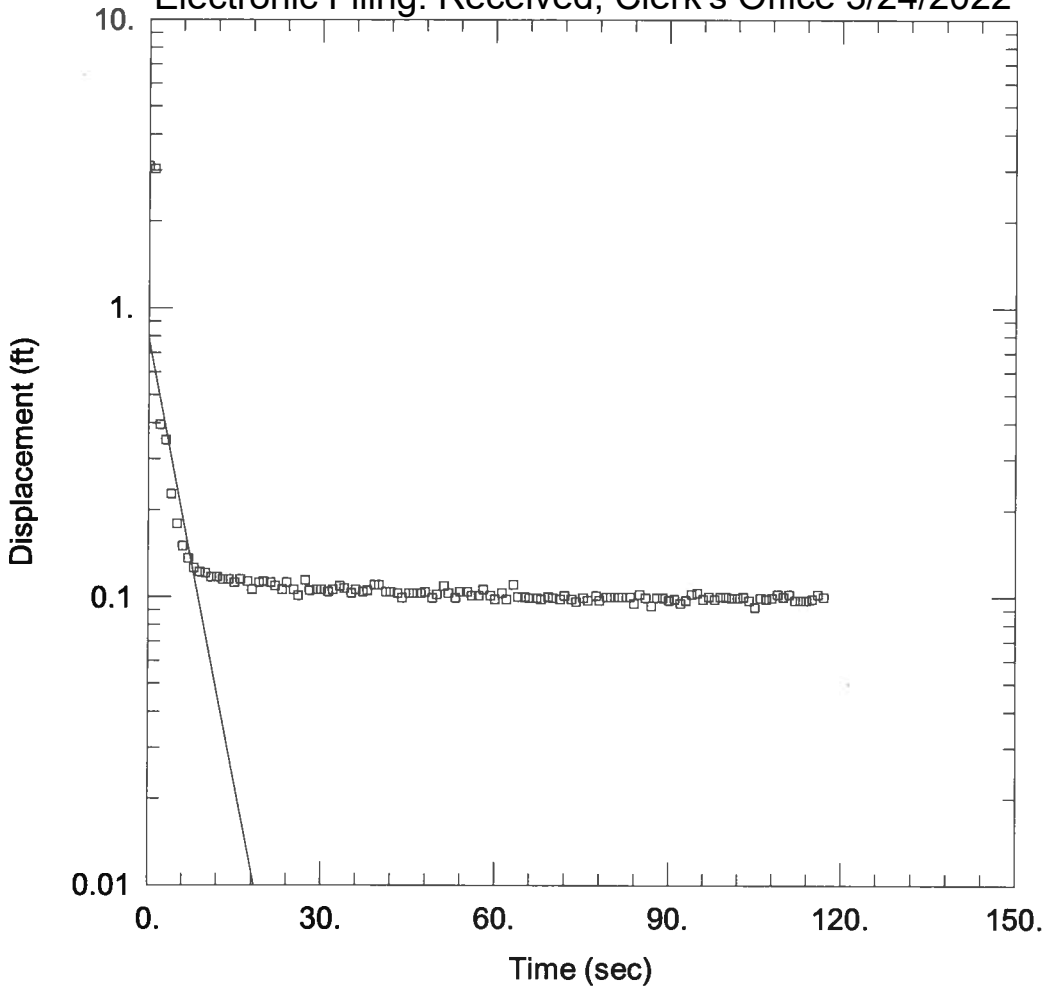

WELL TEST ANALYSIS

Data Set: P:\...\Joliet 29 mw-9 u2.aqt  
 Date: 02/17/11

Time: 09:10:24

PROJECT INFORMATION

Company: Patrick Engineering  
 Client: Midwest Generation  
 Project: 21053.070  
 Location: Joliet #29  
 Test Well: MW-9 (u2)  
 Test Date: 12/22/10

AQUIFER DATA

Saturated Thickness: 8.22 ft

Anisotropy Ratio (Kz/Kr): 1.

WELL DATA (MW-9 (u2))

Initial Displacement: 3.1 ft  
 Total Well Penetration Depth: 42.35 ft  
 Casing Radius: 0.2 ft

Static Water Column Height: 8.22 ft  
 Screen Length: 10. ft  
 Well Radius: 0.085 ft  
 Gravel Pack Porosity: 0.

SOLUTION

Aquifer Model: Unconfined  
 K = 0.001948 ft/sec

Solution Method: Bouwer-Rice  
 y0 = 0.787 ft





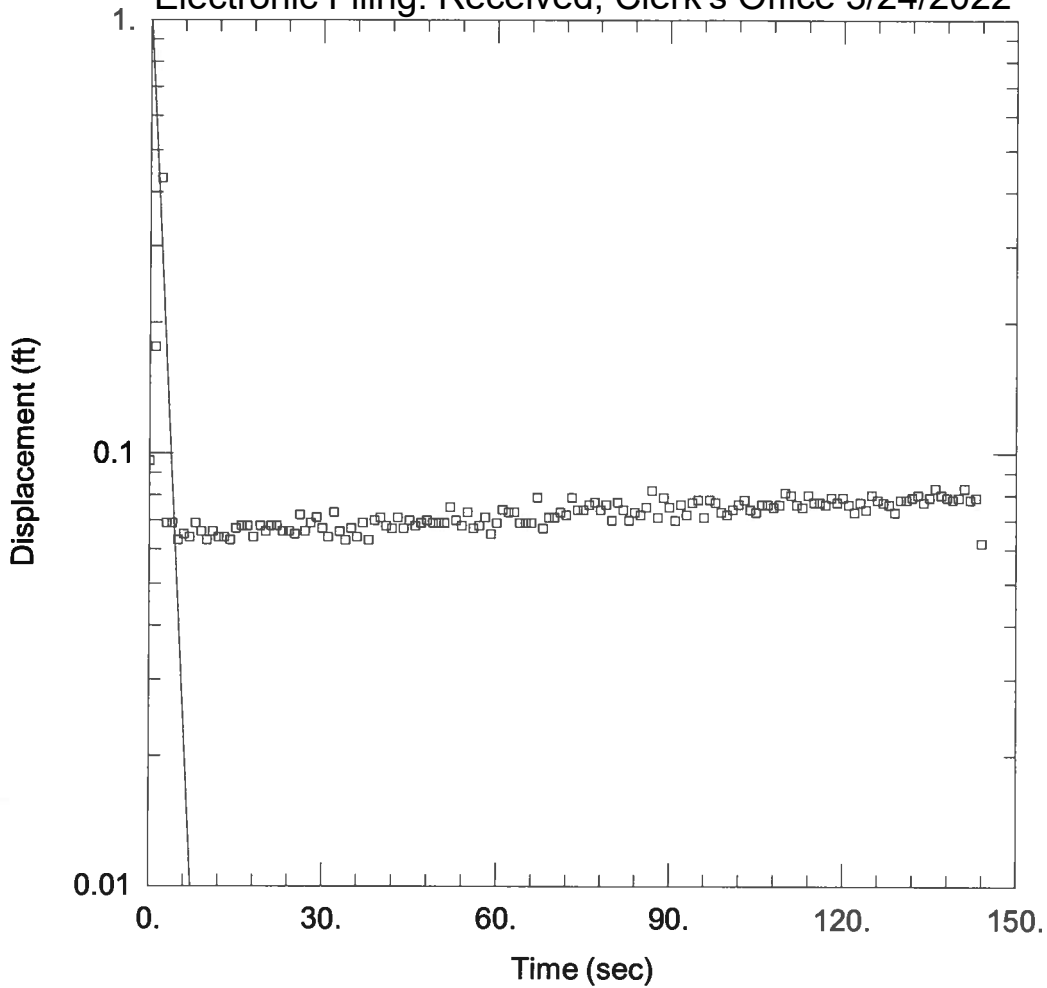

WELL TEST ANALYSIS

Data Set: P:\...\Joliet 29 mw-6 u1.aqt  
 Date: 02/17/11

Time: 09:11:59

PROJECT INFORMATION

Company: Patrick Engineering  
 Client: Midwest Generation  
 Project: 21053.070  
 Location: Joliet #29  
 Test Well: MW-6 (u1)  
 Test Date: 12/22/10

AQUIFER DATA

Saturated Thickness: 8.22 ft

Anisotropy Ratio (Kz/Kr): 1.

WELL DATA (MW-6 (u1))

Initial Displacement: 3. ft  
 Total Well Penetration Depth: 42.2 ft  
 Casing Radius: 0.2 ft

Static Water Column Height: 8.22 ft  
 Screen Length: 10. ft  
 Well Radius: 0.085 ft  
 Gravel Pack Porosity: 0.

SOLUTION

Aquifer Model: Unconfined  
 K = 0.005274 ft/sec

Solution Method: Bouwer-Rice  
 y0 = 1.109 ft

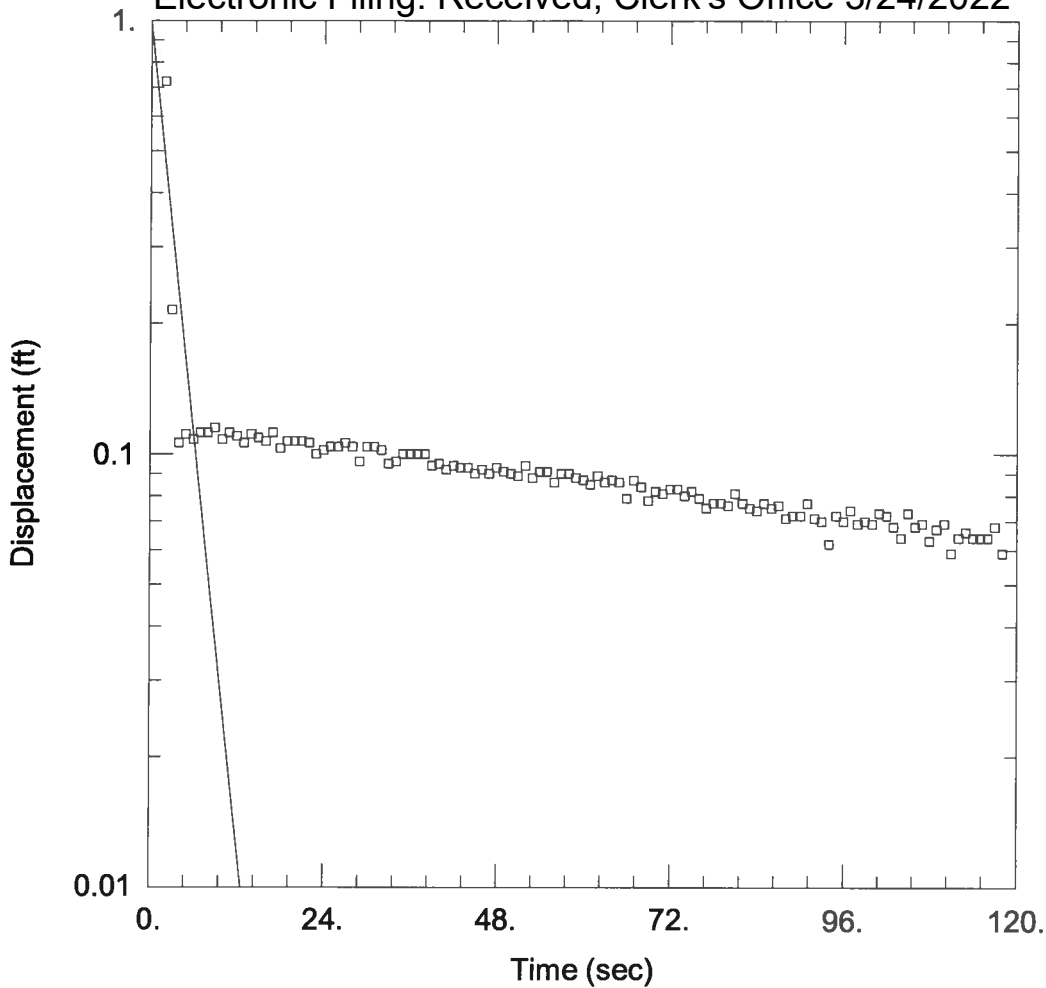

WELL TEST ANALYSIS

Data Set: P:\...\Joliet 29 mw-6 d2.aqt  
 Date: 02/17/11

Time: 09:13:14

PROJECT INFORMATION

Company: Patrick Engineering  
 Client: Midwest Generation  
 Project: 21053.070  
 Location: Joliet #29  
 Test Well: MW-6 (d2)  
 Test Date: 12/22/10

AQUIFER DATA

Saturated Thickness: 8.22 ft

Anisotropy Ratio (Kz/Kr): 1.

WELL DATA (MW-6 (d2))

Initial Displacement: 3. ft  
 Total Well Penetration Depth: 42.2 ft  
 Casing Radius: 0.2 ft

Static Water Column Height: 8.22 ft  
 Screen Length: 10. ft  
 Well Radius: 0.085 ft  
 Gravel Pack Porosity: 0.

SOLUTION

Aquifer Model: Unconfined  
 K = 0.002987 ft/sec

Solution Method: Bouwer-Rice  
 y0 = 0.9913 ft

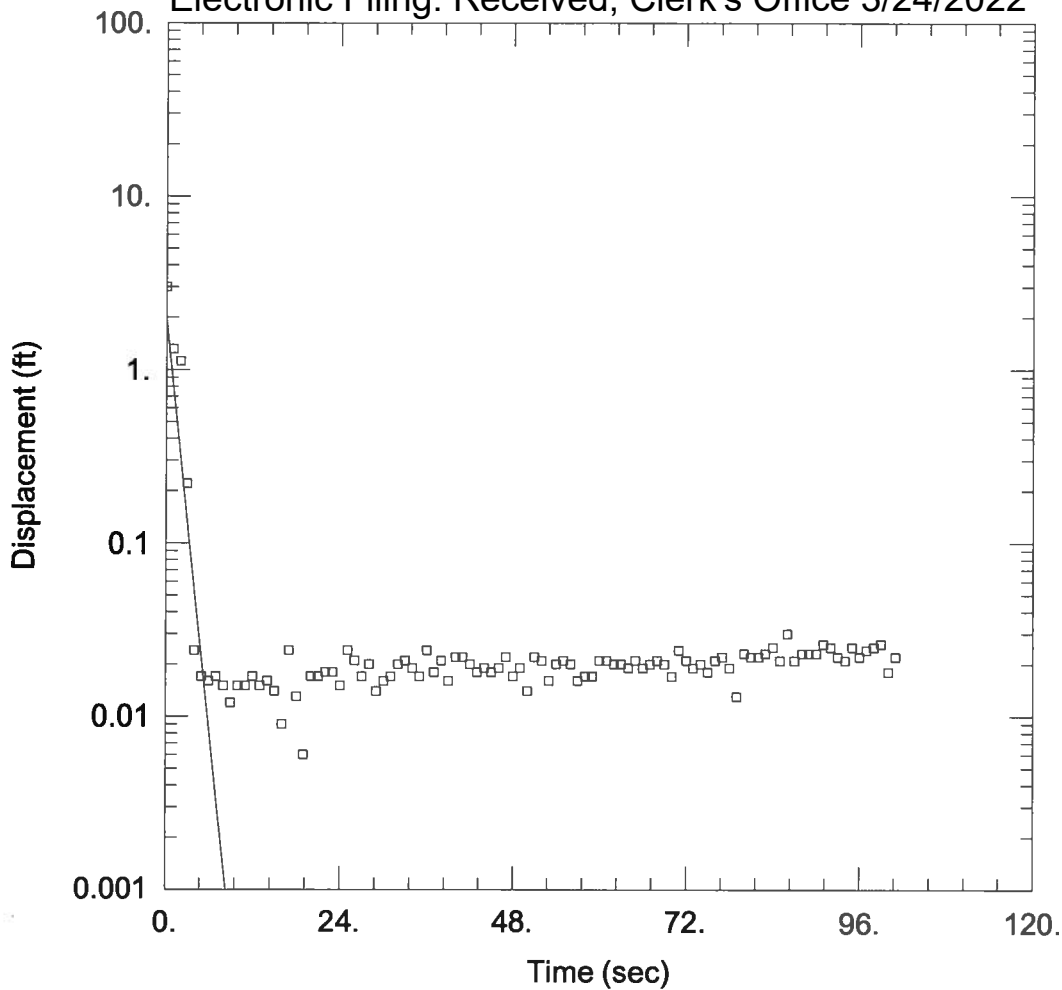

WELL TEST ANALYSIS

Data Set: P:\...\Joliet 29 mw-4 u2.aqt  
 Date: 02/17/11

Time: 09:47:55

PROJECT INFORMATION

Company: Patrick Engineering  
 Client: Midwest Generation  
 Project: 21053.070  
 Location: Joliet #29  
 Test Well: MW-4 (u2)  
 Test Date: 12/22/10

AQUIFER DATA

Saturated Thickness: 8.86 ft

Anisotropy Ratio (Kz/Kr): 1.

WELL DATA (MW-4 (u2))

Initial Displacement: 3. ft  
 Total Well Penetration Depth: 42.9 ft  
 Casing Radius: 0.2 ft

Static Water Column Height: 8.86 ft  
 Screen Length: 10. ft  
 Well Radius: 0.085 ft  
 Gravel Pack Porosity: 0.

SOLUTION

Aquifer Model: Unconfined  
 K = 0.006949 ft/sec

Solution Method: Bouwer-Rice  
 y0 = 1.978 ft

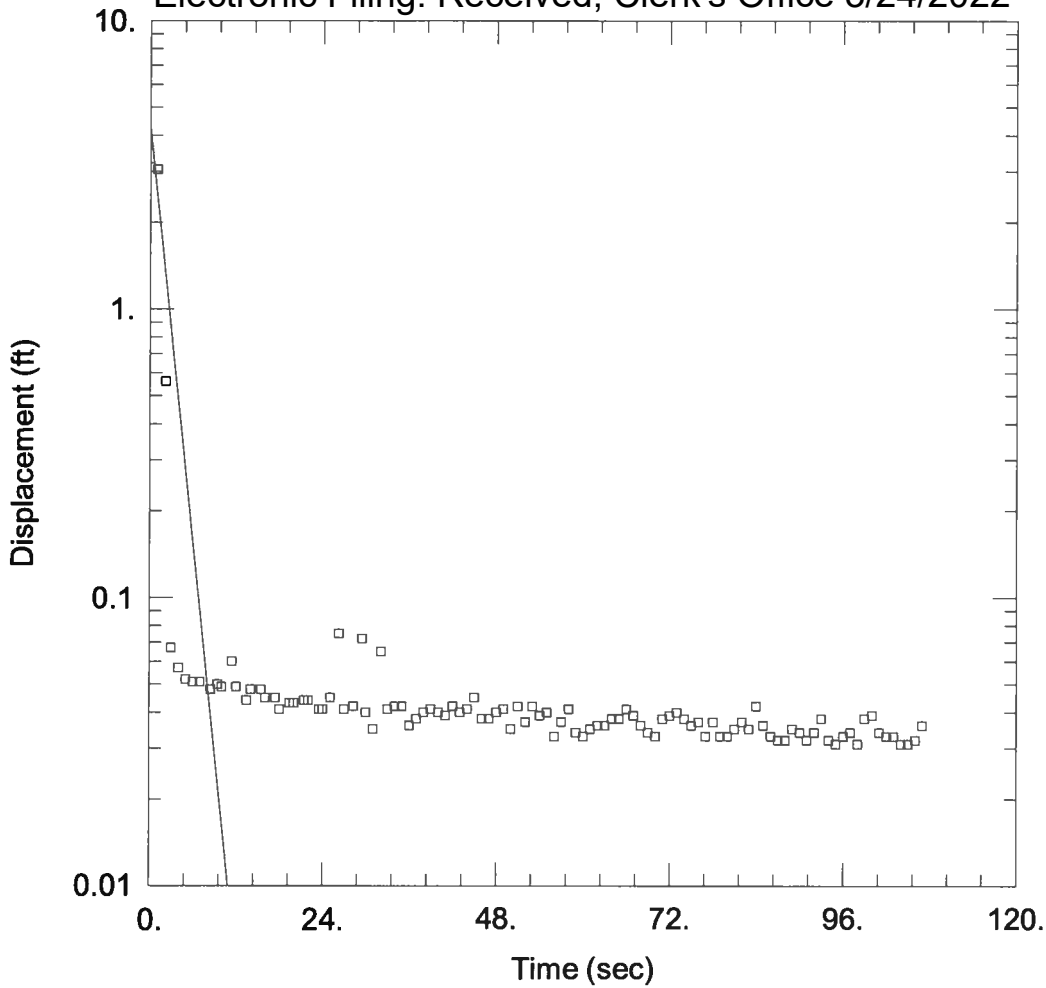

WELL TEST ANALYSIS

Data Set: P:\...\Joliet 29 mw-4 d1.aqt  
 Date: 02/17/11

Time: 09:13:56

PROJECT INFORMATION

Company: Patrick Engineering  
 Client: Midwest Generation  
 Project: 21053.070  
 Location: Joliet #29  
 Test Well: MW-4 (d1)  
 Test Date: 12/22/10

AQUIFER DATA

Saturated Thickness: 8.86 ft

Anisotropy Ratio (Kz/Kr): 1.

WELL DATA (MW-4 (d1))

Initial Displacement: 3.1 ft  
 Total Well Penetration Depth: 42.9 ft  
 Casing Radius: 0.2 ft

Static Water Column Height: 8.86 ft  
 Screen Length: 10. ft  
 Well Radius: 0.085 ft  
 Gravel Pack Porosity: 0.

SOLUTION

Aquifer Model: Unconfined  
 K = 0.004267 ft/sec

Solution Method: Bouwer-Rice  
 y0 = 4.312 ft

# **ATTACHMENT 3**

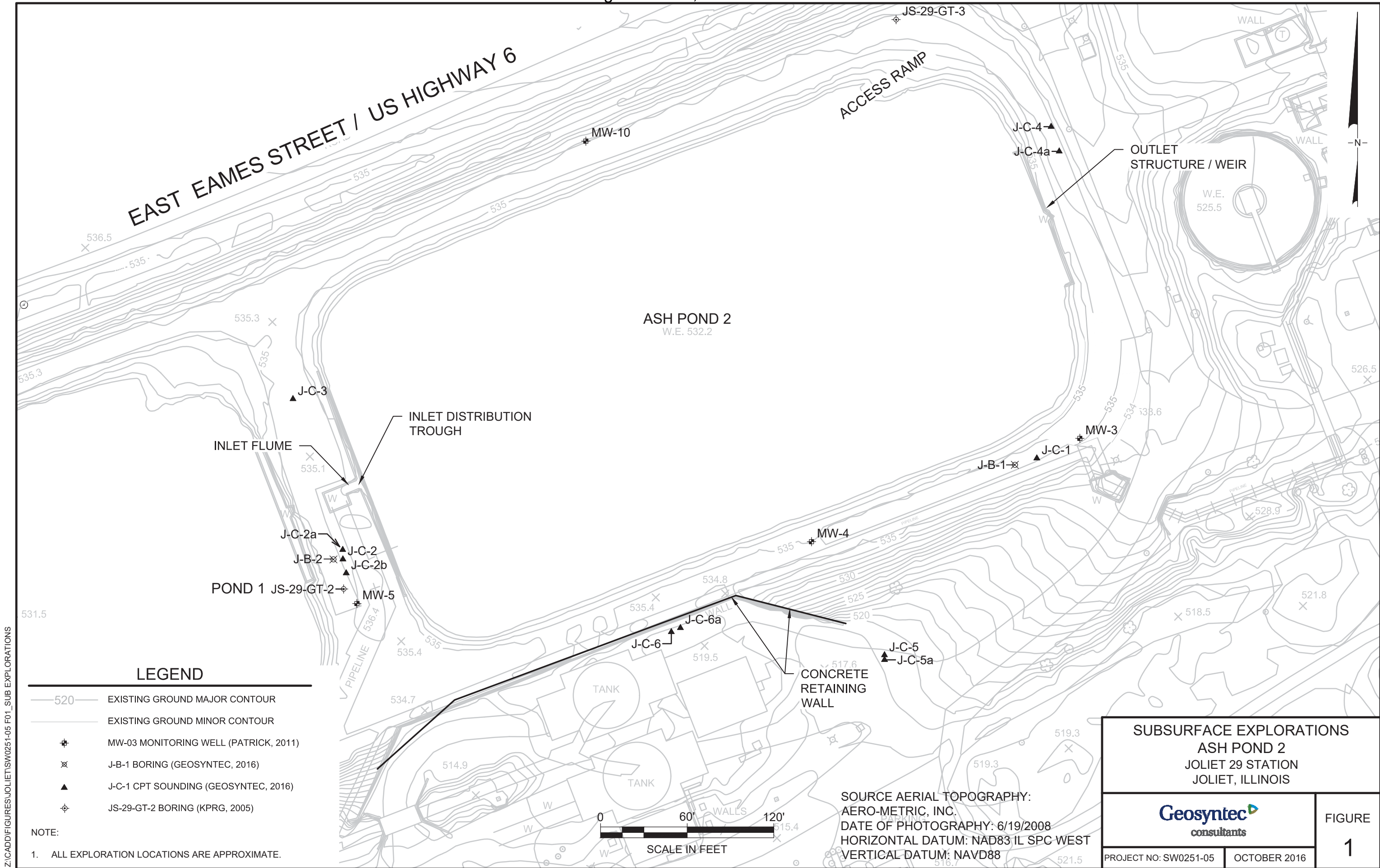

**LEGEND**

- 520— EXISTING GROUND MAJOR CONTOUR
- EXISTING GROUND MINOR CONTOUR
- ⊕ MW-03 MONITORING WELL (PATRICK, 2011)
- ⊗ J-B-1 BORING (GEOSYNTEC, 2016)
- ▲ J-C-1 CPT SOUNDING (GEOSYNTEC, 2016)
- ⊕ JS-29-GT-2 BORING (KPRG, 2005)

NOTE:

1. ALL EXPLORATION LOCATIONS ARE APPROXIMATE.

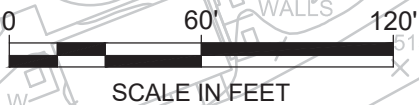

SOURCE AERIAL TOPOGRAPHY:  
 AERO-METRIC, INC.  
 DATE OF PHOTOGRAPHY: 6/19/2008  
 HORIZONTAL DATUM: NAD83 IL SPC WEST  
 VERTICAL DATUM: NAVD88

SUBSURFACE EXPLORATIONS  
 ASH POND 2  
 JOLIET 29 STATION  
 JOLIET, ILLINOIS



PROJECT NO: SW0251-05    OCTOBER 2016

FIGURE

1

Z:\CADD\FIGURES\JOLIET\SW0251-05\F01\_SUB EXPLORATIONS

**KEY SHEET - CLASSIFICATIONS AND SYMBOLS**

GS FORM:  
KEY 09/99

**EMPIRICAL CORRELATIONS WITH STANDARD PENETRATION RESISTANCE N VALUES \***

	N VALUE * (BLOWS/FT)	CONSISTENCY	UNCONFINED COMPRESSIVE STRENGTH (TONS/SQ FT)		N VALUE * (BLOWS/FT)	RELATIVE DENSITY
<b>FINE GRAINED SOILS</b>	0 - 2	VERY SOFT	<0.25	<b>COARSE GRAINED SOILS</b>	0 - 4	VERY LOOSE
	3 - 4	SOFT	0.25 - 0.50		5 - 10	LOOSE
	5 - 8	FIRM	0.50 - 1.00		11 - 30	MEDIUM DENSE
	9 - 15	STIFF	1.00 - 2.00		31 - 50	DENSE
	16 - 30	VERY STIFF	2.00 - 4.00		>50	VERY DENSE
	31 - 50	HARD	>4.00			
	>50	VERY HARD				

\* ASTM D 1586; NUMBER OF BLOWS OF 140 POUND HAMMER FALLING 30 INCHES TO DRIVE A 2 IN. O.D., 1.4 IN. I.D. SAMPLER ONE FOOT.

**UNIFIED SOIL CLASSIFICATION AND SYMBOL CHART**

MAJOR DIVISIONS		SYMBOLS	DESCRIPTIONS
<b>COARSE GRAINED SOILS</b>	GRAVEL AND GRAVELLY SOILS	CLEAN GRAVELS	GW WELL-GRADED GRAVELS, GRAVEL-SAND MIXTURES, LITTLE OR NO FINES
		LITTLE OR NO FINES	GP POORLY GRADED GRAVELS, GRAVEL-SAND MIXTURES, LITTLE OR NO FINES
		GRAVELS WITH FINES	GM SILTY GRAVELS, GRAVEL- SAND-SILT MIXTURES
	MORE THAN 50% OF COARSE FRACTION RETAINED ON NO.4 SIEVE	APPRECIABLE AMOUNT OF FINES	GC CLAYEY GRAVELS, GRAVEL -SAND-CLAY MIXTURES
	SAND AND SANDY SOILS	CLEAN SANDS	SW WELL GRADED SANDS, GRAVELLY SANDS, LITTLE OR NO FINES
		LITTLE OR NO FINES	SP POORLY GRADED SANDS, GRAVELLY SANDS, LITTLE OR NO FINES
SANDS WITH FINES		SM SILTY SANDS, SAND-SILT MIXTURES	
MORE THAN 50% OF MATERIAL COARSER THAN NO. 200 SIEVE SIZE	APPRECIABLE AMOUNT OF FINES	SC CLAYEY SANDS, SAND-CLAY MIXTURES	
<b>FINE GRAINED SOILS</b>	SILTS AND CLAYS	Liquid Limit Less Than 50	ML INORGANIC SILTS AND VERY FINE SANDS, ROCK FLOUR, SILTY OR CLAYEY FINE SANDS OR CLAYEY SILTS WITH SLIGHT PLASTICITY
			CL INORGANIC CLAYS OF LOW TO MEDIUM PLASTICITY, GRAVELLY CLAYS, SANDY CLAYS, SILTY CLAYS, LEAN CLAYS
			OL ORGANIC SILTS AND ORGANIC SILTY CLAYS OF LOW PLASTICITY
	SILTS AND CLAYS	Liquid Limit Greater Than 50	MH INORGANIC SILTS, MICACEOUS OR DIATOMACEOUS FINE SANDY OR SILTY SOILS, ELASTIC SILT
			CH INORGANIC CLAYS OF HIGH PLASTICITY, FAT CLAYS
			OH ORGANIC CLAYS OF MEDIUM TO HIGH PLASTICITY, ORGANIC SILTS
<b>HIGHLY ORGANIC SOILS</b>		PT PEAT, HUMUS, SWAMP SOILS WITH HIGH ORGANIC CONTENT	

NOTE: DUAL SYMBOLS USED FOR BORDERLINE CLASSIFICATIONS

**PARTICLE SIZE IDENTIFICATION**

BOULDERS	>300 mm
COBBLES	75 - 300 mm
GRAVEL: COARSE	19.0 - 75 mm
GRAVEL: FINE	4.75 - 19 mm
SAND: COARSE	2.00 - 4.75 mm
SAND: MEDIUM	0.425 - 2.00 mm
SAND: FINE	0.075 - 0.425 mm
SILT	0.075 - 0.002 mm
CLAY	<0.002 mm

WELL GRADED - HAVING WIDE RANGE OF GRAIN SIZES AND APPRECIABLE AMOUNTS OF ALL INTERMEDIATE PARTICLE SIZES

POORLY GRADED - PREDOMINANTLY ONE GRAIN SIZE, OR HAVING A RANGE OF SIZES WITH SOME INTERMEDIATE SIZES MISSING

**PLASTICITY CHART**

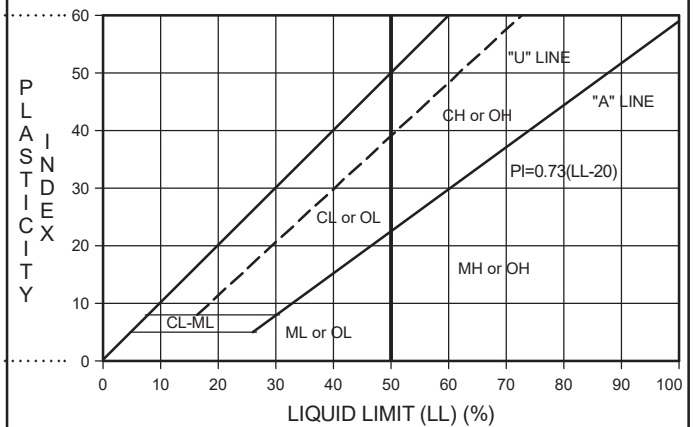

**OTHER MATERIAL SYMBOLS**

Siltstone	Sand
Sandstone	Silt
Siltstone/Claystone	Silty Sand
Claystone	Alluvium
Shale	Artificial Fill
Siltstone/Sandstone	Debris Fill
Conglomerate	Asphalt
Granitic	Cement

**WELL SYMBOLS**

GRANULAR BENTONITE
BENTONITE CEMENT GROUT
FILTER PACK
CONCRETE
NATIVE/SLOUGH
CENTRAL-IZER

**SAMPLER AND OTHER SYMBOLS**

GRAB SAMPLE	Water Level at Time Drilling, or as Shown
SPLIT SPOON	Static Water Level
STANDARD PENETRATION TEST (SPT)	MSL: Mean Sea Level
SHELBY TUBE	MC: Moisture Content
CALIFORNIA SAMPLER	WA: #200 Wash
BULK SAMPLE	DD: Dry Density
	SA: Sieve Analysis
	PI: Plasticity Index
	SG: Specific Gravity
	LL: Liquid Limit
	c: Cohesion
	K: Hydraulic Conductivity
	Phi: Friction Angle





16644 West Bernardo Dr., Suite 301  
 San Diego, CA 92127  
 Tel: (858) 674-6559  
 Fax: (858) 674-6586

**BORING J-B-1**  
**START DATE 12/17/2015**  
**FINISH DATE 12/17/2015**  
**PROJECT Joliet Station**  
**LOCATION Joliet, IL**  
**PROJECT NUMBER SW0251-05**

**SHEET 1 OF 2**  
**ELEVATION 535.0 FT MSL**

GS FORM:  
 BORE 1/99

**BOREHOLE RECORD**

DEPTH (ft)	MATERIAL DESCRIPTION	SYMBOLIC LOG	ELEVATION (ft)	SAMPLES					COMMENTS
				NUMBER	TYPE	BLOW COUNTS	N VALUE	% RECOVERY	
5	<b>FILL:</b> 2 inches of gravel over lean CLAY with sand (CL); light brown; moist; stiff; trace gravel and medium to fine sand  Sand and gravel decreases		530	J-B-1-1					MC: 15.2 SA: 80.7 LL: 46, PI: 25
				J-B-1-2		5/8/11		100	MC: 18.3 SA: 89.9 PP: 4.5 tsf LL: 43 PI: 23
10	Silty GRAVEL with sand (GM); black and tan; moist; medium dense; coarse angular gravel		525	J-B-1-3		21/22/8		80	Drive casing to 10' MC: 12.2 SA: 29.4
15	<b>NATIVE:</b> Well-graded GRAVEL with silt and sand (GW-GM); tan; moist; very dense; large coarse rounded and angular gravel; limestone fragments		520	J-B-1-4		20/40/50		70	MC: 5.6 SA: 7.5 Sample placed in bag
20	Poorly graded GRAVEL with silt and sand (GP-GM); light brown; moist; very dense; fine angular gravel; limestone fragments		515	J-B-1-5		11/55/5"		80	Rig chatter @ 20' MC: 6.0 SA: 10.7
25	Silty GRAVEL with sand (GM); limestone fragments; tan and grey; moist; very dense; coarse to medium sand		510	J-B-1-6		42/50/5"		80	MC: 9.9 SA: 21.8
30			505						

BORING LOG GEOTECH (SW0251) SW0251-05.GPJ SAN DIEGO GINT LIBRARY.GLB 10/12/16

**CONTRACTOR** Strata  
**EQUIPMENT** Mobile B57  
**DRILL MTHD** Mud Rotary  
**DIAMETER** 6"  
**LOGGER** J. Griffin  
**REVIEWER** J. Soule  
**NORTHING** 15074043.60  
**EASTING** 1333763.03  
**ANGLE** Vertical  
**BEARING** ----  
**PRINTED** 10/12/16

**REMARKS:** California sampler used 3" O.D. split barrel sampler lined with thin-walled brass tubes. No groundwater observed during mud rotary drilling.  
**COORDINATE SYSTEM:**  
 SEE KEY SHEET FOR SYMBOLS AND ABBREVIATIONS



16644 West Bernardo Dr., Suite 301  
 San Diego, CA 92127  
 Tel: (858) 674-6559  
 Fax: (858) 674-6586

**BORING J-B-1** **SHEET 2 OF 2**  
**START DATE 12/17/2015** **ELEVATION 535.0 FT MSL**  
**FINISH DATE 12/17/2015**  
**PROJECT Joliet Station**  
**LOCATION Joliet, IL**  
**PROJECT NUMBER SW0251-05**

GS FORM:  
BORE 1/99

**BOREHOLE RECORD**

DEPTH (ft)	MATERIAL DESCRIPTION	SYMBOLIC LOG	ELEVATION (ft)	SAMPLES					TIME	COMMENTS
				NUMBER	TYPE	BLOW COUNTS	N VALUE	% RECOVERY		
31.5	Tan gravel		535.0	J-B-1-7		11/11/17		40		100% drilling mud loss @ 30'
31.5	END OF BORING @ 31.5' BACKFILL WITH GROUT		500							
40			495							
45			490							
50			485							
55			480							
60			475							

BORING LOG GEOTECH (SW0251) SW0251-05.GPJ SAN DIEGO GINT LIBRARY.GLB 10/12/16

**CONTRACTOR** Strata **NORTHING** 15074043.60  
**EQUIPMENT** Mobile B57 **EASTING** 1333763.03  
**DRILL MTHD** Mud Rotary **ANGLE** Vertical  
**DIAMETER** 6" **BEARING** ----  
**LOGGER** J. Griffin **REVIEWER** J. Soule **PRINTED** 10/12/16

**REMARKS:** California sampler used 3" O.D. split barrel sampler lined with thin-walled brass tubes. No groundwater observed during mud rotary drilling.  
**COORDINATE SYSTEM:**  
 SEE KEY SHEET FOR SYMBOLS AND ABBREVIATIONS



16644 West Bernardo Dr., Suite 301  
 San Diego, CA 92127  
 Tel: (858) 674-6559  
 Fax: (858) 674-6586

**BORING J-B-2** **SHEET 1 OF 2**  
**START DATE 12/17/2015** **ELEVATION 535.0 FT MSL**  
**FINISH DATE 12/17/2015**  
**PROJECT Joliet Station**  
**LOCATION Joliet, IL**  
**PROJECT NUMBER SW0251-05**

GS FORM:  
BORE 1/99

**BOREHOLE RECORD**

DEPTH (ft)	MATERIAL DESCRIPTION	SYMBOLIC LOG	ELEVATION (ft)	SAMPLES					COMMENTS	
				NUMBER	TYPE	BLOW COUNTS	N VALUE	% RECOVERY		TIME
0	<u>FILL:</u> Silty SAND with gravel (SM); moist; brown									
5	Silty GRAVEL with sand (GM); black; moist; medium dense; angular coarse gravel and coarse to fine sand		530	J-B-2-1						
				J-B-2-2		11/7/7		80		MC: 11.8 SA: 20.1
10	Coarse limestone fragments		525	J-B-2-3		4/7/4		50		Drive casing to 10'
15	Poorly graded GRAVEL with silt (GP-GM); tan and black; moist; medium dense to dense; fine gravel and trace sand		520	J-B-2-4		9/15/12		0		No recovery
				J-B-2-5		10/21/18		10		MC: 9.2 SA: 7.1
20	<u>NATIVE:</u> Poorly graded GRAVEL with silt and sand (GP-GM); red; moist; medium dense to dense; limestone fragments.		515	J-B-2-6		8/8/11		5		Casing to 20'; 100% drilling mud loss at 20'; No sample recovered for J-B-2-6
25			510	J-B-2-7		18/22/23		70		3" SS no liners to attempt better recovery MC: 6.6 SA: 7.5
30			505							Casing to 30', no liner

BORING LOG GEOTECH (SW0251) SW0251-05.GPJ SAN DIEGO GINT LIBRARY.GLB 10/12/16

**CONTRACTOR** Strata **NORTHING** 15073969.82  
**EQUIPMENT** Mobile B57 **EASTING** 1333284.12  
**DRILL MTHD** Mud Rotary **ANGLE** Vertical  
**DIAMETER** 6" **BEARING** ----  
**LOGGER** J. Griffin **REVIEWER** J. Soule **PRINTED** 10/12/16

**REMARKS:** California sampler used 3" O.D. split barrel sampler lined with thin-walled brass tubes. No groundwater observed during mud rotary drilling.  
**COORDINATE SYSTEM:**  
 SEE KEY SHEET FOR SYMBOLS AND ABBREVIATIONS



16644 West Bernardo Dr., Suite 301  
 San Diego, CA 92127  
 Tel: (858) 674-6559  
 Fax: (858) 674-6586

**BORING J-B-2**  
**START DATE 12/17/2015**  
**FINISH DATE 12/17/2015**  
**PROJECT Joliet Station**  
**LOCATION Joliet, IL**  
**PROJECT NUMBER SW0251-05**

**SHEET 2 OF 2**  
**ELEVATION 535.0 FT MSL**

GS FORM:  
BORE 1/99

**BOREHOLE RECORD**

DEPTH (ft)	MATERIAL DESCRIPTION	SYMBOLIC LOG	ELEVATION (ft)	SAMPLES					TIME	COMMENTS
				NUMBER	TYPE	BLOW COUNTS	N VALUE	% RECOVERY		
	Poorly graded GRAVEL (GP); fine gravel; some sand and trace silt; tan; moist; very dense			J-B-2-8		22/21/24		70		MC: 6.2 SA: 2.7
35			500	J-B-2-9		36/36/27		80		Casing to 35', no liner
	END OF BORING @ 36.5' REMOVE CASING AND BACKFILL WITH GROUT									
40			495							
45			490							
50			485							
55			480							
60			475							







BORING LOG GEOTECH (SW0251) SW0251-05.GPJ SAN DIEGO GINT LIBRARY.GLB 10/12/16

**CONTRACTOR** Strata      **NORTHING** 15073969.82  
**EQUIPMENT** Mobile B57      **EASTING** 1333284.12  
**DRILL MTHD** Mud Rotary      **ANGLE** Vertical  
**DIAMETER** 6"      **BEARING** ----  
**LOGGER** J. Griffin      **REVIEWER** J. Soule      **PRINTED** 10/12/16

**REMARKS:** California sampler used 3" O.D. split barrel sampler lined with thin-walled brass tubes. No groundwater observed during mud rotary drilling.  
**COORDINATE SYSTEM:**  
 SEE KEY SHEET FOR SYMBOLS AND ABBREVIATIONS

# **ATTACHMENT 4**

**LEGEND**

-  EXISTING GROUND MAJOR CONTOUR (5')
-  EXISTING GROUND MINOR CONTOUR (1')
-  PROPOSED GRADING MAJOR CONTOUR (5')
-  PROPOSED GRADING MINOR CONTOUR (1')
-  PROPOSED LIMIT OF GRADING
-  GRADE BREAK

**NOTES:**

1. SOURCE AERIAL TOPOGRAPHY: AERO-METRIC, INC. DATE OF PHOTOGRAPHY: 6/17/2008.
2. EARTHWORK VOLUME = 100 CY
3. FILL (CA-6 AGGREGATE) SHALL BE PLACED WITH A MAXIMUM LOOSE LIFT THICKNESS OF 10 INCHES WITH A MAXIMUM COMPACTED LIFT THICKNESS OF 6 INCHES. FILL SHALL BE COMPACTED BY A MINIMUM OF 3 PASSES WITH A CAT 34B OR EQUIVALENT SMOOTH DRUM ROLLER (MINIMUM OPERATING WEIGHT OF 8,000 lbs. AND MINIMUM CENTRIFUGAL FORCE PER DRUM OF 5,000 lbs.) AND SHALL BE FIRM AND UNYIELDING.

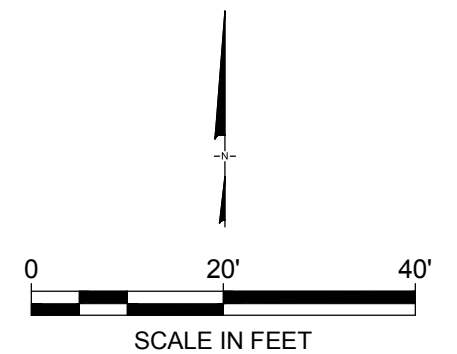
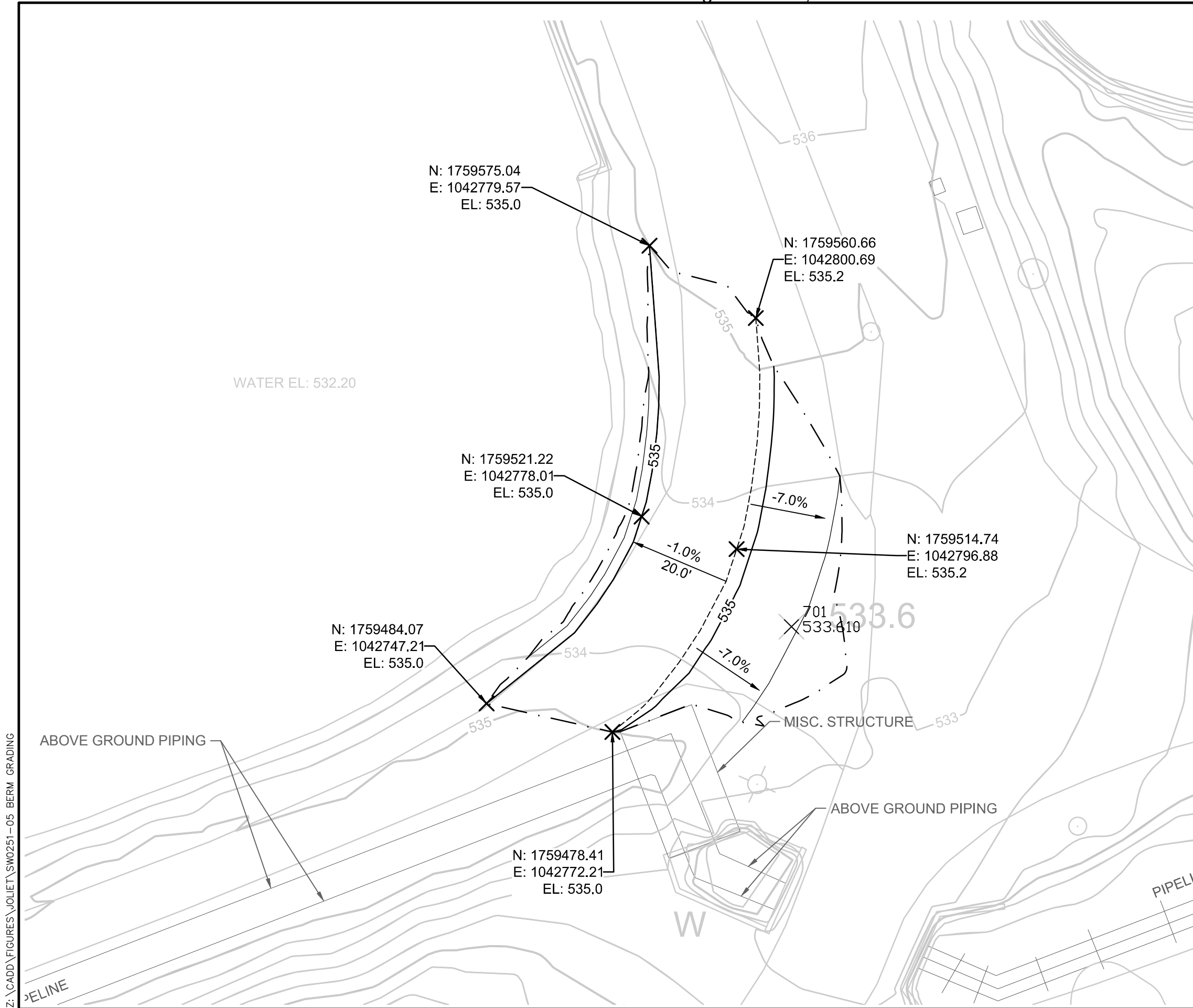

<b>PROPOSED BERM GRADING</b> JOLIET 29 STATION JOLIET, ILLINOIS	
	<b>FIGURE</b> <span style="font-size: 2em; font-weight: bold;">1</span>
PROJECT NO: SW0251-05	AUGUST 2016

Z:\CADD\FIGURES\JOLIET\SW0251-05 BERM GRADING







5079C5019 SH3

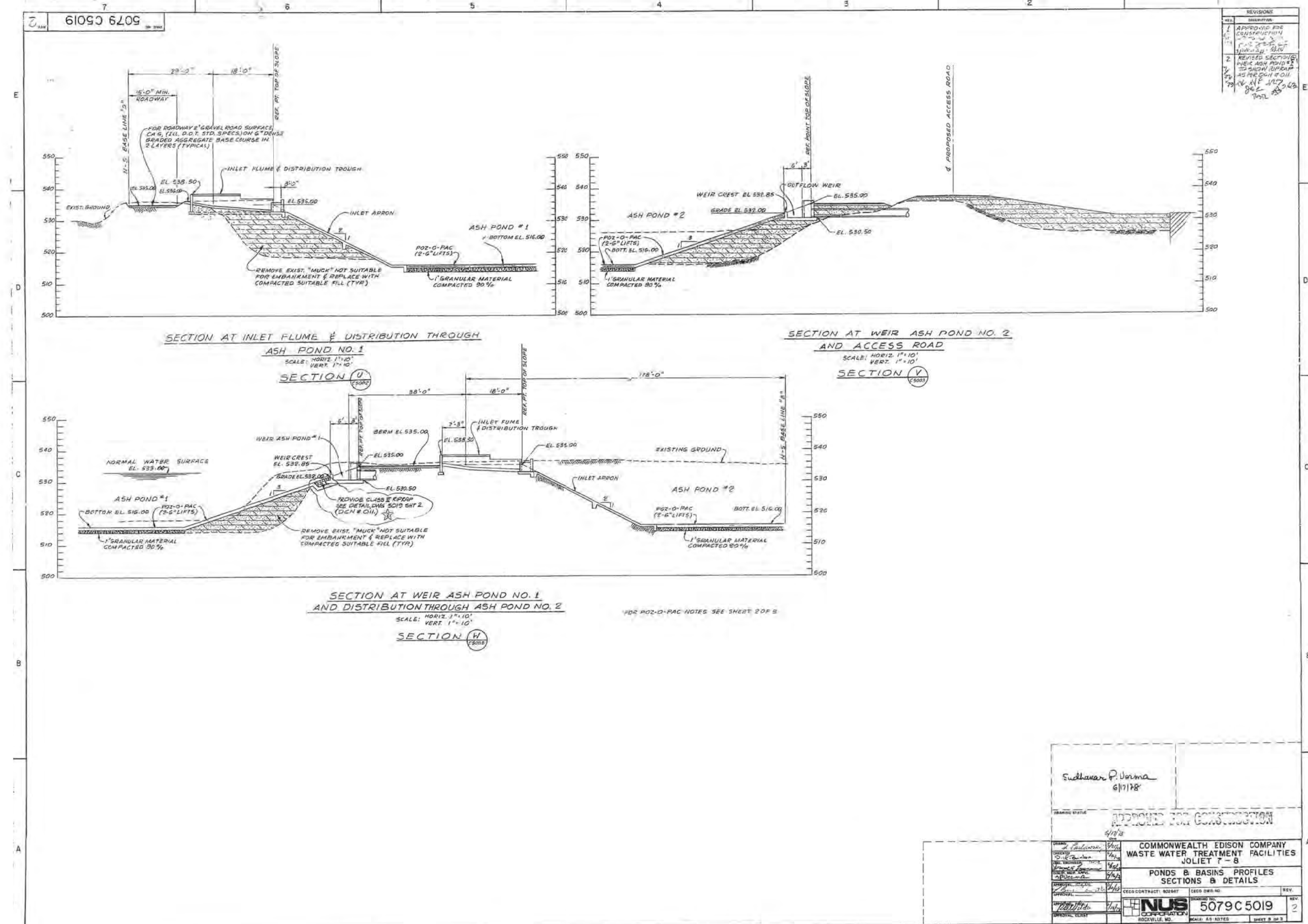

5079C5019 SH2

REV.	DESCRIPTION
1	APPROVED FOR CONSTRUCTION
2	REVISED POZ-O-PAC WITH NOTE 2 AS PER DCN # 002
3	ADDED RIPRAP DETAIL ACCESS RAMP DETAIL ADDED RIPRAP TO THE SECTION THROUGH ASH POND #1 AS PER DCN # 011

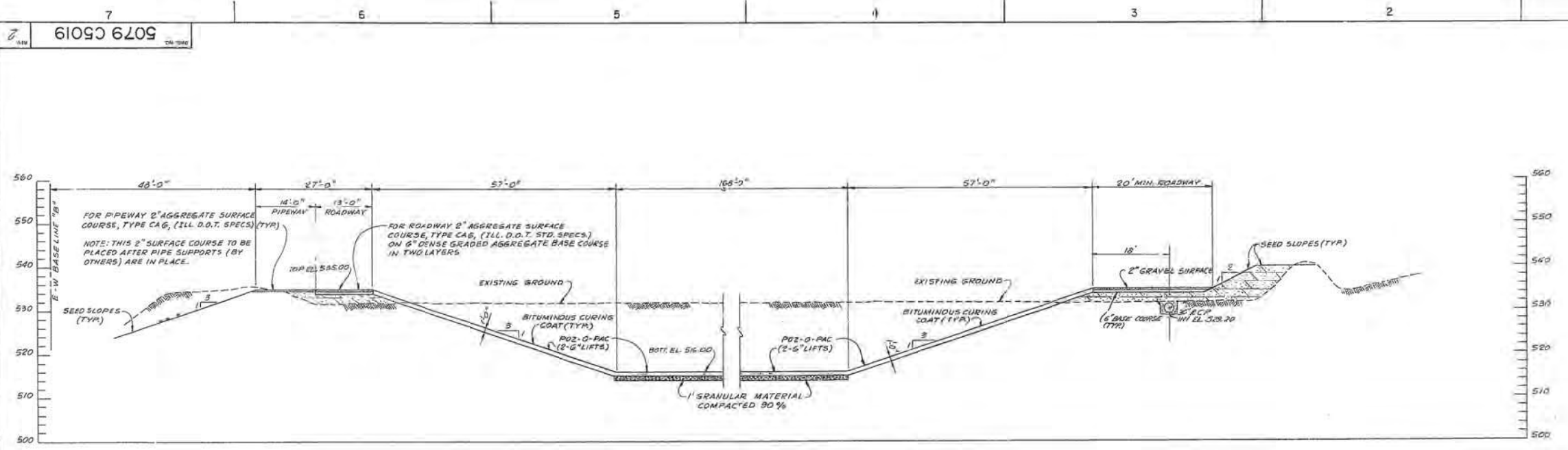

TYPICAL SECTION THROUGH ASH POND NO. 2  
SCALE: HORIZ. 1" = 10'  
VERT. 1" = 10'  
SECTION 5

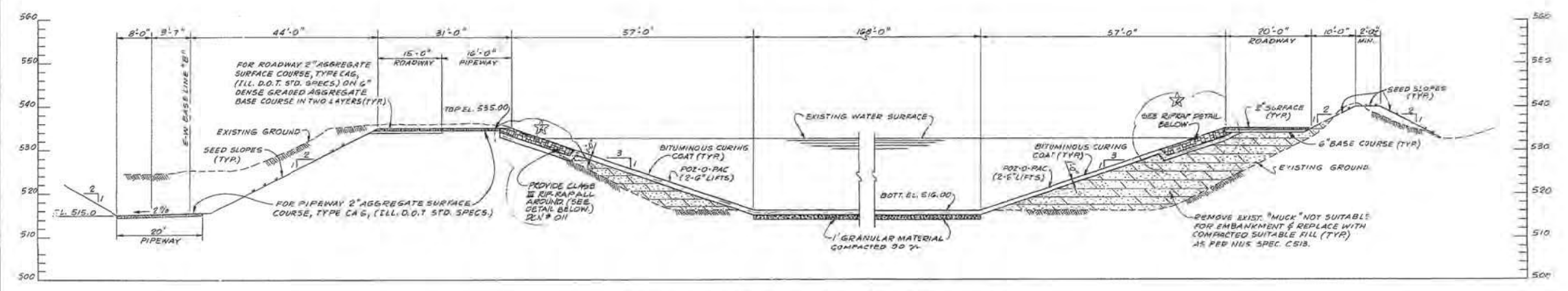

TYPICAL SECTION THROUGH ASH POND NO. 1  
SCALE: HORIZ. 1" = 10'  
VERT. 1" = 10'  
SECTION 7

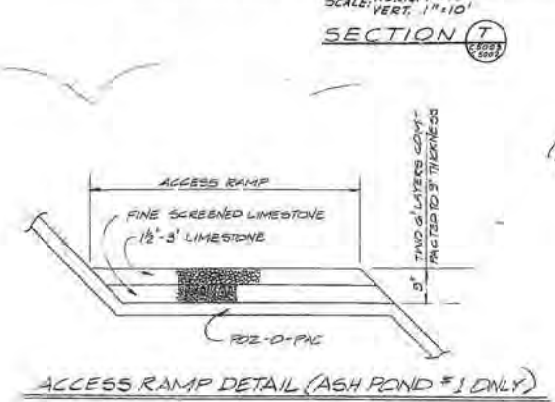
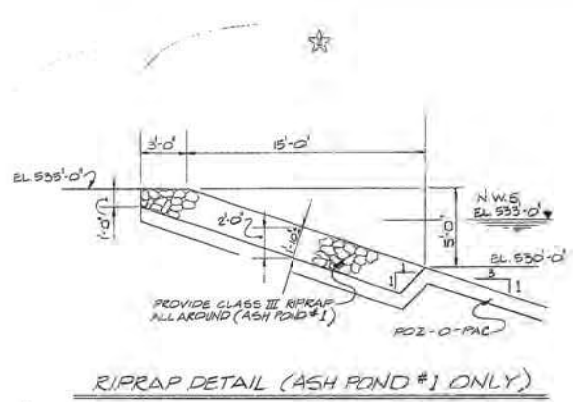

- POZ-O-PAC NOTES:**
- ALLOW A MINIMUM OF 7 DAYS CURING OF POZ-O-PAC PRIOR TO APPLICATION OF THE BITUMINOUS SEAL COAT.
  - THE POZ-O-PAC SHALL BE COMPOSED OF THE FOLLOWING MIX: 1) HYDRATED LIME 3%, 2) FLYASH 20%, 3) BOILER SLAS AGGREGATE 77%. POZ-O-PAC DENSITY 150.3 # PER CU. YD.
  - THE 1 FOOT LAYER OF POZ-O-PAC SHALL BE COMPACTED WITH 2-6" LIFTS UNTIL THE DESIRED DENSITY IS OBTAINED.
  - PRIOR TO THE INSTALLATION OF THE POZ-O-PAC, THE SUBBASE SHALL BE PREPARED BY UNDERCUTTING TO A MINIMUM OF 1 FOOT BELOW THE BOTTOM OF THE POZ-O-PAC FILLING WITH 2-6" LIFTS TO A COMPACTION OF 90% PROCTOR WITH CONSOLIDATION.

Sudhakar D Verma  
6/17/20

APPROVED FOR CONSTRUCTION  
6/17/20

DESIGNED BY	COMMONWEALTH EDISON COMPANY
CHECKED BY	WASTE WATER TREATMENT FACILITIES
DATE	JOLIET # 8
PROJECT NO.	5079C5019
CONTRACT NO.	5079C5019
REV.	2

NUS CORPORATION  
ROCKVILLE, MD.

9019 C 6209

5079C5106

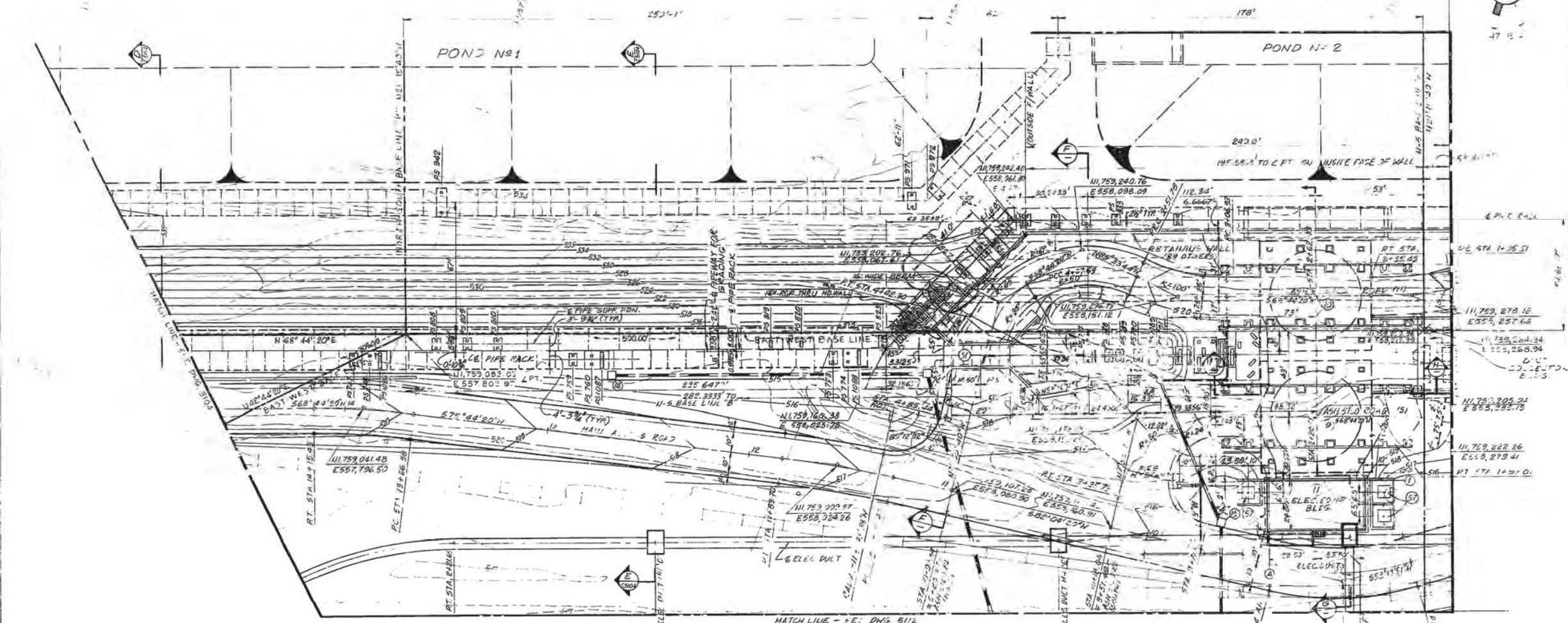

- 1. ADDED TRANSFORMER STRUCTURES. 57 UPDATED. ADDED RE HYDRANT LOCATION. 58 5' FT FUND. IN. IN. RELOCATED STORM DRAIN STRUCT. NO. 16. 59 IGA ADDED.
- 2. ADDED FOUNDATION #482 TO ASH SILOS FOR STRUCTURE STAB. DEFINED EMBANKMENT GRADING AT SAID P.S. STRUCTURES & AT 16-A.
- 3. ROTTED R.S.W. DRAIN LATERAL TO 16-A. CONTRACT NO. 5079-1008 & TO FACE HYDRANT.
- 4. REVISED FINISH GRADE ON 16-A BETWEEN 5526 & 5529 TO CORRELATE WITH DWG 5079-C5078.

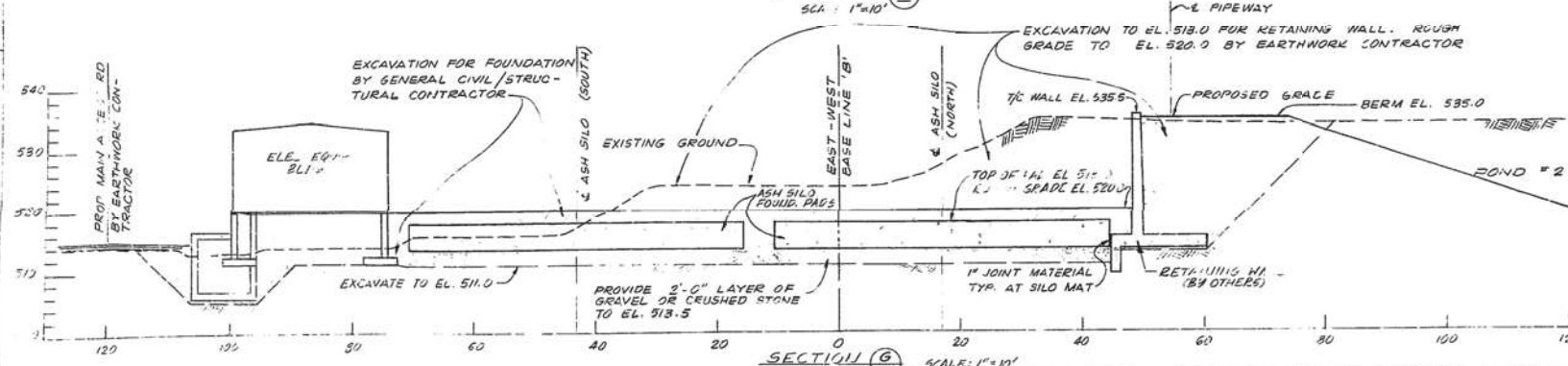
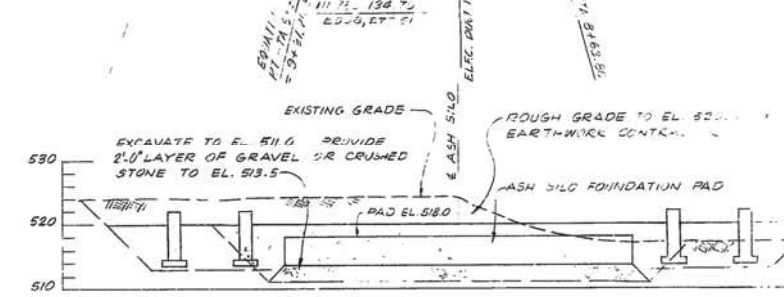
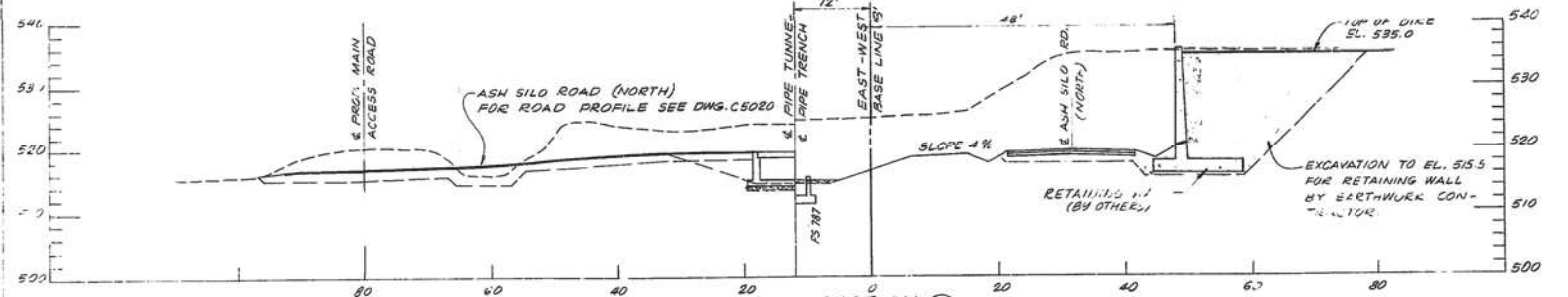

- NOTES:**
1. FOR LIST OF REF. DWGS. SEE DWG. C510.
  2. FOR 511.1. NOTE: SEE P.L. C5134.
  3. DRAWINGS C510, C513, C518 ARE NOT TO BE USED FOR LOCAT. OF PIPE STRUCTS.
- Sudhakar P. Verma  
11-17

**APPROVED FOR CONSTRUCTION**

COMMONWEALTH EDISON COMPANY  
WASTE WATER TREATMENT FACILITIES  
JOLIET 7 & 8  
**DETAIL PLAN**  
ASH SILO AREA

DESIGNED BY	DATE	SCALE
CHECKED BY	DATE	SCALE
APPROVED BY	DATE	SCALE
PROJECT NO.	DATE	SCALE

CECO CONTRACT: 803487  
NUS CORPORATION  
5079 C 51  
ROCKVILLE, MD



5079C5503

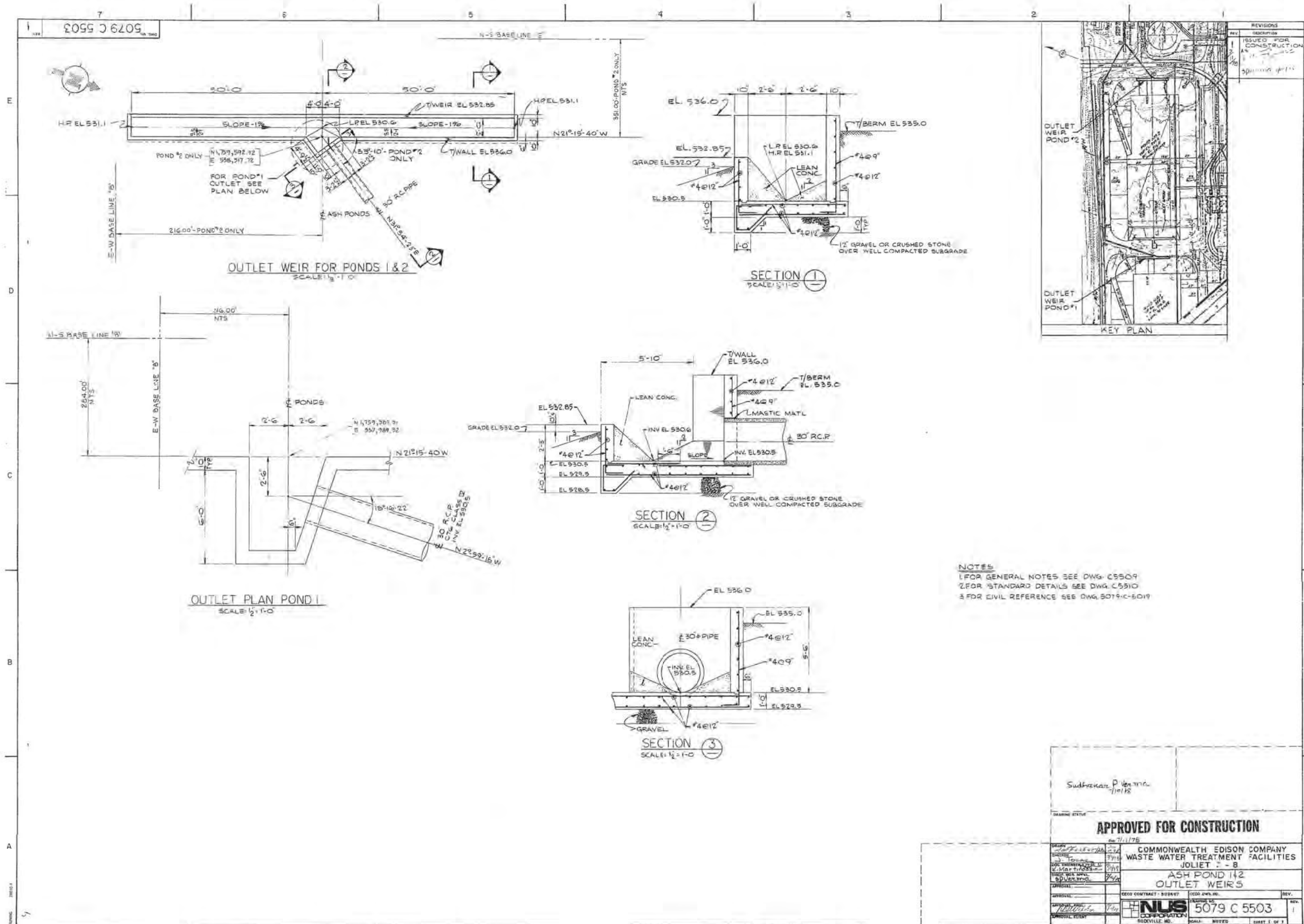

REV.	DESCRIPTION
1	ISSUED FOR CONSTRUCTION

Sudhakar P. Venkata 7/11/12	
<b>APPROVED FOR CONSTRUCTION</b>	
7/11/12	
COMMONWEALTH EDISON COMPANY WASTE WATER TREATMENT FACILITIES JOLIET - B	
ASH POND 142 OUTLET WEIRS	
DESIGNED BY: [Signature]	DATE: 7/11/12
CHECKED BY: [Signature]	DATE: 7/11/12
APPROVED BY: [Signature]	DATE: 7/11/12
CONTRACT NO.: 5079C	DWG. NO.: 5079 C 5503
<b>NUS CORPORATION</b>	
5079 C 5503	
SICVILLE, MD.	

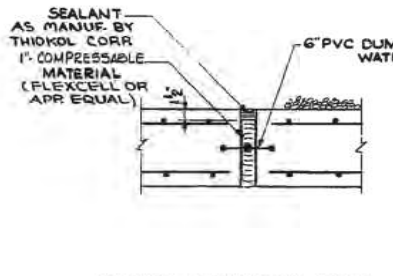
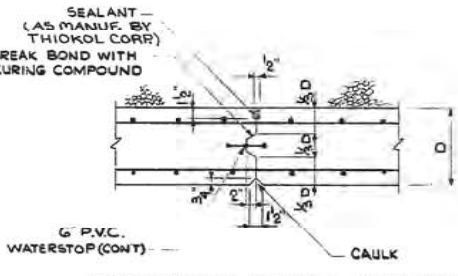
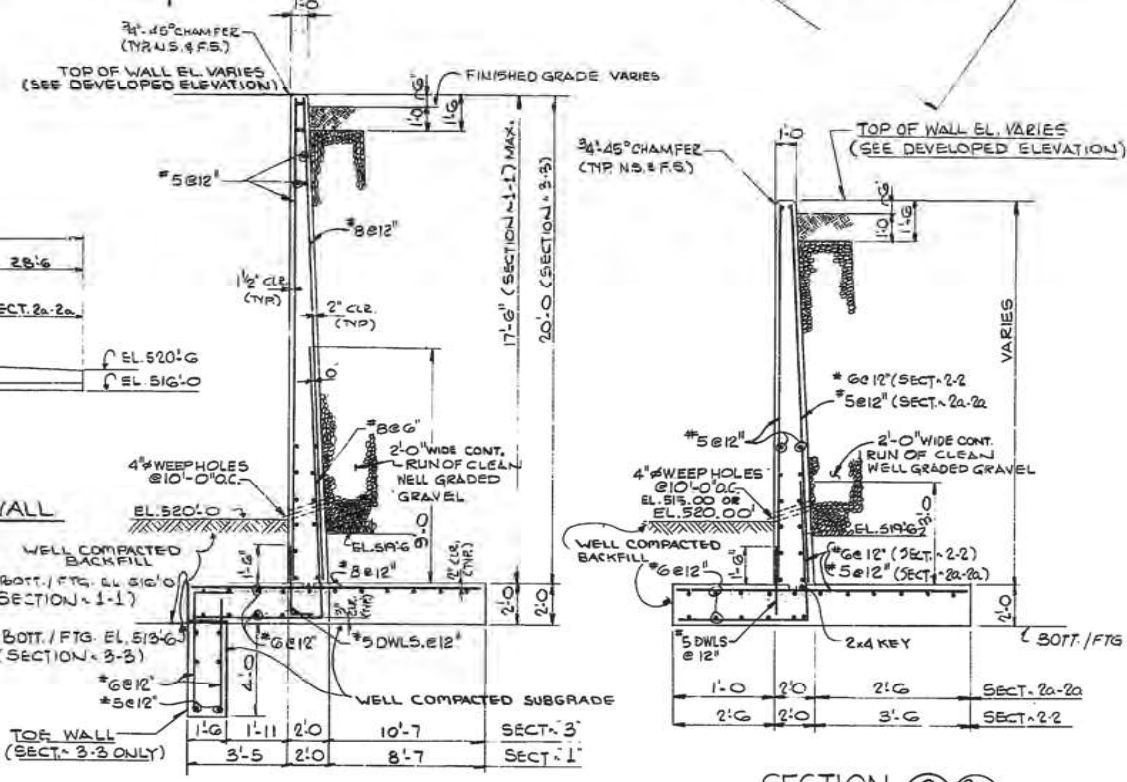
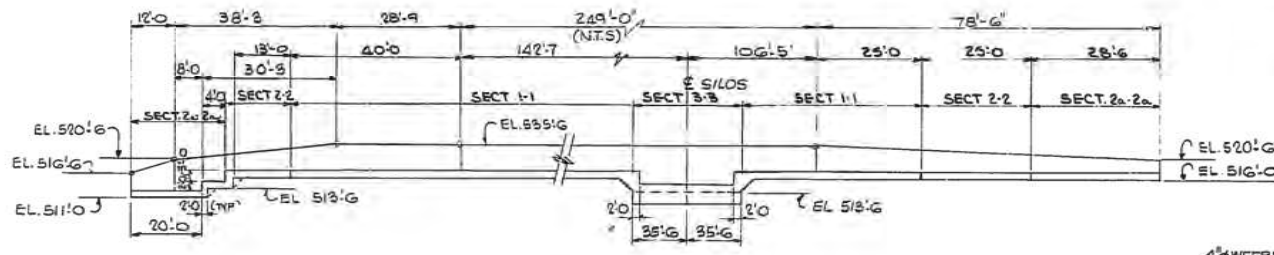
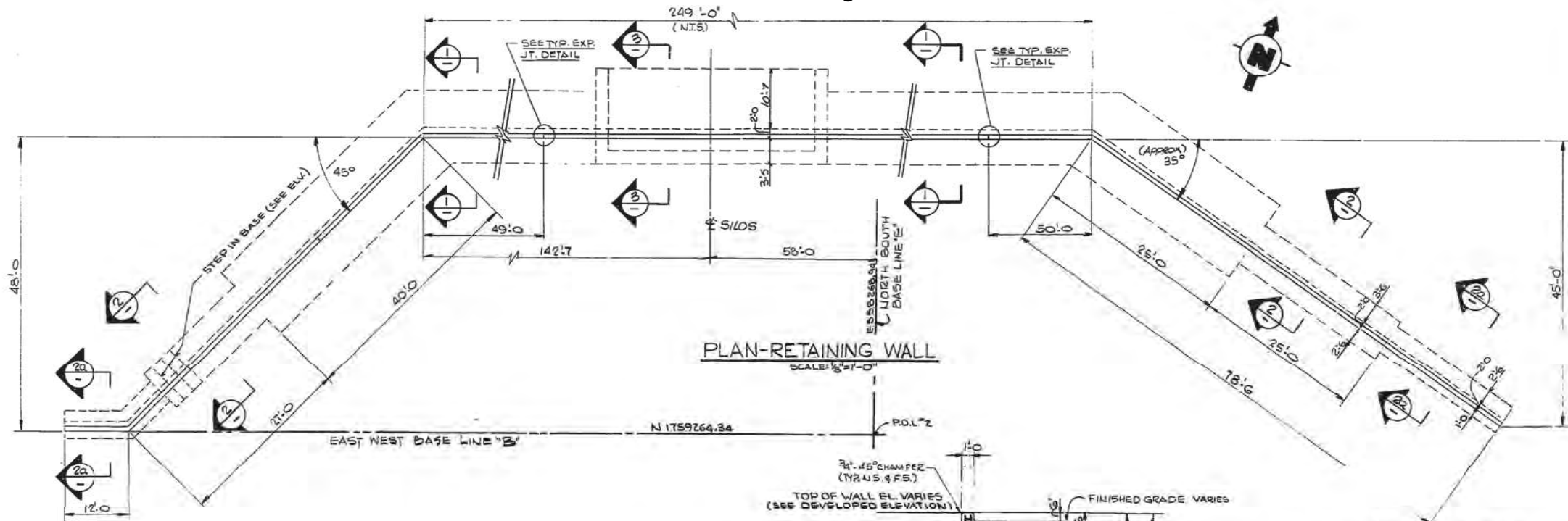
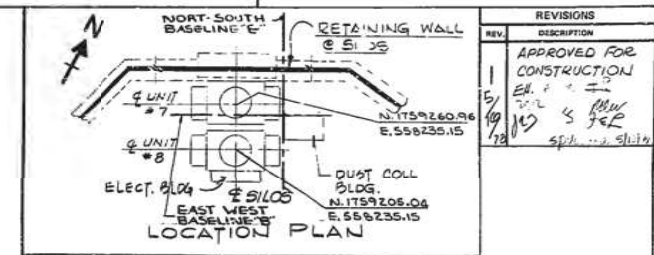

- GENERAL NOTES:
1. ALL CONCRETE SHALL HAVE MINIMUM COMPRESSIVE STRENGTH OF 4000 P.S.I. @ 28 DAYS. (TYPE OF CEMENT - I)
  2. ALL CONCRETE SHALL BE AIR-ENTRAINED.
  3. ALL REBARS SHALL CONFORM TO A.S.T.M. A-615 GRADE 60. (F<sub>y</sub> 60000 PSI)
  4. DESIGN SOIL BEARING PRESSURE - 5000 P.S.F.
  5. SOIL UNDERNEATH THE WALL SHALL BE WELL COMPACTED BEFORE PLACING OF CONCRETE.
  6. WORK THIS DWG WITH DWG. CS106 & CS107

NOTE:  
PROVIDE CONTROL JOINTS AT EVERY 40'-0"

APPROVED FOR CONSTRUCTION

COMMONWEALTH EDISON COMPANY  
WASTE WATER TREATMENT FACILITIES  
JOLIET 7&B

RETAINING WALL @ SILOS  
PLAN, SECTIONS & ELEVATION

CECO CONTRACT NO. 802557 | CECO DWG. NO.

**NUS CORPORATION**  
ROCKVILLE, MD.

5079-C-5507

SCALE: AS NOTED

5079 C 5103

5079C5103



FOR GENERAL NOTES SEE DRAWING 5079 C 5101.

**APPROVED FOR CONSTRUCTION**

DATE	1/22/13	COMMONWEALTH EDISON COMPANY WASTE WATER TREATMENT FACILITIES JOLIET - 5
PROJECT		SITE PLAN EAST YARD AREA
DESIGNED BY		
CHECKED BY		
APPROVED BY		
SCALE	AS SHOWN	
NUS CORPORATION		5079 C 5103
ROCKFORD, ILL.		

CONDITION OF ORIGINAL -FAIR- REPRODUCTION CONSULTANTS, LTD. 30X42







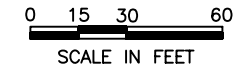
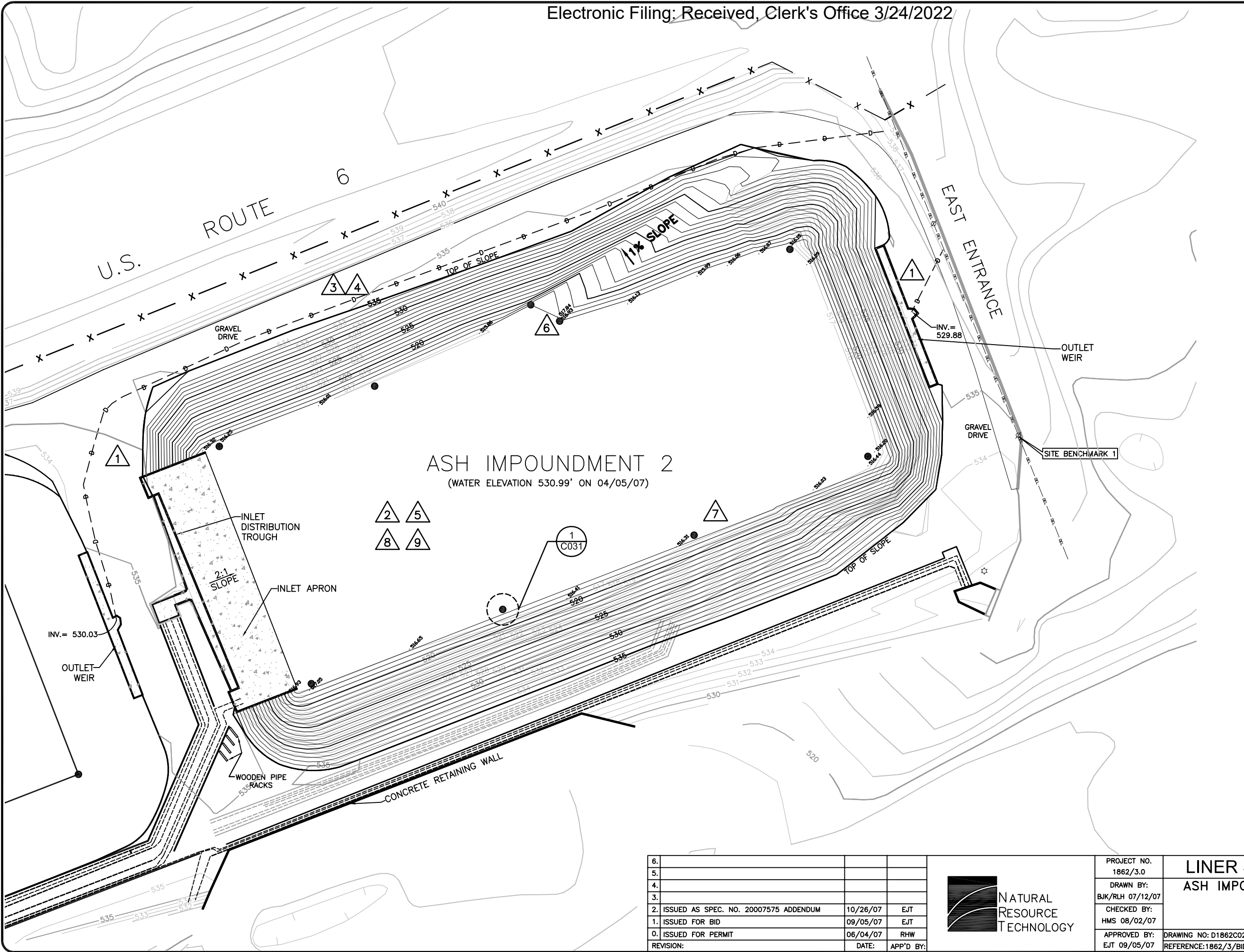

LEGEND	
	GROUND SURFACE CONTOURS
	PROPOSED SURFACE CONTOURS
	UNDERGROUND DISCHARGE PIPE
	FENCE
	EDGE OF PIPE RACK
	ABOVE GROUND PIPELINES
	OVERHEAD ELECTRIC LINE
	POWER POLE
	LIGHT POLE
	MARKER POST
	CONCRETE

- CONTRACTOR NOTES:**
- CONTRACTOR SHALL FIELD VERIFY LOCATION OF UNDERGROUND DISCHARGE PIPES WITH ASSISTANCE OF OWNER'S UTILITY LOCATOR.
  - PROTECT ALL CONCRETE AND UTILITY STRUCTURES THROUGHOUT PROJECT DURATION.
  - CONTRACTOR SHALL STORE ALL GEOSYNTHETICS AND SUBGRADE MATERIALS AT A LOCATION APPROVED BY OWNER AS DISCUSSED DURING PRE-BID MEETING.
  - CONTRACTOR SHALL STORE AND STAGE EQUIPMENT AT A LOCATION APPROVED BY THE OWNER.
  - CONTRACTOR SHALL REMOVE VEGETATION, ROCKS AND OTHER DEBRIS GREATER THAN 3 INCHES FROM IMPOUNDMENT SUBGRADE AND DISPOSE AT AN APPROVED FACILITY. SIDE SLOPES SHALL BE GRADED FLAT TO REMOVE EROSION RILLS.
  - CONTRACTOR SHALL REMOVE AT LEAST 18 INCHES OF EXISTING RAMP MATERIAL FOR PLACEMENT OF SUBGRADE LAYER AND FINAL LAYER OF RAMP. EXCAVATED RAMP MATERIAL SHALL BE REUSED AS FINAL LAYER OF RAMP AS INDICATED ON THIS SHEET.
  - CONTRACTOR SHALL INSTALL MARKER POSTS ALONG THE BASE OF THE IMPOUNDMENTS AS SHOWN AND IN ACCORDANCE WITH THE TECHNICAL SPECIFICATIONS AND DETAIL 1 ON SHEET C031.
  - CONTRACTOR SHALL PLACE 16 OZ. NON WOVEN GEOTEXTILE OVER THE PREPARED SUBGRADE IN ACCORDANCE WITH THE TECHNICAL SPECIFICATIONS AND AS APPROVED BY GEOMEMBRANE INSTALLER PRIOR TO INSTALLATION OF GEOMEMBRANE.
  - CONTRACTOR SHALL PROVIDE MEANS TO PROTECT 16-OZ. NON WOVEN GEOTEXTILE FROM POTENTIAL DAMAGE. DAMAGE TO GEOTEXTILE SHALL BE REPAIRED AT THE CONTRACTOR'S EXPENSE.

**SOURCE NOTES:**

- THIS DRAWING WAS DEVELOPED FROM A SURVEY MAP BY BENTON, TRULL & ASSOCIATES, INC., JOLIET, ILLINOIS, FILED IN THE TOPOGRAPHY OF MICHIGAN GENERATION JOLIET 20 POWER PLANT ASH IMPOUNDMENTS, SHEET 1 OF 1, DATED APRIL 21, 2007, FILE NO. 0407-2007. COORDINATE SYSTEM IS ILLINOIS STATE PLANE EAST ZONE, DATUM 1983.
- ASH IMPOUNDMENTS 1 AND 2 WERE DEVELOPED FROM SURVEYS BY BENTON, TRULL & ASSOCIATES, INC., JOLIET, ILLINOIS, FILED IN THE TOPOGRAPHY OF MICHIGAN GENERATION JOLIET 20 POWER PLANT ASH IMPOUNDMENTS, SHEET 1 OF 1, DATED APRIL 21, 2007, FILE NO. 0407-2007. COORDINATE SYSTEM IS ILLINOIS STATE PLANE EAST ZONE, DATUM 1983.
- PROPOSED CURVE OF ASH IMPOUNDMENTS 1 AND 2 WAS DEVELOPED FROM SURVEYS BY BENTON, TRULL & ASSOCIATES, INC., JOLIET, ILLINOIS, FILED IN THE TOPOGRAPHY OF MICHIGAN GENERATION JOLIET 20 POWER PLANT ASH IMPOUNDMENTS, SHEET 1 OF 1, DATED APRIL 21, 2007, FILE NO. 0407-2007. COORDINATE SYSTEM IS ILLINOIS STATE PLANE EAST ZONE, DATUM 1983.
- GROUND SURFACE CONTOURS WERE DERIVED FROM A SURVEY MAP BY BENTON, TRULL & ASSOCIATES, INC., JOLIET, ILLINOIS, FILED IN THE TOPOGRAPHY OF MICHIGAN GENERATION JOLIET 20 POWER PLANT ASH IMPOUNDMENTS, SHEET 1 OF 1, DATED OCTOBER 26, 2007, FILE NO. 0407-2007.

**ASH IMPOUNDMENT 2**  
(WATER ELEVATION 530.99' ON 04/05/07)

**NOT FOR CONSTRUCTION**

6.			
5.			
4.			
3.			
2.	ISSUED AS SPEC. NO. 20007575 ADDENDUM	10/26/07	EJT
1.	ISSUED FOR BID	09/05/07	EJT
0.	ISSUED FOR PERMIT	06/04/07	RHW
REVISION:		DATE:	APP'D BY:



PROJECT NO.	1862/3.0
DRAWN BY:	BJK/RLH 07/12/07
CHECKED BY:	HMS 08/02/07
APPROVED BY:	EJT 09/05/07

<b>LINER SUBGRADE PREPARATION</b>	
<b>ASH IMPOUNDMENT #2 LINER REPLACEMENT</b>	
<b>MICHIGAN GENERATION</b>	
<b>JOLIET STATION NO. 29</b>	
<b>JOLIET, ILLINOIS</b>	
DRAWING NO: D1862C020-02	SHEET NO. C020
REFERENCE: 1862/3/BID-CON/	

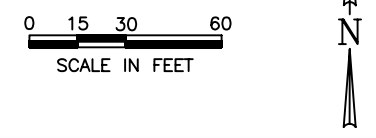
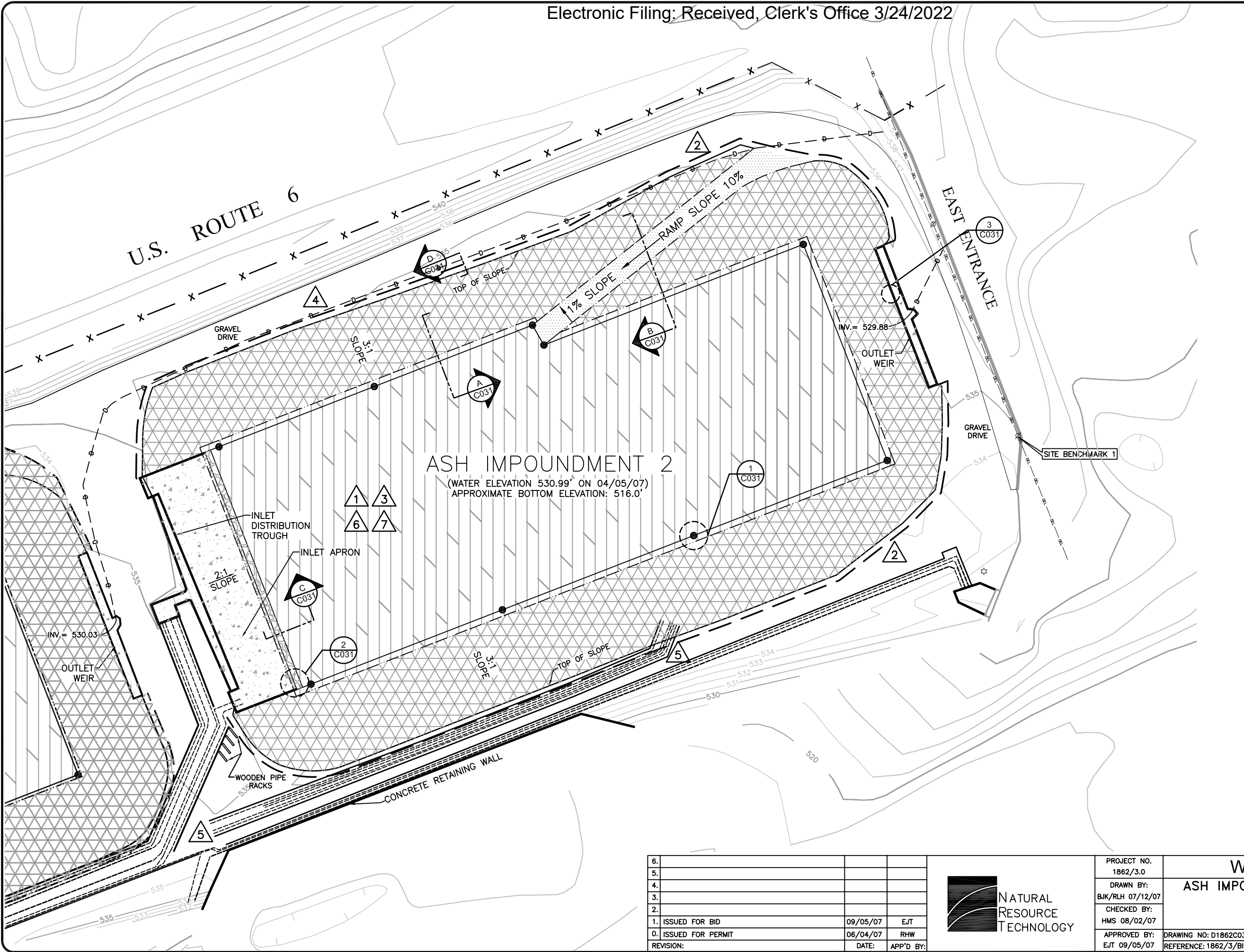

**LEGEND**

	GROUND SURFACE CONTOURS
	UNDERGROUND DISCHARGE PIPE
	FENCE
	EDGE OF PIPE RACK
	ABOVE GROUND PIPELINES
	OVERHEAD ELECTRIC LINE
	POWER POLE
	LIGHT POLE
	MARKER POST
	ANCHOR TRENCH
	12 OZ. NON-WOVEN GEOTEXTILE
	CONCRETE
	EXCAVATED RAMP MATERIAL
	RIP RAP
	WARNING LAYER
	HDPE GEOMEMBRANE

**CONTRACTOR NOTES:**

- CONTRACTOR SHALL INSTALL 60 MIL HDPE, WHITE, TEXTURED GEOMEMBRANE IN ACCORDANCE WITH THE TECHNICAL SPECIFICATION PRIOR TO PLACEMENT OF THE WARNING LAYER. CONTRACTOR SHALL PROVIDE AND FOLLOW AN APPROVED GEOMEMBRANE LAYOUT PLAN.
- GEOMEMBRANE SHALL BE ANCHORED INTO 2.5 FEET DEEP TRENCHES ALONG TOP OF IMPOUNDMENT BANK, AS SHOWN IN SECTION D ON SHEET C031. CONTRACTOR SHALL ADVISE OWNER AND/OR ENGINEER IF PROPOSED LOCATION NOT POSSIBLE. DISCHARGE PIPE SHALL BE FIELD LOCATED AND CONTRACTOR SHALL NOTIFY OWNER IF ANCHOR TRENCH INTERFERES WITH PIPING.
- CONTRACTOR SHALL PLACE 12-OZ. NON-WOVEN GEOTEXTILE OVER THE GEOMEMBRANE, SAND MATERIAL AND WARNING LAYER MATERIAL AT BASE AND 4 FEET ON SIDE SLOPES AFTER RECEIVING APPROVAL FROM ENGINEER AND PASSING QUALITY CONTROL RESULTS IN ACCORDANCE WITH TECHNICAL SPECIFICATIONS. (SEE SHEET C031)
- RESTORE AREAS DISTURBED BY EQUIPMENT AND MATERIAL LAYDOWN.
- ABOVE GROUND PIPING TO BE INSTALLED BY OTHERS.
- CONTRACTOR SHALL PROVIDE SURVEY DOCUMENTATION OF THE ITEMS LISTED IN THE TECHNICAL SPECIFICATIONS.
- CONTRACTOR SHALL PERFORM A LEAK LOCATION SURVEY IN ACCORDANCE WITH TECHNICAL SPECIFICATIONS.

**SOURCE NOTES:**

- THIS DRAWING WAS DEVELOPED FROM A SURVEY MAP BY BENTLEY, TOWELL & ASSOCIATES, INC., DATED APRIL 1967, PART OF SURVEY TOPOGRAPHY OF JOLIET GENERATION UNIT 29 POWER PLANT AND IMPOUNDMENTS, SHEET 1 OF 1, PAGES 7, 8, 9, 10, 11, 12, 13, 14, 15, 16, 17, 18, 19, 20, 21, 22, 23, 24, 25, 26, 27, 28, 29, 30, 31, 32, 33, 34, 35, 36, 37, 38, 39, 40, 41, 42, 43, 44, 45, 46, 47, 48, 49, 50, 51, 52, 53, 54, 55, 56, 57, 58, 59, 60, 61, 62, 63, 64, 65, 66, 67, 68, 69, 70, 71, 72, 73, 74, 75, 76, 77, 78, 79, 80, 81, 82, 83, 84, 85, 86, 87, 88, 89, 90, 91, 92, 93, 94, 95, 96, 97, 98, 99, 100.
- ASH IMPOUNDMENTS 1 AND 2 WERE DEVELOPED FROM DRAWINGS BY BENTLEY, TOWELL & ASSOCIATES, INC., DATED APRIL 1967, PART OF SURVEY TOPOGRAPHY OF JOLIET GENERATION UNIT 29 POWER PLANT AND IMPOUNDMENTS, SHEET 1 OF 1, PAGES 7, 8, 9, 10, 11, 12, 13, 14, 15, 16, 17, 18, 19, 20, 21, 22, 23, 24, 25, 26, 27, 28, 29, 30, 31, 32, 33, 34, 35, 36, 37, 38, 39, 40, 41, 42, 43, 44, 45, 46, 47, 48, 49, 50, 51, 52, 53, 54, 55, 56, 57, 58, 59, 60, 61, 62, 63, 64, 65, 66, 67, 68, 69, 70, 71, 72, 73, 74, 75, 76, 77, 78, 79, 80, 81, 82, 83, 84, 85, 86, 87, 88, 89, 90, 91, 92, 93, 94, 95, 96, 97, 98, 99, 100.
- TOPOGRAPHY OF JOLIET GENERATION UNIT 29 POWER PLANT AND IMPOUNDMENTS, SHEET 1 OF 1, PAGES 7, 8, 9, 10, 11, 12, 13, 14, 15, 16, 17, 18, 19, 20, 21, 22, 23, 24, 25, 26, 27, 28, 29, 30, 31, 32, 33, 34, 35, 36, 37, 38, 39, 40, 41, 42, 43, 44, 45, 46, 47, 48, 49, 50, 51, 52, 53, 54, 55, 56, 57, 58, 59, 60, 61, 62, 63, 64, 65, 66, 67, 68, 69, 70, 71, 72, 73, 74, 75, 76, 77, 78, 79, 80, 81, 82, 83, 84, 85, 86, 87, 88, 89, 90, 91, 92, 93, 94, 95, 96, 97, 98, 99, 100.

**NOT FOR CONSTRUCTION**  
**WARNING LAYER PLAN**

6.			
5.			
4.			
3.			
2.			
1.	ISSUED FOR BID	09/05/07	EJT
0.	ISSUED FOR PERMIT	06/04/07	RHW
REVISION:		DATE:	APP'D BY:



PROJECT NO. 1862/3.0	<b>ASH IMPOUNDMENT #2 LINER REPLACEMENT MIDWEST GENERATION JOLIET STATION NO. 29 JOLIET, ILLINOIS</b>	SHEET NO. C030
DRAWN BY: BJK/RLH 07/12/07		
CHECKED BY: HMS 08/02/07	DRAWING NO: D1862C030-01	
APPROVED BY: EJT 09/05/07	REFERENCE: 1862/3/BID-CON/	

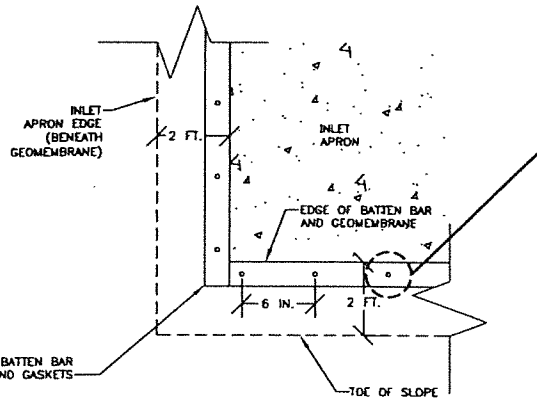
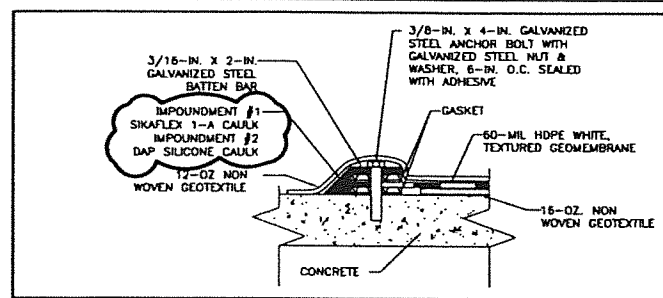

**2** INLET APRON DETAIL PLAN  
C030 NOT TO SCALE

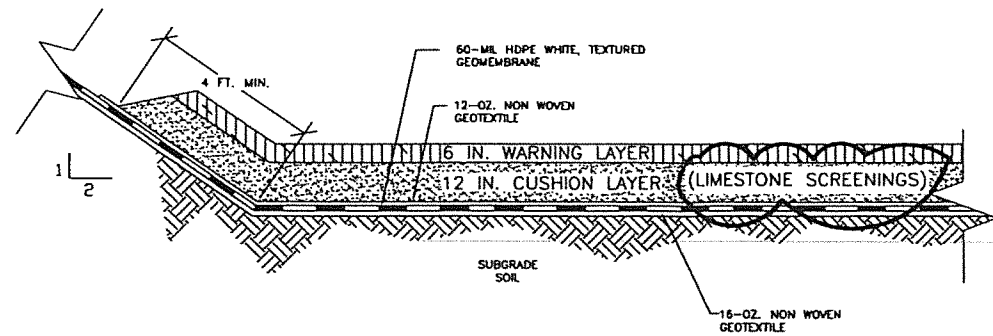

NOTE:  
1. GEOMEMBRANE SEAMS SHALL BE PLACED 2 TO 5 FT. FROM TOE OF SLOPE AT A MINIMUM.

**A** SLOPE TRANSITION SECTION  
C030 NOT TO SCALE

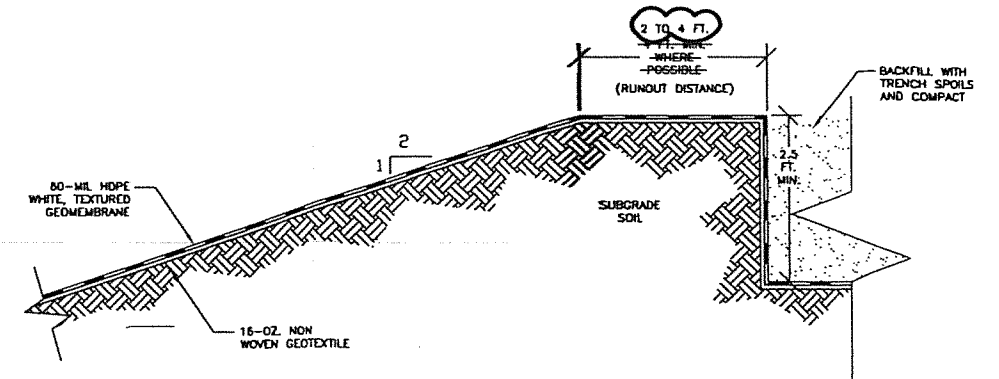

**D** ANCHOR TRENCH SECTION  
C030 NOT TO SCALE

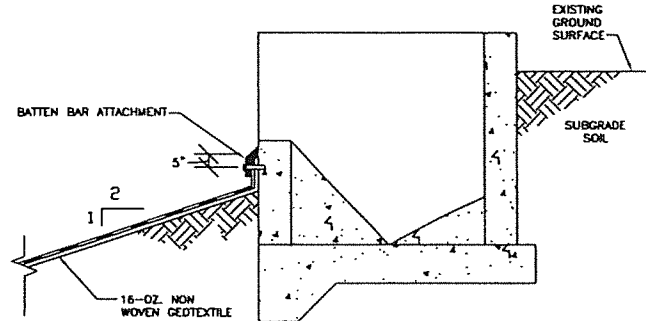

NOTE:  
1. REFER TO DETAIL 2 FOR BATTEN BAR ATTACHMENT. EXCLUDE USE OF THE TOP LAYER OF 12-OZ. NON WOVEN GEOTEXTILE.

**3** OUTLET WEIR DETAIL  
C030 NOT TO SCALE

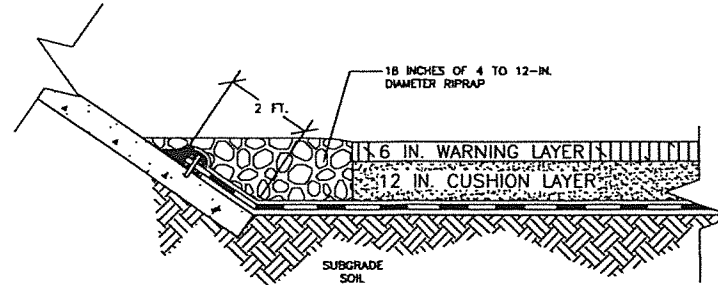

NOTE:  
1. REFER TO DETAIL 2 FOR BATTEN BAR ATTACHMENT.

**C** INLET APRON SECTION  
NOT TO SCALE

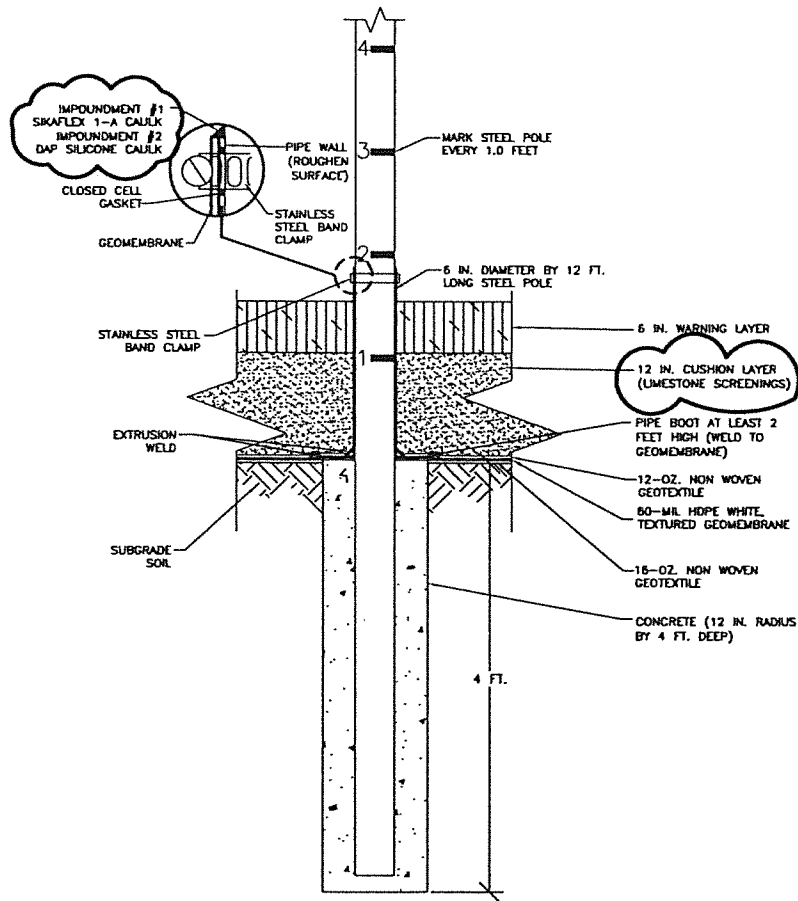

**1** MARKER POST DETAIL  
C020 NOT TO SCALE

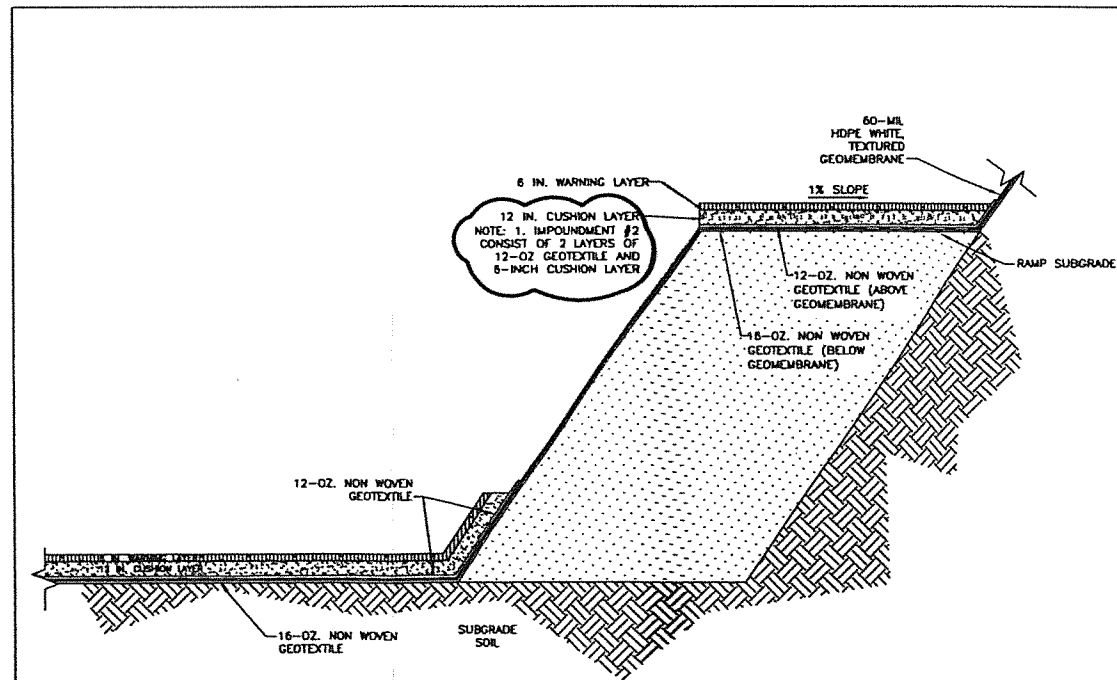

**B** RAMP SECTION  
C030 NOT TO SCALE

6.			
5.			
4.			
3.			
2.			
1.			
0.	RECORD DRAWING	12/19/08	HMS
REVISION:		DATE:	APP'D BY:



PROJECT NO.	1862/5.2
DRAWN BY:	KNW 12/19/08
CHECKED BY:	HMS 12/19/08
APPROVED BY:	HMS 12/19/08

<b>DETAILS AND SECTIONS</b>	
ASH IMPOUNDMENT #1 AND #2 LINER REPLACEMENT	
MIDWEST GENERATION, LLC	
JOLIET STATION NO. 29	
JOLIET, ILLINOIS	
DRAWING NO: D1862C031-00	SHEET NO. C031
REFERENCE: 1862/RECORD DWGS/	

# **ATTACHMENT 5**



# ASBUILT OF MIDWEST GENERATION JOLIET 29 POWER PLANT WEST-ASH IMPOUNDMENTS

### NOTES:

1. PDF ANNOTATIONS BY THOMAS J. DEHLIN ON MARCH 18, 2022.
2. CUT / FILL AREAS BASED ON NOTABLE CHANGES IDENTIFIED BETWEEN TOPOGRAPHIC MAP OF PRE-LINED POND 2 (DATED 10/20/2007) AND THIS TOPOGRAPHIC MAP OF THE AS-LINED POND 2 (DATED 12/02/2008). ALL AREAS ARE APPROXIMATE.

APPROXIMATE "CUT" AREA TO REGRADE AND / OR SMOOTH INTERIOR SIDE SLOPE PRIOR TO INSTALLING HDPE GEOMEMBRANE LINER

APPROXIMATE "CUT" AREA TO REGRADE AND / OR SMOOTH INTERIOR SIDE SLOPE PRIOR TO INSTALLING HDPE GEOMEMBRANE LINER

APPROXIMATE "FILL" AREA TO REGRADE AND / OR SMOOTH INTERIOR SIDE SLOPE PRIOR TO INSTALLING HDPE GEOMEMBRANE LINER

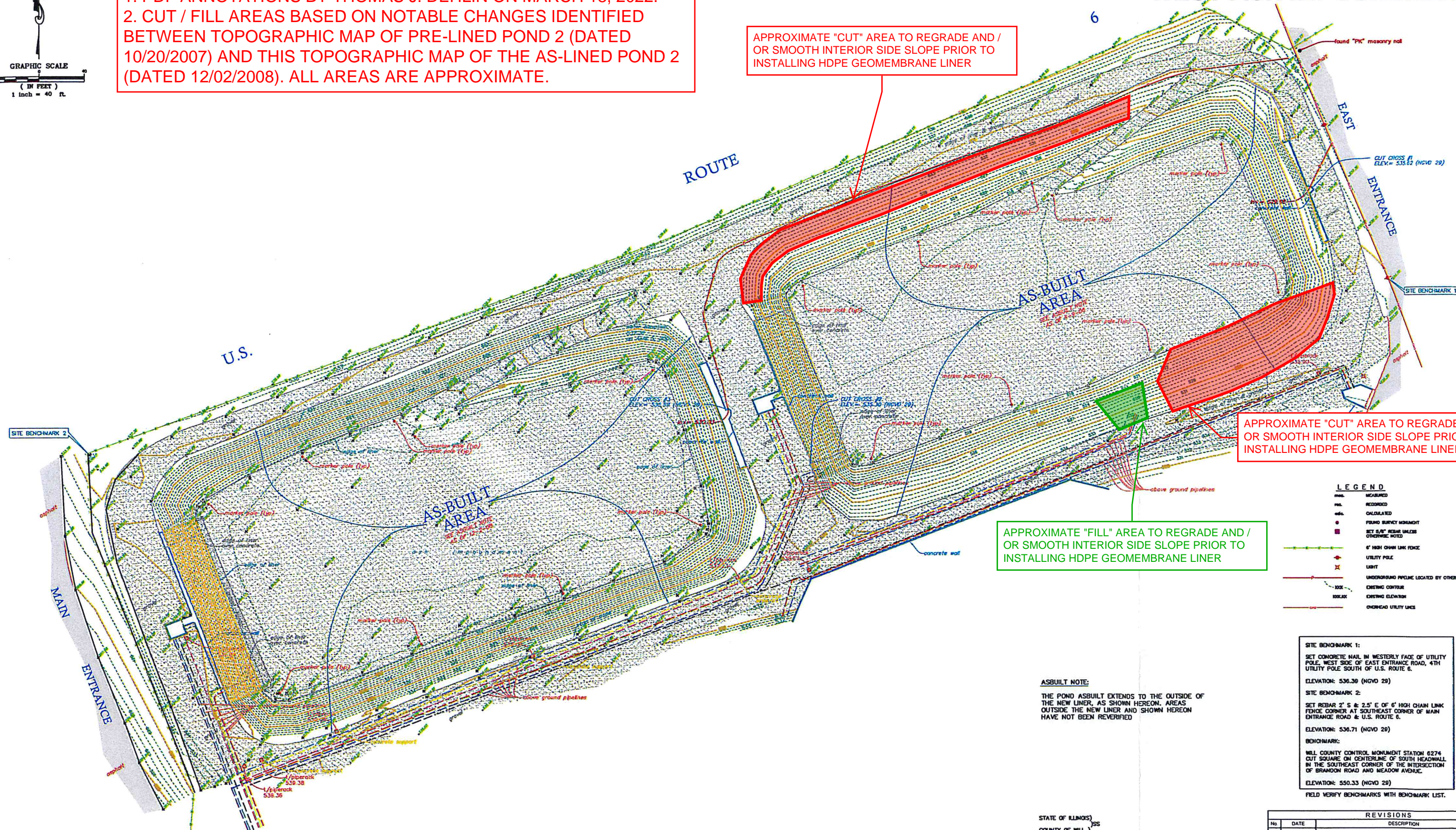
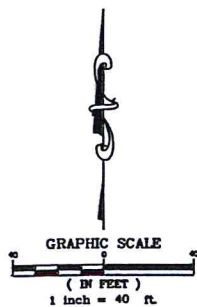

**LEGEND**

- meas. MEASURED
- rec. RECORDED
- calc. CALCULATED
- FOUND SURVEY MONUMENT
- SET 5/8" REBAR UNLESS OTHERWISE NOTED
- 6" HIGH CHAIN LINK FENCE
- UTILITY POLE
- LIGHT
- UNDERGROUND PIPELINE LOCATED BY OTHERS
- EXISTING CONTOUR
- EXISTING ELEVATION
- OVERHEAD UTILITY LINES

### ASBUILT NOTE:

THE POND ASBUILT EXTENDS TO THE OUTSIDE OF THE NEW LINER, AS SHOWN HEREON. AREAS OUTSIDE THE NEW LINER AND SHOWN HEREON HAVE NOT BEEN REVERIFIED

**SITE BENCHMARK 1:**  
SET CONCRETE NAIL IN WESTERLY FACE OF UTILITY POLE, WEST SIDE OF EAST ENTRANCE ROAD, 4TH UTILITY POLE SOUTH OF U.S. ROUTE 6.  
ELEVATION: 536.39 (NGVD 29)

**SITE BENCHMARK 2:**  
SET REBAR 2" S & 2.5' E OF 6" HIGH CHAIN LINK FENCE CORNER AT SOUTHEAST CORNER OF MAIN ENTRANCE ROAD & U.S. ROUTE 6.  
ELEVATION: 536.71 (NGVD 29)

**BENCHMARK:**  
MILL COUNTY CONTROL MONUMENT STATION 8274 CUT SQUARE ON CENTERLINE OF SOUTH HEADWALL IN THE SOUTHEAST CORNER OF THE INTERSECTION OF BRANDON ROAD AND MEADOW AVENUE.  
ELEVATION: 550.33 (NGVD 29)

FIELD VERIFY BENCHMARKS WITH BENCHMARK LIST.

STATE OF ILLINOIS )  
COUNTY OF WILL )

RUETTIGER, TONELLI & ASSOCIATES, INC., ILLINOIS PROFESSIONAL DESIGN FIRM No. 194-001251, HEREBY CERTIFIES THAT IT HAS TOPOGRAPHICALLY SURVEYED THE POND AREA NOTED HEREON AND AS SHOWN ON THE ANNEXED PLAN, WHICH IS A TRUE AND CORRECT REPRESENTATION OF SAID TOPOGRAPHY.

SURVEY FIELD WORK COMPLETED 10/20/08  
GIVEN UNDER MY HAND AND SEAL THIS 10th DAY OF MAY, 2008.

BY \_\_\_\_\_  
ILLINOIS PROFESSIONAL LAND SURVEYOR (BY USORR EXEMPT 11-30-2006)

REVISIONS			
NO	DATE	DESCRIPTION	BY
1	12/2/08	ADDED NEW ASBUILT INFORMATION	MJ

**RT & A** **Ruettiger, Tonelli & Associates, Inc.**  
Surveyors • Engineers • Planners • Landscape Architects • G.E.S. Consultants  
2174 ONEIDA STREET JOLIET, ILLINOIS 60435 2603 S. WASHINGTON STREET - SUITE 170 NAPERVILLE, ILLINOIS 60563  
TEL: (815) 244-6600 FAX: (815) 244-0101 TEL: (630) 430-7740 FAX: (630) 430-7741

DATE: 6/9/08 SCALE: 1" = 40' DRAWN BY: MJJ CHECKED BY: EC  
PREPARED FOR: BREXER CONSTRUCTION COMPANY 24101 S. MUNICIPAL DRIVE CHANNAHON, IL FIELD BOOK: MIDWEST GEN PAGE: 11-13  
DRAWING No.: 308-4363 ASBUILT WEST-ASH IMP.

ANY DISCREPANCY IN MEASUREMENT OBTAINED UPON THE DRAWING SHOULD BE REPORTED IMMEDIATELY TO THE SURVEYOR FOR CLARIFICATION OR CORRECTION.

FOR BLINDING LINES AND OTHER ANNOTATIONS NOT SHOWN HEREON REFER TO THESE ARCHITECT, ENGINEER, CONTRACTOR AND OTHER DOCUMENTS.



# **ATTACHMENT 6**

WATER N6B1

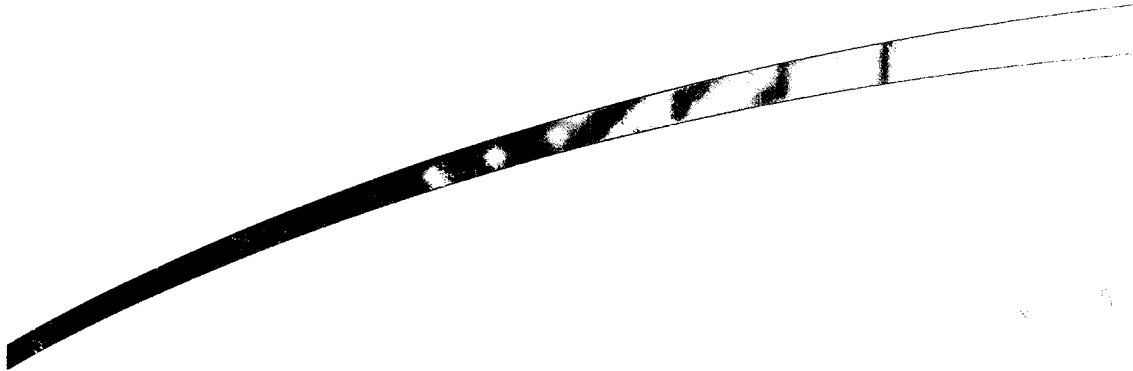

**MIDWEST  
GENERATION™**

AN ILLINOIS ENERGY SERVICES COMPANY

# **Technical Specifications for Ash Impoundment #2 Liner Replacement**

**Joliet 29 Generation Station  
1800 Channahon Road  
Joliet, Illinois**

**August 3, 2007**

**Project No: 1862**





**MIDWEST  
GENERATION**

AN ILLINOIS POWER & LIGHT COMPANY

# **Technical Specifications for Ash Impoundment #2 Liner Replacement**

**Joliet 29 Generation Station  
1800 Channahon Road  
Joliet, Illinois**

**August 3, 2007**

**Project No: 1862**



# TRANSMITTAL

www.naturalrt.com

<b>To:</b>	<b>Midwest Generation, LLC</b>	<b>Date:</b>	<b>August 3, 2007</b>
	<b>Joliet 29 Station</b>	<b>Project #:</b>	<b>1862</b>
	<b>1800 Channahon Road</b>	<b>From:</b>	<b>Eric Tlachac</b>
	<b>Joliet, IL 60436</b>		
<b>Attn:</b>	<b>Elsie Briette</b>	<b>Direct No:</b>	<b>262-522-1214</b>
<b>Cc:</b>	<b>Len Johnson, Midwest Generation</b>		
<b>Re:</b>	<b>Draft Specifications and Drawings for Ash Impoundment #2 Liner Replacement</b>		

For Your Files  As Requested  For Review  Approve & Return

<u>Copies:</u>	<u>Description</u>
1	Draft Technical Specifications for Ash Impoundment #2 Liner Replacement, Midwest Generation Joliet 29 Station, 1800 Channahon Road, Joliet, Illinois.

**Message:**

Please find enclosed draft technical specifications and drawings for the replacement liner for Ash Impoundment #2 at the Joliet 29 Station. Please review and contact me with your comments. Following receipt of your comments, we will finalize the technical specifications and drawings, and send you an adequate number of copies to include in your Request For Proposal for the project.

Thanks for the opportunity to provide continued support to Midwest Generation on this project.



**DRAFT**

**(DRAFT)  
TECHNICAL SPECIFICATIONS FOR  
ASH IMPOUNDMENT #2 LINER REPLACEMENT**

**JOLIET 29 GENERATION STATION  
1800 CHANNANHON ROAD  
JOLIET, ILLINOIS**

**Project No. 1862**

**Prepared For:**

**Midwest Generation, LLC  
1800 Channahon Road  
Joliet, Illinois**

**Prepared By:**

**Natural Resource Technology, Inc.  
23713 West Paul Road, Suite D  
Pewaukee, WI 53072**

**August 3, 2007**

\_\_\_\_\_  
**Signature**

\_\_\_\_\_  
**(Seal)**

\_\_\_\_\_  
**Signature**

\_\_\_\_\_  
**(Seal)**

## TABLE OF CONTENTS

---

### INTRODUCTORY PAGE

Section 00001 – Specification Data Sheet .....	00001-1 to 1
--	--------------

### DIVISION 1 - GENERAL REQUIREMENTS

Section 01010 – Summary of Work .....	01010-1 to 3
Section 01015 – General Requirements .....	01015-1 to 3
Section 01040 – Project Administration .....	01040-1 to 5
Section 01050 – Field Engineering and Surveying .....	01050-1 to 2
Section 01300 – Submittals .....	01300-1 to 2
Section 01400 – Quality Assurance and Control .....	01400-1 to 2
Section 01500 – Construction Facilities and Temporary Controls.....	01500-1 to 7
Section 01700 – Project Closeout .....	01700-1 to 2

### DIVISION 2 - SITE WORK

Section 02300 – Earthwork .....	02300-1 to 11
Section 02600 – HDPE Geomembrane .....	02600-1 to 19

### FIGURES

Figure 1	Site Location Map (1862-A01C)
----------	-------------------------------

### TABLES

Table 1	List of Documentation Surveys
Table 2	List of Submittals

### SHEETS

TS	Title Sheet (D1862-TS-00)
C010	Existing Conditions (D1862 C010-01)
C020	Liner Subgrade Preparation (D1862 C020-01)
C030	Warning Layer Plan (D1862 C030-01)
C031	Details and Sections (D1743 C031-01)

**SECTION 00001  
SPECIFICATION DATA SHEET**

---

INTRODUCTORY PAGE

SPECIFICATION TITLE: Ash Impoundment #2 Liner Replacement  
Midwest Generation, LLC Joliet 29 Generation Station  
Joliet, Illinois

REVISION NO.: 0

DATE: August 1, 2007

MIDWEST GENERATION  
PROJECT MANAGER: Elsie Briette- (815) 207-5489

NATURAL RESOURCE  
TECHNOLOGY, INC. (NRT)  
ENGINEERS: Eric J. Tlachac, PE – Project Manager-(262) 522-1214  
Heather M. Simon, PE – Project Engineer-(262) 522-1207

DESCRIPTION OF WORK SUMMARY:

Replacement of liner in Ash Impoundment #2 at Joliet 29 Generation Station in Joliet, Illinois. Site activities will consist of subgrade preparation, including minimal grading, excavation, transport, stockpiling and disposal, installation of marker posts, excavation of anchor trench, installation of white, 60-mil HDPE geomembrane and surrounding geotextile, placement of warning layer material, ramp reconstruction, and leak location survey of geomembrane.

**END OF SECTION**

**DIVISION I**

**DIVISION 1**  
**GENERAL REQUIREMENTS**



**SECTION 01010  
SUMMARY OF WORK**

---

**PART 1 - GENERAL**

1.01 SECTION INCLUDES

- A. Definitions
- B. Location of Project
- C. Existing Site Conditions and Uses
- D. Work by Contractor
- E. Work by Owner
- F. Work by Others

1.02 DEFINITIONS

- A. Owner: Midwest Generation, LLC.
- B. Engineer: Natural Resource Technology, Inc. (NRT).
- C. Contractor: The Contractor performing the Work described herein.
- D. Contract Drawings: Set of construction drawings titled, "Ash Impoundment #2 Liner Replacement, Midwest Generation, Joliet Station No. 29, Joliet, Illinois."
- E. Specifications: Exhibit A – Technical specifications of which this is the first Section.
- F. Work: All labor, supplies, and materials for completing liner construction, as shown and specified.

1.03 LOCATION OF PROJECT

- A. The project is located at Ash Impoundment #2 at the Joliet Station No. 29 in Joliet, Illinois.
- B. Site is easily accessible by truck but security clearance is required for access. All contractor personnel must sign in at gate house.

## 1.04 EXISTING SITE CONDITIONS AND USES

- A. Ash Impoundments #1 and #2 both receive wastewater from the plant and individually discharge to Ash Impoundment #3 (east of the plant East Entrance, not shown on Contract Drawings). They operate in parallel to one another with only one impoundment in service at any given time. Currently, Ash Impoundment #1 is operating. Ash Impoundment #2 is not operating and undergoing fly ash removal. The condition of the current liner is unknown. The base of the impoundment is approximately 19 feet from the top bank. Ash fine deposits are distributed throughout the base of the impoundment. The total approximate volume of the impoundment is 14.5 million gallons.
- B. The Illinois Environmental Protection Agency (IEPA) is reviewing the Water Pollution Control Construction Permit Application for the project.
- C. Access to the Site will be provided at the Main Entrance.
- D. Overhead and underground utilities are present at the site.

## 1.05 WORK BY CONTRACTOR:

- A. The Contractor shall perform the following Work:
  - 1. Furnish all labor, materials, services, equipment, and perform all necessary work for the excavating, loading, and hauling of brush and excess material from Ash Impoundment #2 to an approved recycling/disposal facility; construction of geomembrane anchor trench; installation of geomembrane liner; excavating, stockpiling, loading, and hauling ramp material to an Owner approved location; and transporting and placing imported soil at the site; quality control activities including leak location survey; documentation surveys; and completing site restoration activities as indicated on the Contract Drawings and as specified herein.
- B. It shall be the Contractor's responsibility to obtain complete information as to the work involved in the project in order to submit a complete and comprehensive bid. Under no circumstances, shall the Contractor make any claims for any additional expenses incurred due to his failure to obtain a complete understanding of the complete and detailed scope of work involved during the bid period, after award, or after the Work is in progress. The summary of work described above is an overall summary of work to be performed and is the responsibility of the Contractor. It does not supersede specific requirements of other Contract Documents.

## 1.06 WORK BY OWNER

- A. Work to be performed by the Owner or Owner's designated representatives is as follows:
  - 1. Construction inspection and construction quality assurance (CQA) activities.
  - 2. Public relations.

3. Relocation of southern aboveground piping adjacent o Ash Impoundment #2.
4. Dredging of ash deposits from Ash Impoundment #2, and transportation of ash for disposal.

**PART 2 - PRODUCTS (NOT USED)**

**PART 3 - EXECUTION (NOT USED)**

**END OF SECTION**

**SECTION 01015  
GENERAL REQUIREMENTS**

---

**PART 1 - GENERAL**

1.01 SECTION INCLUDES

- A. Abbreviations
- B. Contractor's Responsibilities
- C. Other's Responsibilities
- D. Permits
- E. Measurement and Payment
- F. Estimates of Plan Quantities
- G. Construction Limits
- H. Work on Properties Owned by Others

1.02 ABBREVIATIONS

- A. Abbreviations: ANSI – American National Standard Institute  
ASTM – American Society for Testing and Materials  
IDOT – Illinois Department of Transportation  
IEPA – Illinois Environmental Protection Agency  
NEC – National Electric Code; latest edition  
NEMA – National Electrical Manufacturers Association  
NPFA – National Fire Protection Association  
OSHA – Occupational Safety and Health Administration

1.03 CONTRACTOR'S RESPONSIBILITIES

- A. Become familiar with conditions relating to execution of Work. Neglect of this requirement will not be accepted as a basis for additional compensation.
- B. Schedule operations to coordinate work of Contractor's forces, subcontractors, and suppliers to meet project schedule and completion date.
- C. Obtain complete data of site and inspect areas scheduled to receive Work before proceeding with such Work.
- D. Obtain any permits necessary to haul materials or equipment on public streets and highways. Obey load restrictions at all times.

- E. Take all precautions required to maintain the integrity and structural stability of the existing structures and utilities.
- F. Maintain vehicle access on private roads for plant personnel.
- G. Repair or clean public or private roads or driveways following damage or spillage.
- H. Be solely responsible for obtaining and verifying accuracy of measurements and layout of Work.
- I. Correct deficiencies, errors, or defects due to faulty measurements, information, layout, or due to failure to report discrepancies.
- J. Immediately notify Owner and/or Engineer in writing in case of discrepancies between existing work and drawings or defects on such surfaces that are to receive work prior to commencing work. Failure to notify Owner and/or Engineer of such discrepancies and/or defects shall be done at expense of Contractor who applied work to defective surfaces.
- K. Location of existing underground and aboveground utilities, structures, and other obstructions shown on Contract Drawings are taken from existing information and are approximate only. Obstructions not shown on the Drawings may exist and shall be exposed by Contractor without damage. Contractor shall be responsible for damage to existing facilities and utilities resulting from Contractor's operations and shall repair or replace damaged items to Owner's satisfaction.

1.04 OTHER'S RESPONSIBILITIES

- A. Owner and/or Engineer shall be responsible for scheduling performance of Work by Owner or others.
- B. Owner and/or Engineer shall be responsible to maintain daily contact with Contractor during progress of work.

1.05 PERMITS

- A. Permits
  - 1. Owner has obtained IEPA Water Pollution Control Construction Permit required for project.
  - 2. Copies of permits and approvals provided by the Owner will be made available to the Contractor.
  - 3. Copies of Permits obtained by the Contractor shall be provided to the Owner.

1.06 ESTIMATES OF PLAN QUANTITIES

- A. Quantities of materials provided in these plans and specifications are estimates and are to be verified by the Contractor prior to use in preparing the bid.

1.07 CONSTRUCTION LIMITS

- A. Contractor shall restrict operations and storage of materials and equipment to the area within the project site as shown on the Contract Drawings unless otherwise approved by the Owner. Owner will further define the construction limits in the field when the Contractor believes it is appropriate or upon reasonable request of Contractor. Contractor shall restore all disturbed areas within the construction limits as necessary to match pre-existing conditions.

1.08 WORK ON PROPERTIES OWNED BY OTHERS

- A. Contractor shall be familiar with property boundaries and those of the adjacent properties at the site where work is to be conducted.
- B. Storage of materials or equipment on property owned by others is not allowed unless as authorized by the Owner.
- C. Notify and receive advance approval of the Owner of need to remove or disturb materials not addressed by these documents.

**PART 2 - PRODUCTS (NOT USED)**

**PART 3 - EXECUTION (NOT USED)**

**END OF SECTION**

**SECTION 01040  
PROJECT ADMINISTRATION**

---

**PART 1 - GENERAL**

1.01 SECTION INCLUDES

- A. Contractor Supervision and Subcontracted Work
- B. Submittals
- C. Project Meetings
- D. Construction Schedule
- E. Work Hours and Coordination
- F. Reports

1.02 RELATED SECTIONS

- A. Section 01050-Field Engineering and Surveying
- B. Section 01300-Submittals
- C. Section 01400-Quality Assurance and Control

1.03 CONTRACTOR SUPERVISION AND SUBCONTRACTED WORK

- A. Assign one superintendent or foreman to be on site continuously during working hours from start to finish of project. Submit site superintendent/foreman's name and phone number prior to project start. The superintendent shall be the primary contact with the Owner and/or Engineer and shall be responsible for all negotiated change orders. If Contractor changes foreman assigned to site, Contractor shall make transition seamless to avoid lost work. In the event of a change in supervisory staff, the Owner shall be provided a minimum of two weeks notice prior to making the change.
- B. Use an adequate number of skilled workers who are thoroughly trained and experienced and who are completely familiar with specified requirements and methods needed for performance of Work.
- C. Use experienced professional personnel for that work which requires judgment, knowledge, and expertise of qualified professionals, and who are familiar with all aspects of Work.



- D. Contractor's superintendent/foreman shall maintain communication between subcontracted personnel and Contractor's personnel, and shall be on site when subcontractors are on site performing work.
- E. Contractor shall direct and supervise all Subcontractors.
- F. Contractor shall submit names of all Subcontractors who will be performing any work with bid.

1.04 SUBMITTALS

- A. As required in accordance with this Section, Section 01300 and Table 2.

1.05 PROJECT MEETINGS

- A. A pre-construction meeting will be conducted by the Owner and/or Engineer. Contractor shall submit all submittals required prior to the project start prior to the pre-construction meeting. Meeting shall be held at the site unless otherwise announced. At a minimum, the following personnel shall attend: Contractor, including site superintendent/foreman, geosynthetics installer's site superintendent / foreman, Owner and/or Engineer. The agenda for the meeting shall include, but not be limited to:

1. Review work scope.
2. Review status of submittals required to be transmitted prior to project commencement.
3. Discuss project administration prior to start of work.
4. Determine frequency and schedule for progress meetings.
5. Discuss the coordination and scheduling of each major element of the construction, including but not be limited to, site preparation, excavation and grading, anchor trench, geomembrane installation, backfilling, leak location survey, and site restoration.
6. Discuss Owner's emergency notification and operating practices for emergency situations.

- B. The Owner and/or Engineer will conduct regular progress meetings for the purpose of coordinating and inspecting Work. All parties will agree upon the frequency and schedule for progress meetings at the pre-construction meeting. Contractor and subcontractors shall attend weekly progress meetings during the duration of each subcontractor's work.

- C. Owner and/or Engineer will conduct a final inspection meeting for purpose of confirming project is complete and consistent with Contract Documents. Meeting will be scheduled when Contractor has submitted written certification to Owner that the Contract Documents have been reviewed, Work has been inspected, and that Work is Substantially Complete in accordance with Contract Documents and ready for final inspection (Section 01700).
- D. A principal member of Contractor's staff, authorized to make decisions on his behalf, shall represent Contractor at each meeting. Owner and/or Engineer may direct certain subcontractors to attend meetings as needed. Failure to attend a meeting does not relieve Contractor from acting on contents of meetings.
- E. Owner and/or Engineer will record all pertinent topics discussed and any resulting action items in the minutes of the project meetings. Meeting minutes will be distributed prior to the next meeting to all parties in attendance and responsible for action items.
- F. Special meetings may be called at discretion of the Owner and/or Engineer for the purpose of resolving problems or other purposes concerning Work. Attendance at special meetings is mandatory for Contractor and other parties requested by Owner and/or Engineer to attend.

1.06 CONSTRUCTION SCHEDULE

- A. Overall work is to be completed as indicated in these Technical Specifications.
- B. A Baseline Construction Schedule is required to be submitted with the Contractor's bid. Within 10 working days of date of contract award, Contractor shall submit to Company and/or Engineer for review one updated copy of the Baseline Construction Schedule. Schedule shall be time-scaled and show work activities, including sequence of performance and interdependency. Each activity shall be labeled and include an estimated duration in working days. Baseline Construction Schedule shall comply with required completion date stated in Contract Documents and any work restrictions, including restrictions on days or hours of work, stated in Technical Specifications. Baseline Construction Schedule shall be discussed at pre-construction meeting.
- C. The Contractor shall update the Baseline Construction Schedule during Construction to indicate actual progress in percent completion for each activity and submit one updated copy to the Owner and/or Engineer one work day prior to the regularly scheduled progress meeting. This updated schedule is termed "Progress Schedule". In addition to indicating actual progress, the Progress Schedule shall also indicate any changes in completion times or dates for any of activities shown on previous version.

- D. Each Progress Schedule shall be submitted with a written narrative describing revisions, if any, from the previous version, the effects of these revisions upon remaining Work and schedule, and corrective actions taken or proposed by Contractor.
- E. Owner and/or Engineer shall review the Contractor's Baseline Construction Schedule and Progress Schedules. Comments made by Owner and/or Engineer on Schedule, lack of such comments, rejection, or acceptance of Contractor's Schedule does not relieve Contractor from compliance with Contract Documents, nor create any responsibility or duty for scheduling owed from Owner and/or Engineer to Contractor. This review, whether accompanied by comments, rejection, or neither, is only for general conformance with information provided in the Contract Documents.
- F. Any contingency within Schedule (i.e., a difference in time between project's early completion and required completion dates) will belong to Project and not any parties to Contract.
- G. Contractor shall furnish material and labor at proper time and in sufficient quantities to correspond with actual job progress whether or not such actual progress is in conformance with subsequent Progress Schedules.
- H. Should Contractor fail to adhere to the Baseline Construction Schedule or revised Progress Schedules, Contractor shall promptly take measures necessary to regain conformance with such schedules at no additional cost to Owner. Addition of equipment or construction forces, increase in working hours, or any other method, manner, or procedure to return to Schedule shall not be considered justification for a request for additional compensation or treated as an acceleration order. If, in opinion of the Owner, methods prove unsuccessful in compensating for lost time, Owner shall have right to pursue remedies, as described in Agreement and General Conditions of Contract Documents.

1.07 WORK HOURS AND COORDINATION

- A. Contractor shall perform work during a regular workweek of ten hours per day, Monday through Friday. Working hours will be 7:00 a.m. to 5:00 p.m. Saturday work and hours shall be reviewed with the Owner on a case by case basis.
- B. Contractor shall keep the Owner and/or Engineer informed, at reasonable time in advance or as required by specific sections of Technical Specifications, of times and places where work is to be done, so that any inspection or oversight deemed necessary may be done with minimum inconvenience to the Owner and/or Engineer.

1.08 REPORTS

A. Contractor shall be responsible for submitting to the Owner and/or Engineer a progress report one work day prior to a regularly scheduled progress meeting. Progress report shall include following:

1. A brief description of work completed during the current reporting period.
2. Quantities and volumes of work completed during the current reporting period.
3. Contractor's summary of work completed and estimate of percentage of completion for each work item.
4. Erosion control inspection records, as necessary.
5. A list of work scheduled for the next reporting period.
6. Quantities and volumes of work anticipated for the next reporting period.
7. A list and number of supervision and craft people on site by craft.
8. A review of conditions affecting execution of work, including encountered or anticipated problem areas, including delays and causes.

B. Contractor shall be required to submit the following special reports:

1. Accident Reports
2. Work Stoppage/Dispute Records
3. Contractor's Invoices
4. Schedule of Values
5. Test Report Records
6. Equipment Check Reports

**PART 2 - PRODUCTS (NOT USED)**

**PART 3 - EXECUTION (NOT USED)**

**END OF SECTION**

**SECTION 01050  
FIELD ENGINEERING AND SURVEYING**

---

**PART 1 – GENERAL**

1.01 SECTION INCLUDES

- A. Work by Contractor
- B. Contractor's Responsibilities and Submittals
- C. Survey Data for Construction Documentation
- D. Construction Documentation Drawings

1.02 WORK BY CONTRACTOR: Contractor shall provide field engineering and surveying services as required for proper completion of work including:

- A. Documenting location of anchor trench.
- B. Documenting location and elevation of geomembrane panels.
- C. Documenting location of marker posts.
- D. Documenting topography of warning layer.

1.03 CONTRACTOR'S RESPONSIBILITIES AND SUBMITTALS

- A. Upon commencement of construction work, become familiar with the location of existing benchmarks, control points, and other necessary reference points. Maintain their accuracy and prevent disturbance or destruction. Contractor is responsible for re-establishing control points and benchmarks if such items are damaged and/or destroyed at no cost to Owner.
- B. Establish and verify grades, lines, levels, locations and dimensions as shown on Drawings and report any errors or inconsistencies to Owner and/or Engineer before commencing work.
- C. Initial staking of discharge pipe and anchor trench.
- D. Lay out own work and be responsible for all surveys, lines, elevations, and measurements of structures and other work executed under Contract. Exercise proper preparation to verify figures on Drawings within construction limits before laying out work. Any error resulting from failure to exercise such precautions or work done without being properly located may be removed at Owner's direction and corrected or replaced at Contractor's expense.
- F. Contractor shall verify its own work with respect to required grades prior to documentation surveys. Areas deficient will be corrected and resurveyed at Contractor's expense.

1.04 SURVEY DATA FOR CONSTRUCTION DOCUMENTATION

- A. Survey work performed by Contractor shall be certified by a registered land surveyor (RLS), and will include items identified in Table 1.
- B. Frequency of surveys for each item is summarized in Table 1 and relevant Sections of the Technical Specifications.
- C. Survey data shall be supplied to Owner and/or Engineer in one of the following formats within two working days after completion of survey:
  - 1. Topographic map (hard copy and electronic file compatible with AutoCAD).
  - 2. Tabular (according to Table 1).
  - 3. ASCII files (northing, easting, elevation).
- D. Contractor will be notified by Owner and/or Engineer of areas to be adjusted or will be given written approval of surveyed area within two working days of receiving survey data.
- E. Contractor shall obtain written approval from Owner and/or Engineer for each surveyed area prior to placement of any overlying materials.

1.05 CONSTRUCTION DOCUMENTATION DRAWINGS

- A. Contractor shall distribute record drawings to Owner and/or Engineer based on results of documentation survey within four working days following completion of survey for a particular surface or set of features as supplied by the RLS.

**PART 2 - PRODUCTS (NOT USED)**

**PART 3 - EXECUTION (NOT USED)**

**END OF SECTION**

**SECTION 01300  
SUBMITTALS**

---

**PART 1 - GENERAL**

1.01 SECTION INCLUDES

- A. General Requirements
- B. Submittal Format
- C. Submittal Procedures

1.02 GENERAL REQUIREMENTS

- A. Procedures and format for submittals required by the Technical Specifications that may include but are not limited to:
  - 1. Soil and/or material test data
  - 2. Survey data
  - 3. Product test data
  - 4. Progress reports
  - 5. Shop drawings
  - 6. Manufacturers instructions, certificates, guarantees and warranties
  - 7. Management, staging and sequencing plans
  - 8. Schedules
- B. Refer to Technical Specifications and Table 2 for list of submittals.

1.03 SUBMITTAL FORMAT

- A. All submittals shall be transmitted by Contractor with the following identified on the cover sheet:
  - 1. Project name and contract number.
  - 2. Applicable Technical Specification (Section) and submittal number.



- 3. Date (or revision number).
- 4. Sequential page numbers.
- B. Submittals shall be made in triplicate.
- C. Stamp, sign, or initial submittal certifying products or field dimensions, whichever pertains, are in accordance with requirements of Work and Contract Documents.

1.04 SUBMITTAL PROCEDURES

- A. Provide all submittals and information as identified in Technical Specifications to named parties in the time frames indicated in Table 2. Payments may be withheld, in whole or in part, at discretion of the Owner in the event that submittals are not made within times specified unless previously requested in writing by the Contractor (to Owner and/or Engineer) and approved in writing by Owner and/or Engineer.
- B. Transmit submittals by appropriate means to expedite review of submittal. Submittals delivered by hand, facsimile, or mail service are acceptable. Business addresses of project representatives will be provided at the pre-construction meeting.
- C. Submittals shall be made far enough in advance of the scheduled approval dates to allow adequate time for reviews, approvals, and revisions.
- D. Submittals shall identify variations from Contract Documents and product or system limitations that may be detrimental to successful performance of completed work.

**PART 2 - PRODUCTS (NOT USED)**

**PART 3 - EXECUTION (NOT USED)**

**END OF SECTION**

**SECTION 01400**  
**QUALITY ASSURANCE AND CONTROL**

---

**PART 1 - GENERAL**

1.01 SECTION INCLUDES

- A. Construction Quality Assurance
- B. Contractor's Role
- C. Engineer's Role
- D. Owner's Role

1.02 CONSTRUCTION QUALITY ASSURANCE

- A. Owner shall arrange for and inform Contractor of inspection and testing activities to confirm that the construction activities and completed Work complies with Technical Specifications and Contract Drawings.
- B. Owner's inspection and testing activities shall consist of following activities:
  - 1. Daily observation and record of Contractor activities.
  - 2. Arrange for in-place soil compaction testing, as necessary.
  - 3. Obtain material samples and transport samples to laboratory, as necessary.
  - 4. On-site visual material inspection and testing.
  - 5. Verifying compliance with Technical Specifications and Drawings.

1.03 CONTRACTOR'S ROLE

- A. Perform work in strict accordance with Technical Specifications and Drawings, using necessary construction procedures and techniques. Coordinate, supervise, and oversee subcontractors as needed to perform construction activities.
- B. Perform testing as deemed necessary to satisfy requirements of Technical Specifications related to off-site materials prior to delivery to site. Materials that do not meet specifications shall be removed from site at Contractor's expense.
- C. Contractor shall replace and/or recompact material at Contractor's expense, if soil compaction not acceptable per compaction requirements.
- D. Furnish material samples and provide assistance in on-site inspection and test activities.

- E. Provide submittals required by Contract Documents within times specified. Failure to do so will result in withholding of payment.
- F. Perform or arrange survey and layout work to construct Work in accordance with Drawings and applicable sections of Technical Specifications.
- G. If manufacturer's instructions and/or standard industry practice conflicts with Technical Specifications or Drawings request clarification from Owner and/or Engineer before proceeding.
- H. Communicate any pertinent issues with the Owner and/or Engineer.

1.04 ENGINEER'S ROLE

- A. Provide clarifications to Technical Specifications and Drawings, as well as any necessary design changes requested by the Owner.
- B. Issue a Field Directive in cases where deviation from specified design, Technical Specifications and Drawings is necessary.
- C. Communicate any pertinent issues with the Owner and/or Contractor.
- D. Confirm construction compliance with Technical Specifications and Drawings by performing observations, inspections, verifications, and documentation activities, as directed by Owner.
- E. Provide photo documentation and daily written reports documenting construction according to the Technical Specifications and Drawings, as directed by Owner.
- F. Perform or observe soil and/or geosynthetic inspections and testing to confirm materials meet requirements herein, as directed by Owner.

1.05 OWNER'S ROLE

- A. Perform Owner's engineering review and monitor construction progress, progress payment approval, and approval of field job orders.
- B. Confirm construction compliance with Technical Specifications and Drawings by performing observations, inspections, verifications, and documentation activities, as necessary.
- C. Perform Owner's administrative and managerial responsibilities. Owner has authority to accept/reject materials and workmanship, and for dispute resolution.
- D. Communicate any pertinent issues with Contractor and/or Engineer. Maintain communication with IEPA, as necessary.

**PART 2 - PRODUCTS (NOT USED)**

**PART 3 - EXECUTION (NOT USED)**

**END OF SECTION**

**SECTION 01500**  
**CONSTRUCTION FACILITIES AND TEMPORARY CONTROLS**

---

**PART 1 - GENERAL**

1.01 SECTION INCLUDES

- A. Use of Site Facilities
- B. Security
- C. Parking
- D. Telephone Service
- E. Temporary Utilities
- F. Sanitary Facilities
- G. Equipment Storage Locations
- H. Dust and Mud Controls
- I. Fugitive Emissions Controls
- J. Construction Noise
- K. Water and Erosion Controls
- L. Barriers and protection of installed work.
- M. Site Progress Cleaning
- N. Fuel Storage and Handling
- O. Protection of the environment
- P. Public Road Requirements
- Q. Additional Requirements

1.02 USE OF SITE FACILITIES

A. Use of Site

1. Contractor shall consult with the Owner and/or Engineer regarding locations for offices, trailers, material storage, access roads, fences, gates, and areas within construction limits for use by Contractor.
2. Contractor shall conduct construction activities in a manner to minimize interference with plant operations.
3. Confine equipment, storage of materials, and operations of workmen to areas designated by the Owner. Do not bring materials onto site until reasonably required for progress of work. No area outside of construction limit or staging area may be used for any purpose by Contractor or subcontractors unless expressly approved by the Owner in writing.
4. Store, place, and handle material and equipment to protect from any damage. Contractor shall move materials, sheds, or storage platforms, as necessary or when required for continuing construction at Contractor's expense.
5. Owner assumes no responsibility for project material or equipment stored on site or off site. Contractor assumes full responsibility for damage due to storage of materials.
6. Contractor is responsible to schedule work, storage of materials, etc., to minimize interference with construction activities.
7. Contractor is responsible for all snow removal as necessary during duration of project, as necessary.
8. Contractor is responsible for controlling sediment migration, preventing tracking of sediment onto site access roads and public roads along haul routes, and cleaning site access roads and public right-of-ways and streets daily or as deemed necessary by Owner with commercial street sweepers.

- B. Contractor shall inspect site with Owner and/or Engineer prior to start of work to determine existing conditions in conjunction with preconstruction meeting (Section 01040).

1.03 SECURITY

- A. Security is not provided by Owner for Contractor's property.

- B. Contractor is responsible for loss or injury to persons or property where his work is involved, and shall provide security and take precautionary measures as deemed necessary to protect Contractor's and Owner's interests.

1.04 ACCESS ROADS AND PARKING

- A. Contractor shall maintain the service road accessing the construction areas and stockpile areas as necessary, or as directed by Owner and/or Engineer.

- B. Parking areas on site shall be within the work area or area designated by Owner

1.05 TELEPHONE SERVICE

- A. Contractor shall provide, maintain and pay for cellular phone service for Contractor's designated on-site superintendent or foreman. In addition, subcontractor's designated on-site personnel shall have cellular phones.

1.06 TEMPORARY UTILITIES

- A. Electricity

1. Contractor shall arrange and pay for temporary electrical service as needed.
3. OSHA regulations require that employers shall use either ground fault circuit interrupters or an assured equipment grounding conductor program in addition to any other regulations for equipment grounding conductors.
4. Utilize and remove upon completion of project an electrical distribution system for temporary light and power during construction, if necessary.

- B. Water

1. Water is not available on site.
2. Contractor shall provide clean water to be used for dust suppression in work areas. Dust suppression will be necessary for haul roads, stockpile areas, and within construction limits. Submit source of clean water to be used for dust suppression to Owner and/or Engineer for approval prior to project commencement.
3. Contractor shall provide potable water for Contractor's employees, as necessary.



1.07 SANITARY FACILITIES

- A. Contractor shall provide sanitary facilities on site conforming to state and local health and sanitation regulations in sufficient number for use of Contractor's employees.
- B. Contractor shall maintain on-site facilities in sanitary condition at all times.

1.08 EQUIPMENT STORAGE LOCATIONS

- A. Contractor shall park equipment and store materials only in areas proposed by Contractor and approved by Owner.
- B. Restore disturbed areas to pre-construction condition upon project completion.

1.09 DUST AND MUD CONTROLS

- A. Conduct operations and maintain site at all times to minimize creation and dispersion of dust and mud.
- B. Provide equipment necessary to control dust generation resulting from wind effects on open stockpiles, excavations, and from Contractor's vehicle and equipment traffic at all times. Control dust by application of water to affected areas, such that surfaces are moistened to prevent dust from becoming a nuisance to public, neighbors, and concurrent performance of other work at site. Contractor shall prevent dusting 24 hours a day from project commencement to substantial completion of the work.
- C. Control mud and tracking of mud on site access roads and public roads along haul routes. Maintain surfaces in proper condition to facilitate removal efficiency.
- D. The Owner and/or Engineer shall monitor site conditions related to dust and mud generation on a daily basis and direct Contractor to take actions as necessary to address deficient practices or conditions deleterious to construction and/or public.
- E. Clean public right-of-ways and streets as deemed necessary by Owner with commercial street sweepers.

1.10 CONSTRUCTION NOISE

- A. The Owner shall decide on the adequacy of provision and maintenance of noise reduction equipment. When so instructed by the Owner, the Contractor shall immediately withdraw any item of plant or equipment from service and carry out all necessary additions, replacements, or repairs to the noise reduction equipment to the satisfaction of the Owner.

1.11 WATER AND EROSION CONTROLS

- A. Contractor shall install and maintain erosion control measures necessary to prevent runoff, tracking, or loss of soil materials by water or mechanical action from disturbed portions of the site or excavation areas(s).
- B. No direct discharge shall be allowed into Ash Impoundment #1 without the approval from Owner.

1.12 BARRIERS AND PROTECTION OF INSTALLED WORK

- A. Contractor shall protect installed work and provide special protection as needed.
- B. Construction traffic shall be prohibited on completed and/or landscaped areas.
- C. Protect existing facilities and adjacent properties from damage during construction operations.

1.13 SITE PROGRESS CLEANING

- A. Maintain areas free of waste materials, debris, and rubbish. Site shall be maintained in clean and orderly condition.
- B. Remove waste materials, debris, and rubbish from site weekly and dispose off-site at Contractor's expense and in accordance with federal, state and local regulations.
- C. Contractor shall provide a dumpster on site for general waste materials and rubbish during site activities.

1.14 FUEL STORAGE

- A. Store fuel according to local, state, and federal laws.

1.15 FUEL HANDLING

- A. At no time shall overtopping fuel tanks or spillage to the ground surface be allowed.

1.16 PROTECTION OF THE ENVIRONMENT

- A. Minimize air pollution by use of properly operating emission control devices on construction vehicles and equipment. Encourage shutdown of motorized equipment not in use.
- B. Trash burning not permitted on site.

- C. All areas for handling and storage of fuels, oils, and other potentially hazardous liquids shall have spill containment or release prevention measures. Maintenance of equipment on site shall be with prior approval of the Owner and/or Engineer.
- D. All waste materials shall be recycled, hauled to a licensed solid waste landfill, or otherwise disposed of in an environmentally sound manner and in compliance with all applicable local, state, and federal rules.
- E. All hazardous waste shall be stored, handled, and disposed of in compliance with applicable local, state and federal rules.
- F. Other measures shall be taken, as necessary, to maintain work site in an environmentally sound matter.
- G. All spills or leaks of fuels, oil, or other IEPA-reportable liquids resulting from handling or equipment malfunctions shall be reported immediately to Owner and/or Engineer. Affected soils shall be properly removed from limits of construction and disposed in accordance with applicable local, state and federal rules at the sole expense of the Contractor and as agreed by the Owner and/or Engineer. Copies of manifests, if necessary, shall be provided to Owner and/or Engineer within five working days of disposal. Waste Generator Manifests shall not state Owner as Generator. Owner reserves right to order leaking equipment removed from site.

1.17 PUBLIC ROAD REQUIREMENTS

- A. Contractor shall comply with Local Weight Limits. Local roads shall be cleaned daily, as necessary, to maintain their condition free of mud and dirt.
- B. The Contractor shall conduct his operations on the site in a manner that will minimize interference with the normal operation of plant, adjoining public and private roads and parking lots, and shall implement all specified and other appropriate measures to ensure the safety of all users of the adjoining public and private roads and parking lots.
- C. Contractor shall provide flag person(s) as necessary and at request of Owner and/or Engineer.

1.18 ADDITIONAL REQUIREMENTS

- A. No cameras are allowed on the site without permission from the Owner.
- B. No firearms or explosives are allowed on site.
- C. Possession and/or use of intoxicating beverages and nonprescription drugs are prohibited at all times. Persons caught in possession or under the influence of drugs or alcohol will be immediately dismissed and removed from the site.
- D. Smoking will be allowed in designated areas only.

- E. No horseplay is permitted on the job site.
- F. Visitors or personnel not employed by the Contractor or his approved Subcontractors shall not be permitted on site without prior approval by the Owner.
- G. Owner and/or Engineer reserve the right to require that any of the Contractor's personnel be excluded from work at the site at any time.

**PART 2 – PRODUCTS (NOT USED)**

**PART 3 – EXECUTION (NOT USED)**

**END OF SECTION**

**SECTION 01700  
PROJECT CLOSEOUT**

---

**PART 1 - GENERAL**

1.01 SECTION INCLUDES

- A. Description of Work
- B. Procedures
- C. Record Documents

1.02 DESCRIPTION OF WORK

- A. To provide an orderly and efficient transfer of the completed Work to the Owner.

1.03 PROCEDURES

- A. Remove temporary above grade or buried utilities, equipment, materials, prior to final application or payment inspection, and clean and repair damage caused by installation or use of temporary facilities.
- B. Substantial Completion: When all work described in the contract documents is completed:
  - 1. Owner and/or Engineer will prepare and submit a list of items to be completed for Contractor review and completion.
  - 2. Should the Owner and/or Engineer determine that the Work is not substantially complete; Contractor will remedy the deficiencies and notify the Owner and/or Engineer when ready for re-inspection.
- C. Final Completion:
  - 1. Remove waste and surplus materials, rubbish, and construction facilities from site.
  - 2. Prepare and submit the notice that all Work is complete.
  - 3. Certify in writing that the Work is complete and ready for final inspection.
  - 4. Owner and/or Engineer will make a final inspection to verify status of completion.

1.04 RECORD DOCUMENTS

- A. Contractor will maintain on site one set of following record documents of all items of work; record actual revisions of all items of work:
  - 1. Drawings.
  - 2. Technical Specifications.
  - 3. Change orders and other modifications to contract.
  - 4. A copy of approvals of work performed.
  - 5. Record documents.
- B. Engineer, as directed by Owner, will record information concurrent with construction progress including changes made by addenda and modifications.
- C. Contractor will maintain a Daily Field Log including work times, personnel on site, equipment used, and other essential information of the operation's progress.

**PART 2 - PRODUCTS (NOT USED)**

**PART 3 - EXECUTION (NOT USED)**

**END OF SECTION**

Electronic Filing: Received, Clerk's Office 3/24/2022

**DIVISION 2**

**MWG13-15\_18689**



**DIVISION 2**  
**SITE WORK**

**SECTION 02300  
EARTHWORK**

---

**PART 1 - GENERAL**

**1.01 WORK INCLUDES**

- A. Preparation of Ash Impoundment 2 liner subgrade by clearing and grubbing vegetation and removing rocks and other debris greater than 3 inches in diameter along side slopes and base of impoundment, and excavating at least 18 inches of existing ramp surface material.
- B. Load and transport rocks and other debris removed from liner subgrade to an approved recycling or disposal facility.
- C. Load and transport excavated ramp material to a stockpile area on site, as directed by Owner, for reuse at project completion.
- D. Installation of marker posts along toe of the Ash Impoundment side slopes, as shown on Contract Drawings, prior to installation of geomembrane.
- E. Trenching, backfilling, and compaction for anchoring geomembrane and geotextile including field verifying the location of discharge pipes, protection and maintenance of trench, and support of existing structures (i.e., aboveground piping, outlet and inlet).
- F. Load and transport excess trench spoils to an approved recycling or disposal facility.
- G. Placement, grading and compaction of sand material including weighting and transporting to site following installation of geomembrane.
- H. Placement, grading and compaction of warning layer material including weighing and transporting to site following placement of sand material.
- I. Placement of riprap at base of inlet apron.
- J. Placement, grading, and compaction of excavated ramp material, including loading and transporting from on-site stockpile area to the ash impoundment ramp following installation of geomembrane.

**1.02 RELATED SECTIONS**

- A. Section 01050 – Field Engineering and Surveying
- B. Section 02600 – HDPE Geomembrane

1.03 DEFINITIONS

- A. Structures and Surface Features: Existing structures and surface features including buildings, signs, posts, utility poles, monitoring wells, fences, trees, shrubs, landscaped surface features, and other miscellaneous items.
- B. Utilities: Existing gas mains, water mains, electric lines, storm sewers and conduits, telephone and other communication lines and conduits, sewer pipe, cable television, other utilities, and appurtenances.
- C. Clearing and Grubbing: cutting, removal and disposal of trees, roots, brush, stumps, windfalls, logs, and other vegetation.

1.04 REFERENCES

- A. ASTM D422-63 – Standard Test Method for Particle-Size Analysis of Soils.
- B. ASTM D2487-93 – Standard Classification of Soils for Engineering Purposes (Unified Soil Classification System).
- C. ASTM D2940 – Standard Specifications for Graded Aggregate Material for Bases or Subbases for Highways or Airports
- D. State of Illinois, Department of Transportation, Standard Specifications for Road and Bridge Construction, current edition.
- E. OSHA 29 CFR Part 1926, Occupational Safety and Health Standards Excavations.

1.05 PERFORMANCE REQUIREMENTS

- A. Excavation and grading shall be done without damage to adjacent property or structures and without interference to public and/or plant pedestrian and vehicular traffic.
- B. Provide adequate backup systems to accomplish the excavation.
- C. Complete Work to required grades as indicated in the Contract Drawings.

1.06 SUBMITTALS

- A. In accordance with Section 01300.
- B. Submit with bid a description of proposed Earthwork Plan, including but not limited to:
  - 1. Methods and equipment.
  - 2. Temporary staging facilities and stockpile locations.

3. Methods of advancing and stabilizing anchor trenches.
4. Sequence of liner subgrade preparation, shoring, grading, material staging and replacement.

If changes occur, submittal shall be revised no later than five days prior to project start. Re-submittals shall be made during course of construction if plan is modified during construction.

- C. Submit prior to start of construction the name and location of all sources that will be used to obtain the materials specified in this Section.
- D. Provide Owner and/or Engineer written notice of construction start date at least five working days prior to beginning site activities.
- E. Submit for documentation certificates and/or test results for one sample of each material obtained from off-site sources indicating compliance with Specifications prior to start of construction. Owner and/or Engineer may take random samples of the material upon delivery or placement to verify compliance with the Specifications.
- F. Submit with bid name and location of the recycling and/or disposal facility that will be used to dispose of excess material specified in this Section.

## PART 2 - PRODUCTS

### 2.01 GENERAL SOIL MATERIALS

- A. Provide borrow soil materials when sufficient satisfactory soil materials are not available from excavations.
- B. Satisfactory Soils: ASTM D2487 soil classification groups GW, GP, GM, SW, SP, and SM, or a combination of these group symbols; free of rock or gravel larger than 3 inches (75 mm) in any dimension, debris, waste, frozen materials, vegetation, and other deleterious matter.
- C. Unsatisfactory Soils: ASTM D2487 soil classification groups GC, SC, MH, CH, OL, OH, and PT, or a combination of these group symbols.
  1. Unsatisfactory soils also include satisfactory soils not maintained within 2 percent of optimum moisture content at time of compaction.
- D. Unclassified Imported Fill: Satisfactory soil materials.
- E. Excavated Ramp Material: Excavated material from the existing ramp surface that does not require disposal and may be reused as backfill, subject to Owner's and/or Engineer's approval.

- F. Anchor Trench Backfill: Trench spoils free of rock or gravel larger than 3 inches in any dimension, debris, waste, frozen materials, vegetation and other deleterious matter.
- G. Riprap at Base of Inlet Apron: Riprap shall be durable field or quarry stone between 4 and 12 inches in diameter.

#### 2.02 BASE COURSE MATERIAL (AS NEEDED)

- A. Imported base course material shall be obtained from an off-site borrow source of the Contractor's choice and shall at a minimum satisfy the following specifications:
  - 1. Naturally or artificially graded mixture of natural or crushed gravel, crushed stone, and natural or crushed sand; ASTM D 2940; with at least 95 percent passing a 1-1/2-inch sieve and not more than 8 percent passing a No. 200 sieve; and
  - 2. Other materials with greater or equal bearing characteristics with the written approval of the Owner and/or Engineer. Verify the materials meet and/or exceed the materials specified in 2.02.A.1.
- B. Contractor shall provide to Owner and/or Engineer a representative gradation (ASTM D422) and classification (ASTM D2487) for the base course material proposed for use in the project two weeks prior to delivery to site.

#### 2.03 SAND MATERIAL

- A. Conform to Section 1003.01, Fine Aggregates of Standard Specifications for Road and Bridge Construction:
  - a. Grade No. FA 1 or FA 2 shall be used; and
  - b. Other materials with greater or equal characteristics with the written approval of the Owner and/or Engineer.
- B. Contractor shall provide Owner and/or Engineer a representative gradation (ASTM D422) and classification (ASTM D2487) for the sand layer two weeks prior to delivery to site.

#### 2.04 WARNING LAYER MATERIAL

- A. Imported Warning Layer Material shall be obtained from an off-site borrow source of the Contractor's choice and shall at a minimum satisfy the following specifications:
  - 1. Conform to Section 1004.04, Coarse Aggregate for Stabilized Subbase of Standard Specifications for Road and Bridge Construction:
    - a. Grade No. CA 6 shall be used; and
    - b. Other materials with greater or equal characteristics with the written approval of the Owner and/or Engineer.

- B. Contractor shall provide Owner and/or Engineer a representative gradation (ASTM D422) and classification (ASTM D2487) for the warning layer two weeks prior to delivery to site.

**PART 3 - EXECUTION**

**3.01 PROTECTION OF UTILITIES AND STRUCTURES**

- A. At least ten business days before beginning Work, coordinate utility locate with Owner and Owner's utility locator for locating Owner's private utilities near the ash impoundments.
- B. Protect existing utilities not specified for removal against damage.
- C. Locate existing underground utilities by hand excavation.
- D. If unmarked utilities are encountered during excavation, stop work, place work in a safe condition, and notify Owner and/or Engineer.
- E. Preserve and protect benchmarks and other structures. If damaged during construction, notify Owner and/or Engineer immediately. If determined by Owner and/or Engineer that the integrity of the structure is compromised, Contractor shall repair damaged benchmarks or other structures at Contractor's expense under observation of Owner and/or Engineer.
- F. Protect, support, and maintain conduits, wires, pipes, or other utilities that are to remain in place during work as indicated in the Contract Drawings.

**3.02 PREPARATION**

- A. Contractor shall perform, as necessary, additional survey and layout to establish location, line and grades for controlling the work.
- B. Vicinity Controls
  - 1. Surface Water: Contractor is responsible for management of surface water and maintaining adequate berms and drainage to control surface water run-on into the Ash Impoundment, as needed. Surface water and run-on water may be directed to Ash Impoundment 1, as needed to complete work and as approved by Owner.
  - 2. Dust Controls: Dust shall be minimized at all times. Appropriate engineering controls shall be maintained that include using a light water spray with or without additives as approved by the Owner to minimize off-site migration of fugitive dust from stockpiles, truck routes, and other Contractor disturbed areas.

3.03 ON-SITE MATERIAL GRADING, GENERAL

- A. Uniformly grade all areas to a smooth surface, free from irregular surface changes. Provide a smooth transition between adjacent existing grades and new grades.
- B. Comply with compaction requirements and grade to cross sections, lines, and elevations indicated.
- C. Flatten or shore and brace slopes as required to maintain stability.
- D. Removal of debris or other deleterious material encountered during excavations is to be managed as required under this Section.
- E. Notify Owner and/or Engineer of unexpected subsurface conditions and discontinue work in affected area until notified to resume Work.

3.03 BACKFILLING, GENERAL

- A. Material used to construct surface water diversion berms, as needed, may be reused for backfill as directed by the Owner and/or Engineer.
- B. Imported backfill materials shall be pre-approved by the Owner and/or Engineer before delivery to the site in accordance with this Section.
- C. Materials placed, which are not conforming to the Technical Specifications, shall be reworked or removed. Replacement material and fill surfaces upon which it is placed shall conform to all requirements of this specification. All reworking or removal and replacement will be performed at Contractor's expense.
- D. Mechanical tamping around structures shall be done in no greater than 6-inch lifts.

3.04 STOCKPILING, GENERAL

- A. Stockpile materials on site at locations specified by Owner and consistent with the Contractor's Earthwork Plan.
- B. Stockpile in sufficient quantities to meet project schedule and requirements.
- C. Separate differing materials and stockpile separately to prevent mixing.
- D. Direct surface water away from stockpiles to prevent erosion or deterioration of materials, as needed.

3.05 LINER SUBGRADE

- A. Liner subgrade surface shall be graded to 3 horizontal to 1 vertical (3H:1V) along side slopes, or as approved by the Owner and/or Engineer. The base of the impoundment subgrade surface shall not exceed a 1% slope (to be relatively flat).



- B. Contractor shall prepare the liner subgrade by clearing and grubbing vegetation and removing rocks and other debris greater than 3 inches in diameter along side slopes and base of impoundment, and excavating at least 18 inches of existing ramp surface material.
- C. Proof roll subgrade with smooth-drum compactor to identify soft pockets and areas of excess yielding. Do not proof roll wet or saturated subgrade.
- D. Reconstruct liner subgrade damaged by freezing temperatures, frost, rain, accumulated water, or construction activities, as directed by the Owner and/or Engineer and Geomembrane Installer.
- E. Cut out soft spots, fill low spots, and trim high spots to comply with required surface tolerances.
- F. The surface of the subgrade shall be to the satisfaction of the Owner and/or Engineer and Geomembrane Installer, graded so it is free of irregularities, protrusions, loose soil, and abrupt changes in grade. Rocks with sharp protrusions and rocks or other debris greater than 3 inches in any dimension shall be removed.
- G. Vegetation, rocks and other debris removed during subgrade preparation shall be loaded and transported to an approved recycling or disposal facility.
- H. Excavated ramp material shall be loaded and transported to a stockpile area on-site, as directed by Owner.
- I. Ramp subgrade shall have a maximum 10% slope, and a minimum 1% slope toward the side slopes of the impoundment to divert water away from the outboard slopes of the ramp, as indicated on Contract Drawings.

### 3.06 ANCHOR TRENCH

- A. Excavate to required alignment and grade. Where feasible, Contractor shall place anchor trench at least 4 feet from top of side slopes. If not feasible, Contractor shall provide Owner and/or Engineer with proposed alignment (i.e., 2 feet from top of side slope near the aboveground pipes) for approval.
- B. Contractor shall not excavate more than the amount of anchor trench required for one day of geosynthetics deployment, unless otherwise specified by the Owner and/or Engineer. Rounded corners shall be provided in the trenches where the geosynthetics enter the trench to allow them to be uniformly supported by the subgrade and to avoid sharp bends. The geosynthetics shall not be supported by loose soils in anchor trenches.
- C. Remove water which may accumulate in trench. Water shall be pumped to Ash Impoundment 1 (active impoundment), as directed by Owner and/or Engineer.
- D. Owner and/or Engineer may limit amount of open trench where field conditions require.
- E. Owner and/or Engineer may order additional excavation where unsuitable soil conditions are encountered.

- F. Excavations shall be filled with trench spoils, as directed by Owner and/or Engineer. Care shall be taken when backfilling to prevent any damage to Geomembrane or other geosynthetics that may be placed prior to backfilling.
- G. Anchor Trench Backfill shall be mechanically compacted to a hard durable surface with no evidence of pumping or ponding of water. Backfill shall be compacted to the degree that no further appreciable consolidation is evident under the action of compaction equipment.
- H. Anchoring, backfilling, and compaction of anchor trench will be observed by Owner and/or Engineer. .

### 3.07 INSTALLATION OF MARKER POSTS

- A. Prior to deployment of the geomembrane liner, Contractor shall install marker posts along the toe of the impoundment side slopes, as shown on Contract Drawings.
- B. Contractor shall construct 4 feet deep, 1 foot diameter holes. The hole shall be backfilled with concrete and 12 foot long steel poles.
- C. Marks spaced every foot from the top of the subgrade layer shall be inscribed in the steel poles to the top of the pole, as indicated on the Contract Drawings.

### 3.08 PLACEMENT OF SAND AND WARNING LAYER MATERIALS

- A. Prior to placement of the sand and warning layer materials, the Owner and/or Engineer and Geomembrane Installer shall verify the area of geomembrane completion and provide Contractor notification to proceed with placement of sand and warning layers.
- B. Contractor shall place sand material to achieve 12-inch thickness over the 12-oz non woven geotextile within the Ash Impoundment, as indicated on Contract Drawings. The sand material shall be placed at least 4 feet along the impoundment's side slopes over the non woven geotextile.
- C. Contractor shall place warning layer material to achieve 6-inch thickness over the sand material within the Ash Impoundment, as indicated on Contract Drawings. The warning layer material shall be placed at least 4 feet along the impoundment's side slopes over the sand material.
- D. Sand and warning layer materials shall not be placed directly on geomembrane.
- E. Place materials evenly on all sides of structures to required elevation,
- F. Compact with tracked equipment to a hard, durable surface with no evidence of pumping or ponding of water. Materials shall be compacted to the degree that no further appreciable consolidation is evident under the action of compaction equipment.

- G. Apply following general criteria for covering of the 12-oz non woven geotextile and geomembrane liner:
  - 1. Do not place soils on the geomembrane at an ambient temperature below 32 degrees F, (0 degrees C) nor above 104 degrees F (40 degrees C), unless otherwise specified.
  - 2. Do not drive equipment used for placing soil directly on the geomembrane.
  - 3. A minimum thickness of 1 foot of soil shall be between tracked equipment and the geomembrane.
  - 4. Do not compact soils placed directly on geomembrane.
  - 5. Damage to the geomembrane resulting from placement of cover soils shall be repaired in accordance with Part 3.07 by the Geomembrane Installer at the Contractor's expense.
  - 6. Do not push soil downslope. Soil shall be placed over the geomembrane starting from base of the slope, up to top of the slope.

### 3.09 PLACEMENT OF RIPRAP

- A. Place 18-inch thick layer of riprap at the base of the inlet apron over 12 oz non woven geotextile. The non woven geotextile shall cover the geomembrane batten bar attachment.
- B. Riprap shall be placed cautiously to prevent damage to the batten bar attachment and geomembrane. Any damages to the batten bar or geomembrane shall be repaired at Contractor's expense.

### 3.11 RECONSTRUCTION OF RAMP

- A. Following installation of the geomembrane and 12-oz non woven geotextile, Contractor shall load and transport excavated ramp material from stockpile area to the impoundment. Contractor shall place and compact excavated ramp material to achieve 18 inch thickness over the 12-oz non woven geotextile to construct final ramp surface.
- B. The ramp final surface shall be a maximum 10% slope toward the base of the ramp, and a minimum 1% slope towards the 3H:1V side slopes, as indicated on Contract Drawings.
- C. Compaction shall be conducted with tracked equipment only.

3.12 MOISTURE CONTROL

- A. Do not place backfill or fill material on surfaces that are muddy, frozen, or contain frost or ice.
- B. Remove and replace, or scarify and air-dry, otherwise satisfactory soil material that is too wet to compact to specified dry unit weight.

3.10 GRADE TOLERANCE

- A. Sand layer shall have minimum thickness of 12-inches, shall have a tolerance of 0 to +0.1 feet of design grade.
- B. Warning layer shall have a minimum thickness of 6-inches, shall have a tolerance of 0 to +0.3 feet of design grade.
- C. Top of ramp surface is to be a minimum thickness of 18-inches, shall have a tolerance of 0 to +0.1 feet of design grade.
- D. Layer thickness shall be measured vertically. Minimum thickness shall be measured against previous layer grades.

3.11 PROTECTION

- A. Protecting Graded Areas: Protect newly graded areas from traffic, freezing, and erosion. Keep free of trash and debris.
- B. Repair and re-establish grades to specified tolerances where completed or partially completed surfaces become eroded, rutted, settled, or where they lose compaction due to subsequent construction operations or weather conditions.
  - 1. Scarify or remove and replace soil material to depth as directed by Owner and/or Engineer, reshape and recompact.
- C. Where settling occurs before Project correction period elapses, remove finished surfacing, backfill with additional soil material, compact, and reconstruct surfacing.
  - 1. Restore appearance, quality, and condition of finished surfacing to match adjacent work, and eliminate evidence of restoration to the greatest extent possible.

3.13 SITE RESTORATION AND CLEANUP

- A. Remove surplus soil and waste material, including unsatisfactory soil, trash, and debris, and transport off-site for disposal as directed by the Owner.
- B. Restore pavement, base course, topsoil, landscaping, and utilities which are disturbed during the performance of the Work to preconstruction condition.
- C. Temporary erosion control measures shall be removed.

- D. Contractor shall correct, at no expense to the Owner, any damage to buildings, telephone or other cables, overhead and underground utilities or their structures as a result of his construction, whether or not the item is shown on the Contract Drawings.
- E. All Contractor equipment and materials shall be removed from the site.

**END OF SECTION**

**SECTION 02600**  
**HIGH DENSITY POLYETHYLENE (HDPE) GEOMEMBRANE**

---

**PART 1 - GENERAL**

**1.01 WORK INCLUDES**

- A. Furnish all labor, materials, tools, supervision, transportation, and installation equipment necessary for installation of 60-mil High Density Polyethylene (HDPE) geomembrane, as specified herein, and as shown on Contract Drawings.

**1.02 REFERENCE STANDARDS**

- A. ASTM D1004 – Test Method for Initial Tear Resistance of Plastic Film and Sheeting.
- B. ASTM D1238 – Standard Test Method for Flow Rates of Thermoplastics by Extrusion Plastometer.
- C. ASTM D1505 – Test Method for Density of Plastics by the Density-Gradient Technique.
- D. ASTM D1603 – Test Method for Carbon Black in Olefin Plastics.
- E. ASTM D4833 – Standard Test Method for Index Puncture Resistance of Geotextiles, Geomembranes, and Related Products.
- F. ASTM D5199 – Standard Test Method for Measuring Nominal Thickness of Geotextiles and Geomembranes.
- G. ASTM D5397 – Standard Test Method for Evaluation of Stress Crack Resistance of Polyolefin Geomembranes Using Notched Constant Tensile Load Test.
- H. ASTM D5596 – Test Method for Microscopic Evaluation of Dispersion of Carbon Black in Polyolefin Geosynthetics.
- I. ASTM D5994 Standard Test Method for Measuring Core Thickness of Textured Geomembranes.
- J. ASTM D6392 – Test Method for Determining the Integrity of Nonreinforced Geomembrane Seams Produced Using Thermo-Fusion Methods.
- K. ASTM D6693 Standard Test Method for Determining Tensile Properties of Nonreinforced Polyethylene and Nonreinforced Flexible Polypropylene Geomembranes.
- L. ASTM D7007 Standard Practice for Locating Leaks in Geomembranes Covered with Water or Earthen Materials.
- M. GRI Test Method, GM 13 - Test Methods, Test Properties and Testing Frequency for High Density Polyethylene (HDPE) Smooth and Textured Geomembranes

- N. GRI Test Method, GM 14 – Selecting Variable Intervals for Taking Geomembrane Destructive Seam Samples Using the Method of Attributes.
- O. GRI Test Method, GM 19 – Seam Strength and Related Properties of Thermally Bonded Polyolefin Geomembranes.

1.03 DEFINITIONS

- A. Geomembrane Installer: hired by Contractor responsible for field handling, transporting, storing, deploying, seaming and testing of the geomembrane seams.
- B. Geomembrane Manufacturer: hired by Geomembrane Installer to provide HDPE geomembrane.
- C. Leak Location Contractor: hired by Contractor and responsible for locating potential holes in the installed geomembrane using electrical methods.
- D. Geosynthetic Quality Assurance Laboratory (Testing Laboratory): Party, independent from the Owner, Manufacturer and Installer, responsible for conducting laboratory tests on samples of geosynthetics obtained at the site or during manufacturing, usually under the direction of the Owner.
- E. Lot: A quantity of resin (usually the capacity of one rail car) used in the manufacture of geomembranes. Finished roll will be identified by a roll number traceable to the resin lot used.
- F. Resin Supplier: selected by Geomembrane Manufacturer to provide resin used in manufacturing geomembrane.
- G. Panel: Unit area of a geomembrane that will be seamed in the field that is larger than 100ft<sup>2</sup>.
- H. Patch: Unit area of a geomembrane that will be seamed in the field that is less than 100ft<sup>2</sup>.
- I. Subgrade Surface (Bedding Layer): Soil Layer surface which immediately underlies the geosynthetic material(s).

1.04 QUALITY ASSURANCE

- A. Qualifications:
  - 1. Geomembrane Installer:
    - a. 5 years of continuous experience in installation of HDPE geomembrane.
    - b. Experience totaling a minimum of 5,000,000 square feet of installed HDPE geomembrane on some combination of at least 10 completed facilities.



- c. Personnel performing seaming operations qualified by experience or by successfully passing seaming tests. Master seamer shall have experience seaming a minimum of 3,000,000 square feet of geomembrane using same type of seaming apparatus to be used on this project.
2. Leak Location Contractor:
    - a. 3 years of continuous experience in performing leak location surveys using electrical methods.
    - b. Experience totaling a minimum of 2,000,000 square feet of geomembrane leak location surveys on some combination of at least 5 completed facilities.
    - c. Personnel performing survey qualified by experience with at least 2 years of geomembrane testing experience using the leak location survey electrical method.
    - d. Leak Location Contractors that are qualified and approved by Engineer are listed below:
      - i. Leak Location Services, Inc.  
San Antonio, TX  
210-408-1241
      - ii. The Hutchinson Group, Ltd.  
Murrysville, Pennsylvania  
724-325-3996
      - iii. Or other approved by Owner and/or Engineer.
- B. Quality Assurance Program:
    1. Geomembrane Manufacturer/Installer shall conform with requirements of these Technical Specifications.
    2. The Owner and/or Engineer may document geomembrane installation including panel placement, seaming, pre-qualification seam testing, non-destructive seam and repair testing, repair size and locations, and weather conditions.
    3. The Owner may engage and pay for the services of Engineer and QA Laboratory to monitor geomembrane installation.

#### 1.05 SUBMITTALS

- A. Prior to project start, submit the following to Owner and/or Engineer in accordance with Section 01300, Submittals:
  1. Raw Materials:

- a. Name of Resin Supplier, location of supplier's production plant(s), resin brand name and product number.
  - b. Source and nature of plasticizers, fillers, carbon black and any other additives along with their percent addition to geomembrane material.
  - c. Test results documenting conformance with the "index properties" of GRI Test Method, GM 13.
2. Geomembrane Manufacturer's Certification:
- a. Written certification that Geomembrane Manufacturer's Quality Control Plan was fully implemented during production of geomembrane material supplied for this project. (Submittal shall be made within 5 working days of delivery to site).
3. Geomembrane Manufacturer Production Information:
- a. Corporate background information indicating compliance with qualification requirements.
  - b. Quality control plan for manufacturing.
  - c. Copy of quality control certificates demonstrating compliance with the quality control plan for manufacturing and the test property requirements of GRI Test method, GM 13 (i.e., mill certificates).
4. Contractor shall provide the Engineer a certificate stating the name of the geotextile manufacturer, product name, chemical composition of the filaments and other pertinent information to fully describe the geotextile.
5. Geomembrane Installer's Seaming Personnel
- a. Corporate background information indicating compliance with qualification requirements.
  - b. Training completed by personnel.
  - c. Seaming experience for each personnel.
6. Geomembrane Installer's Information:
- a. Corporate background information indicating compliance with qualification requirements.
  - b. List of completed facilities, totaling 5,000,000 square feet minimum for which Geomembrane Installer has completed installation of a HDPE geomembrane. Include name and purpose of facility, location, date of installation, and quantity installed.

- c. Resumes of personnel performing field seaming operation, along with pertinent experience information. Include documentation regarding which seamers are qualified to use thermal fusion welding apparatus.
    - d. Installation quality control plan.
  - 7. Installation panel layout diagram identifying placement of geomembrane panels, seams, and any variance or additional details which deviate from Contract Drawings or Technical Specifications. Layout shall be drawn to scale and shall be adequate for use as a construction plan. Layout shall include dimensions and pertinent seam and anchorage details.
  - 8. Installation Sequence and Schedule shall be included as part of Construction Progress Schedule.
  - 9. Description of seaming apparatus to be used indicating compliance with specified requirements.
- B. With bid, submit the following to Owner and/or Engineer in accordance with Section 01300, Submittals
  - 1. Leak Location Contractor's Work Plan:
    - a. Corporate background information indicating compliance with qualification requirements.
    - b. List of completed facilities, totaling 2,000,000 square feet minimum of geomembrane leak location surveys on some combination of at least 5 completed facilities. Include name and purpose of facility, location, date of survey, survey method, and quantity surveyed.
    - c. Resumes of personnel performing leak location survey, along with pertinent experience information.
    - d. Leak Location Contractor quality control plan including description of the proposed survey methods and procedures, and field calibration procedures.
    - e. Leak Location Contractor's required site preparations to be completed to perform the proposed leak location survey, and estimated duration to complete the survey.
    - f. An example of a final report (per ASTM D 7007) provided by the Leak Location Contractor following the completion of the survey.
- C. During installation, submit the following to the Owner and/or Engineer:
  - 1. Daily records/logs prepared by Geomembrane Installer documenting work performed, personnel involved, general working conditions, and any problems encountered or anticipated on project. Submit on a weekly basis.

2. Copy of subgrade acceptance signed by Geomembrane Installer for areas to be covered with geomembrane each day.
- D. Within 10 days of geomembrane installation completion, submit the following to Owner and/or Engineer:
1. Geomembrane installation certification that Work was performed under Geomembrane Installer's approved quality control plan and in substantial compliance with Technical Specifications and Contract Drawings.
  2. As-built panel diagram identifying placement of geomembrane panels, seams, repairs, and destructive seam sample locations.
  3. Copy of warranty for material (including factory seams) and installation covering both for a period of 2 years from the date of substantial completion.
- E. The Owner and/or Engineer will review and inspect geomembrane installation upon completion of all Work specified in this Section. Deficiencies noted shall be corrected at no additional cost to the Owner.
- F. The Owner and/or Engineer will provide written final acceptance of the geomembrane installation after completion of the leak location survey. Written conditional geomembrane installation acceptance can be provided to the Contractor prior to completion of the leak location survey when the following conditions are satisfied, if necessary, and requested by the Contractor:
1. The entire geomembrane installation is completed or any pre-determined subsection if the project is phased.
  2. All installation quality assurance/control documentation has been completed and submitted to the Owner and/or Engineer.
  3. Verification of the adequacy of all field seams, repairs and associated testing is complete.
- G. Within 14 days of completion of the leak location survey, submit final written report (per ASTM D 7007) of the leak location survey provided by Leak Location Contractor.

1.06 DELIVERY, STORAGE, AND HANDLING

- A. Transportation:
1. Geomembrane rolls shall be transported, unloaded and handled at the job site in accordance with manufacturer recommendations. Damaged material may be rejected by the Owner and/or Engineer. Manufacturer packaging shall be labeled in accordance with Section 02700, 2.02G.

- B. On-site Storage:
1. Geomembrane rolls which have been delivered to job site shall be unloaded and stored in original, unopened packaging in a secure location, determined by Owner and/or Engineer.
  2. Store geomembrane rolls to ensure adequate protection against exposure to the following:
    - a. Equipment;
    - b. Strong oxidizing chemicals, acids, or bases;
    - c. Flames, including welding sparks;
    - d. Temperatures in excess of 160 deg. F;
    - e. Dust;
    - f. Ultraviolet radiation (i.e. sunlight); and
    - g. Inclement weather.
  3. Whenever possible, provide a 6-inch minimum air space between rolls.
  4. Containers/rolls shall not be stacked.
- C. On-Site Handling:
1. Handle rolls per Geomembrane Manufacturer's recommendations and as necessary to prevent damage.

## PART 2 - PRODUCTS

### 2.01 MATERIALS

- A. Geotextile to be used for cushioning between subgrade and geomembrane shall be polyester or polypropylene, non-woven needlepunched fabric and shall conform to the following requirements:

#### GEOTEXTILE PROPERTIES

<b>Property</b>	<b>Units</b>	<b>Value</b>	<b>Test</b>	<b>Criterion</b>
Mass Per Unit Area	oz/yd <sup>2</sup>	16	ASTM D5261	MARV
Puncture Strength	lb	170	ASTM D4833	MARV
Trapezoid Tear	lb	145	ASTM D4533	MARV
Grab Tensile Strength	lb	370	ASTM D4632	MARV
Grab Elongation	%	50	ASTM D4632	MARV
UV Resistance @500 hours	% retained	70	ASTM D4355	Minimum

- B. Geotextile to be used for separation between geomembrane and sand material shall be polyester or polypropylene, non-woven needlepunched fabric and shall conform to the following requirements:

#### GEOTEXTILE PROPERTIES

<b>Property</b>	<b>Units</b>	<b>Value</b>	<b>Test</b>	<b>Criterion</b>
Mass Per Unit Area	oz/yd <sup>2</sup>	12	ASTM D5261	MARV
Apparent Opening Size	US Sieve	100	ASTM D4751	MARV
Puncture Strength	lb	210	ASTM D4833	MARV
Trapezoid Tear	lb	125	ASTM D4533	MARV
Grab Tensile Strength	lb	320	ASTM D4632	MARV
Grab Elongation	%	50	ASTM D4632	MARV
UV Resistance @500 hours	% retained	70	ASTM D4355	Minimum

- C. High Density Polyethylene (HDPE) White Textured Geomembrane

1. HDPE geomembrane shall be white, textured (both sides), 60-mil product approved by the Owner and/or Engineer.
2. The Contractor shall submit, with the bid, written certification from the proposed Geomembrane Manufacturer that geomembrane products proposed in the bid satisfy the following requirements:
  - a. The proposed Geomembrane Manufacturer shall have a minimum of 5 years of continuous experience manufacturing HDPE geomembrane totaling 1,000,000 square feet.
  - b. The proposed HDPE compound shall be comprised entirely of virgin materials. Compliance with this specification shall be documented in accordance with Geomembrane Manufacturer's quality control program and submitted to the Owner and/or Engineer with the written conformance certification.
  - c. The proposed Geomembrane Manufacturer shall certify that any plasticizers, fillers and additives incorporated into the manufacturing process for the proposed HDPE geomembrane have demonstrated acceptable performance on past projects.
  - d. The proposed geomembrane shall meet the requirements of Geosynthetic Research Institute's test method GM 13.
  - e. The nominal thickness of proposed geomembrane shall be 60 mil., or as approved by the Owner and/or Engineer.
3. Geomembrane sheets shall be visually consistent in appearance and shall contain no holes, blisters, undisbursed raw materials or other signs of contamination by foreign material. Geomembrane must have no striations, roughness or bubbles on the surface.

B. Seaming Apparatus

1. Thermal fusion welding machines used for joining geomembrane surfaces may be either extrusion or hot wedge. These machines shall include sufficient temperature and rate-of-travel monitoring devices to allow continuous monitoring of operating conditions.
2. One spare, operable thermal fusion seaming device shall be maintained on site at all times.

C. Field Test Equipment

1. Field Tensiometer: the field tensiometer shall be calibrated within three months prior to project start date over the range of field test values.
2. Air Channel Test Equipment: air channel test equipment shall consist of hoses, fittings, valves and pressure gauge(s) needed to deliver and monitor the pressure of compressed air through an approved pressure feed device.
3. Air Compressor: the air compressor utilized for field testing shall be capable of producing and maintaining an operating pressure of at least 50 psi.
4. Vacuum Box: the vacuum box shall consist of a vacuum gage, valve, and a gasket around the edge of the open bottom needed to apply vacuum to a surface.

2.02. CONFORMANCE TESTING REQUIREMENTS

A. Geomembrane shipped to site shall undergo conformance testing. Manufacturer's roll certificates may be used for conformance evaluation at the option of the Owner and/or Engineer. Nonconforming material shall either be retested at the direction of the Owner and/or Engineer or removed from site and replaced at Contractor's expense.

B. Conformance Test Methods

1. Samples will be located and collected by the Owner and/or Engineer at a rate of one sample per 100,000 square feet of geomembrane delivered to site.
2. One sample will be obtained from each geomembrane production batch delivered to the site.
3. Samples shall be cut by Geomembrane Installer and be at least 45 square feet in size.
4. Samples shall be tested in accordance with Table 1 (Smooth) or Table 2 (Textured) specified in GRI Test Method GM13.
5. Geomembrane thickness shall be measured a minimum of three times per panel during deployment to verify conformance with GRI Test Method GM13.

C. Role of Testing Laboratories

1. The Owner and/or Engineer will be responsible for acquiring samples of the geomembrane for conformance testing. The Owner or Engineer will retain an independent, third party laboratory to perform conformance testing on samples of geomembrane.
2. Retesting of geomembrane panels by the Geomembrane Installer because of failure to meet any of the conformance specifications can only be authorized by the Owner and/or Engineer. Non-conforming panels may be retested in accordance with Subsection 2.03(B) and 2.03(D) under authorization of the Owner and/or Engineer.
3. The Geomembrane Manufacturer and/or Geomembrane Installer may perform independent tests in accordance with methods and procedures specified in Subsection 2.03(B). Results shall not be substituted for quality assurance testing described herein.

D. Procedures for Determining Conformance Test Failures

1. If conformance test results fail to meet specifications, the roll and/or batch may be retested using specimens from either the original roll sample or from another sample collected by the Owner and/or Engineer. Two additional tests (retests) shall be performed for each failed test procedure. Each retest shall consist of multiple specimen tests if multiple specimens are specified in the test procedure. If the results of both retests meet specifications, the roll and batch will be considered to have passed conformance testing.
2. Failure of any retest shall be cause for rejection of the entire roll or batch depending on the type of failing test. The Owner and/or Engineer reserves the right to collect samples from other roll of a particular batch for further conformance testing. The Owner and/or Engineer may choose to accept only a portion of the batch on the basis of the results of conformance testing of samples collected from other rolls.
3. If retesting does not result in conformance with the specifications as defined in preceding paragraph, or if there are any other nonconformities with the material specifications, the Contractor shall remove the rolls from use in project. The Contractor shall also be responsible for removal of rejected geomembrane from the site and replacement with acceptable geomembrane at no additional cost to the Owner.



**PART 3 - EXECUTION**

**3.01 PRE-CONSTRUCTION MEETING**

- A. A Pre-Construction Meeting shall be held at the site in accordance with Section 01040, Project Administration, to discuss and plan the details of geomembrane installation. This meeting shall be attended by the Geomembrane Installer, Owner, Engineer and the Contractor.
- B. The following topics relating to geomembrane installation shall be addressed:
  - 1. Responsibilities of each party.
  - 2. Lines of authority and communication.
  - 3. Methods for documenting, reporting and distributing documents and reports.
  - 4. Procedures for packaging and storing archive samples.
  - 5. Review of the schedule for all installation and quality assurance testing, including third-party testing turnaround times.
  - 6. Review of panel layout, access and numbering systems for panels and seams including details for marking on the HDPE geomembrane.
  - 7. Procedures and responsibilities for preparation and submittal of as-built drawings.
  - 8. Temperature and weather limitations, installation procedures for adverse weather conditions and defining acceptable subgrade or ambient moisture and temperature conditions for working during liner installation.
  - 9. Subgrade conditions, dewatering responsibilities and subgrade maintenance plan.
  - 10. Deployment techniques including allowable subgrade for geomembrane.
  - 11. Procedures for covering of the geomembrane to prevent damage.
  - 12. Plan for minimizing wrinkles in the geomembrane.
  - 13. Measurement and payment schedules.
  - 14. Site health and safety procedures/protocols.

**3.02 SUBGRADE PREPARATION**

- A. The Geomembrane Installer shall visually inspect the subgrade immediately prior to geomembrane deployment. Inspection shall verify that there are no potentially harmful foreign objects present, such as sharp rocks and other deleterious debris. Any foreign objects encountered shall be removed by Geomembrane Installer or Contractor. All subgrade damaged by construction equipment and deemed unsuitable for geomembrane

deployment shall be repaired prior to geomembrane deployment. All repairs shall be approved by the Owner and/or Engineer and Geomembrane Installer. The responsibility for preparation, repairs, and maintenance of the subgrade shall be defined in the preconstruction meeting. The Geomembrane Installer shall provide the Owner and/or Engineer with written acceptance of subgrade surface over which 16 oz non woven geotextile and geomembrane is deployed (Part 1 .05B) for each day of deployment.

3.03 GEOMEMBRANE LINER DEPLOYMENT

- A. Geomembrane Installer shall deploy 16-oz non woven geotextile following applicable certifications/quality control certificates listed in subsection 1.05 of this section and conformance testing in subsection 2.02 or this section are submitted and approved by the Owner and/or Engineer. Any 16-oz non woven geotextile placed prior to approval by the Owner and/or Engineer shall be at the sole risk of the Contractor. If geotextile installed prior to approval by the Owner and/or Engineer does not meet the requirements of this specification, it shall be removed from the site at no additional cost to the Owner.
- B. Geomembrane will be deployed following installation of 16-oz non woven geotextile according to submitted panel layout drawing as approved by the Owner and/or Engineer. The Owner and/or Engineer is to be notified of and approve any revisions or modifications to the approved panel layout drawing prior to deploying geomembrane in the area of review.
- C. Adequate temporary anchoring (sand bags, tires, etc.) that will not damage the geomembrane shall be placed on a deployed panel to prevent uplift by wind.
- D. Geomembrane shall not be deployed if:
  - 1. Ambient temperatures are below 41 degrees F (5 degrees C) or above 104 degrees F (40 degrees C) measured six inches above geomembrane surface unless approved by the Owner and/or Engineer.
  - 2. Precipitation is expected or in the presence of excessive moisture or ponded water on the subgrade surface.
  - 3. Winds are excessive as determined by Geomembrane Installer in agreement with the Owner and/or Engineer.
  - 4. The Owner and/or Engineer will have the authority to suspend work during such conditions.
- E. The Geomembrane Installer shall be responsible for conformance with the following requirements:
  - 1. Equipment utilized for installation/quality assurance testing does not damage geomembrane. Such equipment shall have rubber tires and a ground pressure not exceeding 5 psi or total weight exceeding 750 lbs. Only equipment necessary for installation and quality assurance testing is allowed on the deployed geomembrane.

2. Personnel working on geomembrane do not damage geomembrane (activities such as smoking or wearing damaging clothing shall not be allowed).
  3. Method of deployment does not damage geomembrane.
  4. Method of deployment minimizes wrinkles.
  5. Temporary loading or anchoring does not damage geomembrane.
  6. Direct contact with geomembrane is minimized.
- F. Geomembrane Installer shall place 12-oz non woven geotextile on the geomembrane at the base of the impoundment and at least 4 feet up side slopes, as indicated on Contract Drawings. Geomembrane Install shall cover the inlet apron batten bar attachment with the 12-oz non woven geotextile.
- G. No vehicles shall be allowed on deployed geomembrane under any circumstances.

### 3.04 FIELD SEAMS

#### A. Seam Layout

1. In general, seams shall be oriented parallel to the line of the maximum slope. In corners and at other odd-shaped geometric intersections, number of seams should be minimized. If at all possible, seams shall not be located at low points in the subgrade unless geometry requires seaming to be done at these locations.
2. A seam numbering system compatible with the panel numbering system shall be agreed upon at the Pre-Construction Meeting.

#### B. Seaming Processes/Equipment

1. Approved processes for field seaming (panel to panel) are extrusion or hot wedge fusion-type seam methods. No other processes can be used without prior written authorization from the Owner and/or Engineer. Only equipment which has been specifically approved by make and model shall be used, if applicable.
3. The Geomembrane Installer will meet following requirements regarding use, availability, and cleaning of welding equipment at job site:
  - a. Intersecting hot wedge seams shall be patched using extrusion welding process.
  - b. Electric generator for equipment shall be placed on a smooth base such that no damage occurs to geomembrane. A smooth insulating plate or fabric shall be placed beneath hot equipment after usage.
3. The Geomembrane Installer shall keep records for performance and testing of all seams.

C. Seaming Requirements/Procedures

1. Weather Conditions - Range of weather conditions under which geomembrane seaming can be performed are as follows:
  - a. Unless otherwise authorized in writing by Owner and/or Engineer, no seaming shall be attempted or performed at an ambient temperature below 41 degrees F (5 degrees C) or above 104 degrees F (40 degrees C).
  - b. Between ambient temperatures of 32 degrees F (0 degrees C) and 41 degrees F (5 degrees C), seaming shall be performed only if geomembrane is preheated by either sun or a hot air device, provided there is no excessive ambient cooling resulting from high winds. Pre-qualification seams shall be produced under identical conditions.
  - c. Above 41 degrees F (5 degrees C), no preheating of geomembrane will be required.
  - d. Geomembrane shall be dry and protected from wind.
  - e. Seaming shall not be performed during any precipitation event.
  - f. Seaming shall not be performed in areas where ponded water has collected below surface of geomembrane.
2. If the Geomembrane Installer chooses to use methods which may allow seaming at ambient temperatures below 41 degrees F or above 104 degrees F, the Geomembrane Installer shall demonstrate and submit certification to Owner and/or Engineer that methods and techniques used to perform seaming produce seams that are equivalent to seams produced at temperatures above 41 degrees F and below 104 degrees F. The Owner and/or Engineer may deny approval for use of the proposed technique regardless of demonstration results.
3. Overlapping - Geomembrane panels shall have finished overlap as follows:
  - a. Minimum of 6 inches for thermal fusion welding.
  - b. Insufficient overlap will be considered a failed seam.
4. Pre-qualification tests for geomembrane fusion welding shall be conducted by a minimum of 2 pre-qualification seams conducted per day per welding machine by each seaming technician performing welding with that machine. At least one test shall be performed at the start of each work day, with tests at intervals of no greater than 5 hours and additional pre-qualification tests following work interruptions, weather changes, changes to machine settings, or as directed by the Owner and/or Engineer. Pre-qualification seams shall be made under the same conditions as the actual seams.

- a. Pre-qualification seam samples shall be 5 feet long by 1-foot wide (minimum) after seaming, with seam centered along its length. Each pre-qualification seam shall be labeled with the date, geomembrane temperature, seaming unit identifier, seam number or test location, technician performing the test seam and description of testing results.
- b. Seam overlap shall be in accordance with subsection 3.04(C)(3).
- c. Pre-qualification seams shall be inspected for proper squeeze-out, footprint pressure, and general appearance.
- d. Four specimens, each 1-inch in length, shall be cut from opposite ends of the pre-qualification seam sample by the Geomembrane Installer. The remainder of pre-qualification seam shall be retained by the Owner and/or Engineer and may be submitted for laboratory testing.
- e. The Geomembrane Installer shall complete two shear tests and two peel tests.
- f. Pre-qualification seams failed by inspection or testing may be retested at request of the Geomembrane Installer. If the second pre-qualification seam fails, then the seaming apparatus or seaming technique shall be disqualified from use until two consecutive, satisfactory pre-qualification seams are obtained.

5. Seam Preparation

- a. Prior to seaming, seam area shall be clean and free of moisture, dust, dirt, debris of any kind, and foreign material.
- b. Seams shall be aligned so as to minimize number of wrinkles and fishmouths.

6. General Seaming Procedures

- a. Fishmouths or wrinkles at seam overlaps shall be cut along ridge of the wrinkle to achieve a flat overlap. Cut fishmouths or wrinkles shall be repaired, and/or patched in accordance with Part 3.07.
- b. Seaming shall extend to the outside edge of geomembrane panels including material placed in anchor trenches.
- c. For cross seams, the intersecting thermal fusion seams shall be patched using the extrusion welding process.

3.05 NON-DESTRUCTIVE TESTING

- A. Each field seam shall be non-destructively tested over its entire length by the Installer. Testing shall be conducted as field seaming progresses, not at completion of all seams, unless specifically agreed to by the Owner and/or Engineer in writing.

- B. Vacuum Testing – shall be performed in accordance with ASTM D5641, Standard Practice for Geomembrane Seam Evaluation by Vacuum Chamber.
- C. Air Pressure Testing – shall be performed in accordance with ASTM D5820, Standard Practice for Pressurized Air Channel Evaluation of Dual Seamed Geomembranes, and GRI GM 6, Pressurized Air Channel Test for Dual Seamed Geomembranes.
- D. Each seam tested non-destructively shall be marked with the date of the test, name of the testing technician, length of the seam, test method and results. The same shall also be recorded by the Owner and/or Engineer on the appropriate CQA documentation.
- E. Non-Destructive Seam Test Failures
  - 1. Seams failing non-destructive testing shall be repaired by the Geomembrane Installer according to Part 3.07. Seams shall be non-destructively retested. If the seam defect cannot be located, the entire section of seams affected shall be repaired and retested.

### 3.06 ELECTRONIC LEAK LOCATION SURVEY

- A. Leak Location Contractor shall identify actions required by Contractor to prepare the site for the leak location survey.
- B. Contractor shall ensure that the sand and warning layers, and 12 oz non woven geotextile above and 16 oz non woven geotextile below the geomembrane contains sufficient moisture to conduct a leak location survey. Typically, a moisture content of earth materials of 1% to 2% by weight is sufficient to conduct the survey. If the moisture content of the sand layer, warning layer and subgrade is not sufficient per the requirements of the Leak Location Contractor, Contractor shall add sufficient water the layers, as required.
- C. Contractor shall provide electrical isolation of the metal marker posts, batten bars, and concrete structures, as requested by Leak Location Contractor.
- D. Leak Location Contractor shall inspect the site prior to commencing the survey to ensure all site preparations are completed and the site conditions are appropriate for conducting the leak location survey.
- E. Any discrepancy in the required site preparation detailed in the Leak Location Contractor's Work Plan or site conditions shall be reported to the Contractor for corrective or appropriate action.
- F. After the warning layer is placed, conduct a leak location survey on the warning layer material using the procedures for surveys with earth materials covering the Geomembrane as described in ASTM D 7007.
- G. A leak detection sensitivity test using an artificial leak shall be conducted on the geomembrane for each set of equipment used before the equipment is used on for the leak location survey, as described in ASTM D 7007 to determine the detection distance for the survey.

- H. The leak location survey shall be taken on survey lines or on a grid spaced no farther apart than twice the leak detection distance as determined in the leak detection sensitivity test.
- I. The Leak Location Contractor shall inform the Owner and/or Engineer and mark the locations of all identified or indicated leaks with a flag or spray paint. The Geomembrane Installer shall repair the defect/hole as detailed in Part 3.08 of this Section.

### 3.07 DEFECTS AND REPAIRS

- A. The geomembrane shall be examined by the Geomembrane Installer and the Owner and/or Engineer for defects, holes, blisters, undispersed raw materials, and any signs of contamination by foreign matter. The geomembrane surface shall be swept and/or washed by the Geomembrane Installer if the amount of dust or mud inhibits examination. The Contractor shall provide a water truck, an operator, clean water and hoses as reasonably necessary to assist the Geomembrane Installer in this activity.
- B. Portions of geomembrane exhibiting flaws, or failing a non-destructive or destructive (if conducted) test, shall be repaired or replaced by the Geomembrane Installer. Repair procedures available include:
  - 1. Patching - used to repair large holes, tears, undispersed raw materials, contamination by foreign matter, holes resulting from destructive sampling (if conducted), and locations where seam overlap is insufficient;
  - 2. Capping - used to repair large lengths of failed seams; and
  - 3. Additional Procedures - used upon recommendation of the Geomembrane Installer if agreed to by the Owner and/or Engineer.
- C. Patches or caps.
  - 1. Extend patch or cap 6 inches (minimum) beyond the edge of the defect.
  - 2. Round corners of patch and/or cap (suggest 3-inch radius).
  - 3. Repair procedures, equipment, materials, and techniques will be approved by the Owner and/or Engineer prior to repair.
  - 4. Geomembrane below large caps shall be appropriately cut to avoid water or gas collection between two sheets.
- D. The Geomembrane Installer shall mark on the geomembrane (using a non-puncturing writing utensil), repair date, time, and personnel involved.
- E. Each repair shall be non-destructively tested in accordance with Part 3.05. Large caps may require destructive test sampling at the discretion of the Owner and/or Engineer (in accordance with Part 3.06).

- F. Repairs which fail testing shall be redone and retested until a passing result is obtained. The Geomembrane Installer will perform non-destructive testing or repairs and will document retesting of repairs.
- G. The Owner and/or Engineer will document repairs, repair testing, and retesting results.
- H. The Geomembrane Installer shall cut and seam wrinkles which may adversely affect long-term integrity of the geomembrane, hinder subsequent construction of overlying layers, or impede drainage off of the geomembrane after it is covered by soil. Seaming shall be done in accordance with procedures described in Parts 3.04(B) and 3.04(C), and it shall be subject to test provisions of Parts 3.05 (non-destructive testing) and 3.06 (destructive testing – if conducted).

### 3.08 PROTRUSIONS AND CONNECTIONS TO GEOMEMBRANE

- A. If required, the Geomembrane Installer shall install geomembrane around utility poles, guy wires, and other structures according to the Contract Drawings and the following requirements:
  - 1. Use minimum 2-ft long membrane pipe boots and steel straps to seal the geomembrane around pole or structure.
  - 2. Use standard welding procedures to seam the membrane boot to the geomembrane.
  - 3. Seaming performed on and around penetrations, and other appurtenances shall be non-destructively tested using the vacuum testing method.

### 3.09 SURVEY DOCUMENTATION

- A. Prior to covering the geomembrane, the Geomembrane Installer shall provide the Contractor, Owner and/or Engineer with 24-hour notification to conduct a survey. The Contractor shall survey the location of all seams (panel corners acceptable), and repairs. The Contractor shall provide survey data to the Owner and/or Engineer within one working day of survey completion and in accordance with Section 01050.

### 3.10 DAILY FIELD INSTALLATION REPORTS

- A. At the beginning of each day, the Geomembrane Installer shall provide the Owner and/or Engineer with a report for all work completed the previous day.
- B. The Daily Field Installation Report shall include the following:
  - 1. The total amount and location of geomembrane placed.
  - 2. The total length and location of seams completed, technician name and welding unit numbers.
  - 3. A drawing or sketch depicting the geomembrane installed the previous day including the panel number, seam number and locations of non-destructive and destructive testing (if conducted).



4. Results of pre-qualification test seams, if available.
  5. Results of non-destructive testing.
- C. Destructive test results (if conducted) shall be reported within 48 hours or prior to covering the geomembrane, whichever is practical.

**END OF SECTION**

## TABLE OF CONTENTS

---

### INTRODUCTORY PAGE

Section 00001 – Specification Data Sheet .....	00001-1 to 1
--	--------------

### DIVISION 1 - GENERAL REQUIREMENTS

Section 01010 – Summary of Work .....	01010-1 to 3
Section 01015 – General Requirements .....	01015-1 to 3
Section 01040 – Project Administration .....	01040-1 to 5
Section 01050 – Field Engineering and Surveying .....	01050-1 to 2
Section 01300 – Submittals .....	01300-1 to 2
Section 01400 – Quality Assurance and Control .....	01400-1 to 2
Section 01500 – Construction Facilities and Temporary Controls.....	01500-1 to 7
Section 01700 – Project Closeout .....	01700-1 to 2

### DIVISION 2 - SITE WORK

Section 02300 – Earthwork .....	02300-1 to 11
Section 02600 – HDPE Geomembrane .....	02600-1 to 19

### FIGURES

Figure 1	Site Location Map (1862-A01C)
----------	-------------------------------

### TABLES

Table 1	List of Documentation Surveys
Table 2	List of Submittals

### SHEETS

TS	Title Sheet (D1862-TS-00)
C010	Existing Conditions (D1862 C010-01)
C020	Liner Subgrade Preparation (D1862 C020-01)
C030	Warning Layer Plan (D1862 C030-01)
C031	Details and Sections (D1743 C031-01)

**FIGURES**

**FIGURE**

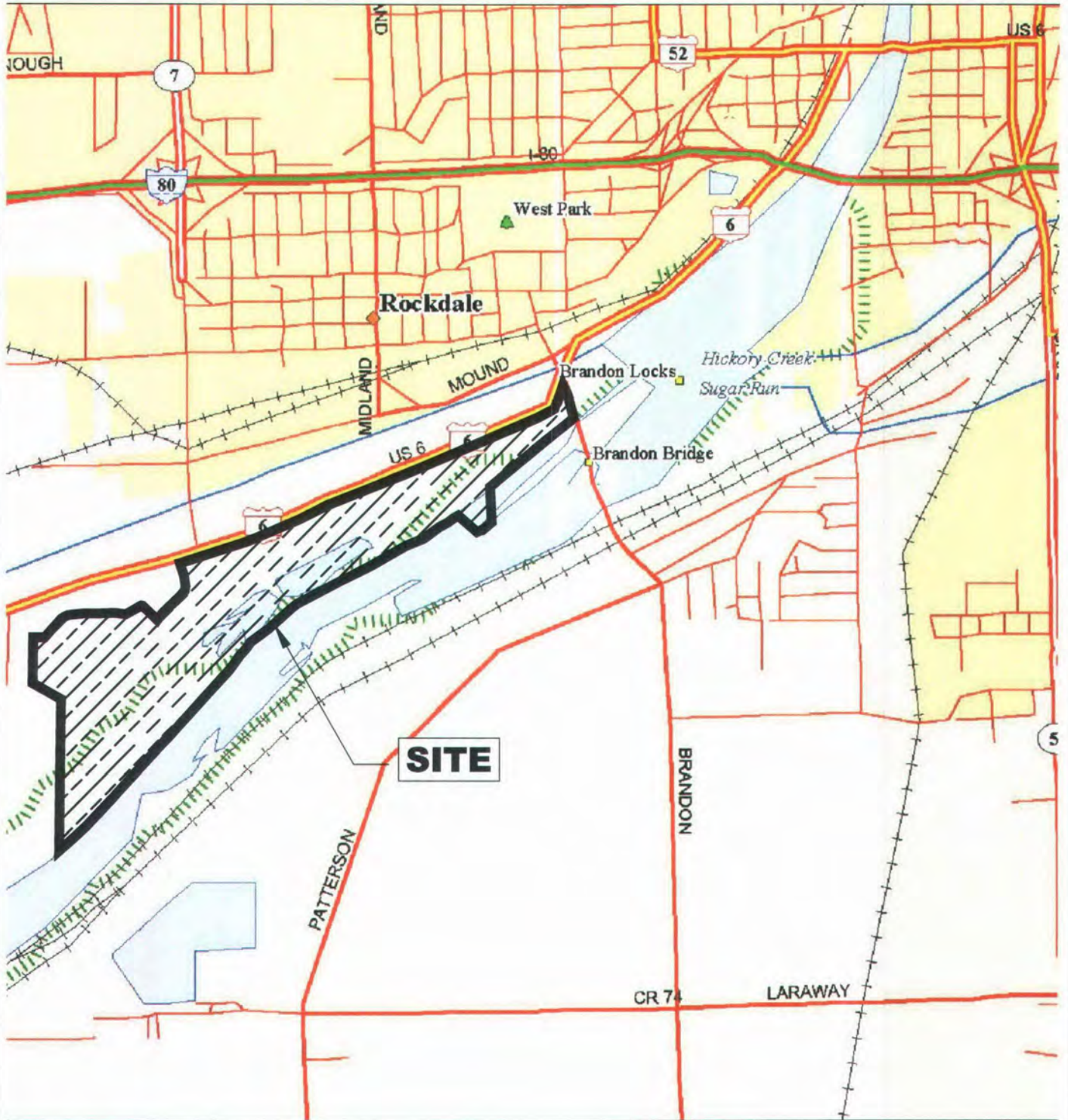

SOURCE: DELORME MAP EXPERT (TM)  
 VERSION 2.0  
 COPYRIGHT 1993, DELORME MAPPING  
 JOLIET. DATED 1993.

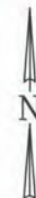

0 2000 4000



SCALE IN FEET

### SITE LOCATION MAP

MIDWEST GENERATION  
 JOLIET STATION NO. 29  
 JOLIET, ILLINOIS

PROJECT NO.  
 1862

DRAWING NO.  
 1862-A01C

FIGURE NO.  
 1



DRAWN BY: BJK 05/08/07 APP'D BY: HMS DATE: 06/04/07



**TABLES**

**Table 1. List of Documentation Surveys**  
**Ash Impoundment #2 Liner Replacement Specifications**  
**Midwest Generation – Joliet 29**

Survey	Responsible Party	Frequency	Technical Specification Reference
Location of anchor trench alignment	Contractor	Every 25 ft intervals	Section 01050, 1.02B
Location and elevation geomembrane panels	Contractor	At panel corners and repairs, as necessary	Section 01050, 1.02C Section 02600, 1.05C, 3.10A
Location of marker post	Contractor	As necessary	Section 01050, 1.02E
Topographic survey of warning layer	Contractor	50 ft square grid and at grade changes	Section 01050, 1.02F

Notes

1. Contractor shall provide Owner and/or Engineer results of survey within 2 working days after completion.
2. Owner and/or Engineer acceptance or rejection will be provided within 2 working days following receipt of documentation survey.



**Table 2 - List of Submittals**  
**Ash Impoundment #2 Liner Replacement Specifications**  
**Midwest Generation – Joliet 29**

	Submittal	From	To	Time Frame	Reviewer	Technical Specification	
						Section	Part
1	Subcontractor List	Contractor	Owner and/or Engineer	With bid documents	Owner	01040	1.03F
2	Baseline Construction Schedule	Contractor	Owner and/or Engineer	With bid documents and update within 10 calendar days of the date of the Contract award	Owner and/or Engineer	01040	1.06B
3	Earthwork Plan	Contractor	Owner and/or Engineer	With bid documents	Owner and/or Engineer	02300	1.06B
4	Name and Location of Recycling / Disposal Facility	Contractor	Owner and/or Engineer	With bid documents	Owner and/or Engineer	02300	1.06E
5	Leak Location Contractor's Work Plan	Contractor	Owner and/or Engineer	With bid documents	Owner and/or Engineer	02600	1.05B
6	Construction Start Date	Contractor	Owner and/or Engineer	5 Working days prior to construction start	Owner and/or Engineer	02300	1.06D
7	IEPA Water Pollution Control Construcion Permit	Owner through Engineer	Contractor	Prior to project start	Contractor	01015	1.05A
8	Site Superintendent/Foreman's Name & Phone Number	Contractor	Owner and/or Engineer	Prior to project start	Owner and/or Engineer	01040	1.03A
9	Location of Off-site Fill Material Sources	Contractor	Owner and/or Engineer	Prior to project start	Owner and/or Engineer	02300	1.06C
10	Off-site Fill Material Certificates/Test Results	Contractor	Owner and/or Engineer	Prior to project start	Owner and/or Engineer	02300	1.06E
11	Resin Supplier, Address, Brand Name, Product Number and Test Results	Contractor	Owner and/or Engineer	Prior to project start	Owner and/or Engineer	02600	1.05A
12	Source and nature of additives	Contractor	Owner and/or Engineer	Prior to project start	Owner and/or Engineer	02600	1.05A
13	Geomembrane Installer's Information, Layout Diagram, Schedule, Seaming Equipment	Contractor	Owner and/or Engineer	Prior to project start	Owner and/or Engineer	02600	1.05A

**Table 2 - List of Submittals**  
**Ash Impoundment #2 Liner Replacement Specifications**  
**Midwest Generation – Joliet 29**

	Submittal	From	To	Time Frame	Reviewer	Technical Specification	
						Section	Part
14	Progress Meeting Minutes	Owner and/or Engineer	Owner, Contractor, Engineer, and Subcontractors (as necessary)	Prior to subsequent progress meeting	Owner and/or Engineer	01040	1.05E
15	Progress Schedule	Contractor	Owner and/or Engineer	Weekly one working day prior to regular scheduled progress meeting	Owner and/or Engineer	01040	1.06C 1.06D
16	Progress Reports	Contractor	Owner and/or Engineer	Weekly one working day prior to regular scheduled progress meeting	Owner and/or Engineer	01040	1.08A
17	Accident Reports, Work Stoppage/Dispute Records, Contractor Invoices, Schedule of Values, Test Report Records, and Equipment Check Records	Contractor	Owner and/or Engineer	As Necessary	Owner and/or Engineer	01040	1.08B
18	Sand Material Representative Sample	Contractor	Owner and/or Engineer	Two weeks prior to delivery	Owner and/or Engineer	02300	2.03
19	Warning Layer Representative Sample	Contractor	Owner and/or Engineer	Two weeks prior to delivery	Owner and/or Engineer	02300	2.04
20	Geomembrane Manufacturer's Certification-PGI Standards	Contractor	Owner and/or Engineer	5 working days prior to delivery to site	Owner and/or Engineer	02600	1.05A
21	Geotextile - Product Information	Contractor	Owner and/or Engineer	5 working days prior to delivery to site	Owner and/or Engineer	02600	1.05A
22	Geomembrane Manufacturer's Certification - Product Information	Contractor	Owner and/or Engineer	5 working days prior to delivery to site	Owner and/or Engineer	2600	1.05A
23	Certification of Geomembrane Manufacturer's Quality Control Plan	Contractor	Owner and/or Engineer	5 working days prior to delivery to site	Owner and/or Engineer	2600	1.05A

**Table 2 - List of Submittals**  
**Ash Impoundment #2 Liner Replacement Specifications**  
**Midwest Generation – Joliet 29**

	Submittal	From	To	Time Frame	Reviewer	Technical Specification	
						Section	Part
24	Geomembrane Installer's Daily Logs and Quality Control Documentation	Contractor	Owner and/or Engineer	During geomembrane installation	Owner and/or Engineer	02600	1.05C
25	Geomembrane Installer's Subgrade Acceptance	Contractor	Owner and/or Engineer	Each day prior to geomembrane installation	Owner and/or Engineer	02600	1.05C 3.02A
26	Geomembrane Installation Certificate, As-Builts, and Warranties	Contractor	Owner and/or Engineer	Within 10 working days of geomembrane installation completion	Owner and/or Engineer	02600	1.05D
27	Written Certification for Project	Contractor	Owner and/or Engineer	Upon completion of work	Owner and/or Engineer	01700	1.03B & C
28	Conditional and/or Final Geomembrane Installation Acceptance	Owner and/or Engineer	Contractor	Upon completion of geomembrane installation and submittals	Contractor	2600	1.05F
29	Record Documents	Contractor	Owner and/or Engineer	Prior to submittal of final invoice	Owner and/or Engineer	01700	1.04
30	Survey Data	Contractor	Owner and/or Engineer	Within 4 days following completion of survey	Owner and/or Engineer	01050	1.05
31	Final Leak Location Survey Report	Contractor	Owner and/or Engineer	Within 14 days following completion of leak location survey	Owner and/or Engineer	02600	1.05G



# ASBUILT OF MIDWEST GENERATION JOLIET 29 POWER PLANT WEST-ASH IMPOUNDMENTS

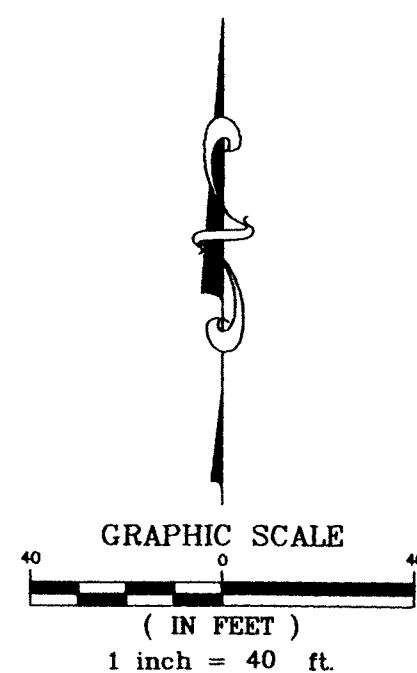

**LEGEND**

- meo. MEASURED
- rec. RECORDED
- calc. CALCULATED
- FOUND SURVEY MONUMENT
- SET 5/8" REBAR UNLESS OTHERWISE NOTED
- 6' HIGH CHAIN LINK FENCE
- UTILITY POLE
- LIGHT
- UNDERGROUND PIPELINE LOCATED BY OTHERS
- xxx EXISTING CONTOUR
- xxx.xx EXISTING ELEVATION
- OVERHEAD UTILITY LINES

**ASBUILT NOTE:**

THE POND ASBUILT EXTENDS TO THE OUTSIDE OF THE NEW LINER, AS SHOWN HEREON. AREAS OUTSIDE THE NEW LINER AND SHOWN HEREON HAVE NOT BEEN REVERIFIED

**SITE BENCHMARK 1:**  
SET CONCRETE NAIL IN WESTERLY FACE OF UTILITY POLE, WEST SIDE OF EAST ENTRANCE ROAD, 4TH UTILITY POLE SOUTH OF U.S. ROUTE 6.  
ELEVATION: 536.39 (NGVD 29)

**SITE BENCHMARK 2:**  
SET REBAR 2" S & 2.5' E OF 6' HIGH CHAIN LINK FENCE CORNER AT SOUTHEAST CORNER OF MAIN ENTRANCE ROAD & U.S. ROUTE 6.  
ELEVATION: 536.71 (NGVD 29)

**BENCHMARK:**  
WILL COUNTY CONTROL MONUMENT STATION 6274 CUT SQUARE ON CENTERLINE OF SOUTH HEADWALL IN THE SOUTHEAST CORNER OF THE INTERSECTION OF BRANDON ROAD AND MEADOW AVENUE.  
ELEVATION: 550.33 (NGVD 29)

FIELD VERIFY BENCHMARKS WITH BENCHMARK LIST.

STATE OF ILLINOIS )  
COUNTY OF WILL )

RUETTIGER, TONELLI & ASSOCIATES, INC., ILLINOIS PROFESSIONAL DESIGN FIRM No. 184-001251, HEREBY CERTIFIES THAT IT HAS TOPOGRAPHICALLY SURVEYED THE POND AREA NOTED HEREON AND AS SHOWN ON THE ANNEXED PLAT, WHICH IS A TRUE AND CORRECT REPRESENTATION OF SAID TOPOGRAPHY.

SURVEY FIELD WORK COMPLETED 10/20/08  
GIVEN UNDER MY HAND AND SEAL THIS 10th DAY OF MAY, 2008.

BY \_\_\_\_\_  
ILLINOIS PROFESSIONAL LAND SURVEYOR (MY LICENSE EXPIRES 11-30-2008)

REVISIONS			
No.	DATE	DESCRIPTION	BY
1	12/2/08	ADDED NEW ASBUILT INFORMATION	MJ

**RT Ruettiger, Tonelli & Associates, Inc.**  
Surveyors • Engineers • Planners • Landscape Architects • GIS Consultants  
 2174 ONEIDA STREET JOLIET, ILLINOIS 60435  
 2403 S. WASHINGTON STREET, SUITE 170 NAPERVILLE, ILLINOIS 60565  
 TEL (815) 744-6600 FAX (815) 744-0101 PII (630) 420-7740 FAX (630) 420-7741

DATE: 6/9/08 SCALE: 1" = 40' DRAWN BY: MJ CHECKED BY: EC  
 PREPARED FOR: BREISER CONSTRUCTION COMPANY 24101 S. MUNICIPAL DRIVE CHANNAHON, IL  
 FIELD BOOK: MIDWEST GEN PAGE: 11-13  
 DRAWING No.: 308-0363 ASBUILT WEST-ASH IMP.  
 DRAWING TITLE: ASBUILT

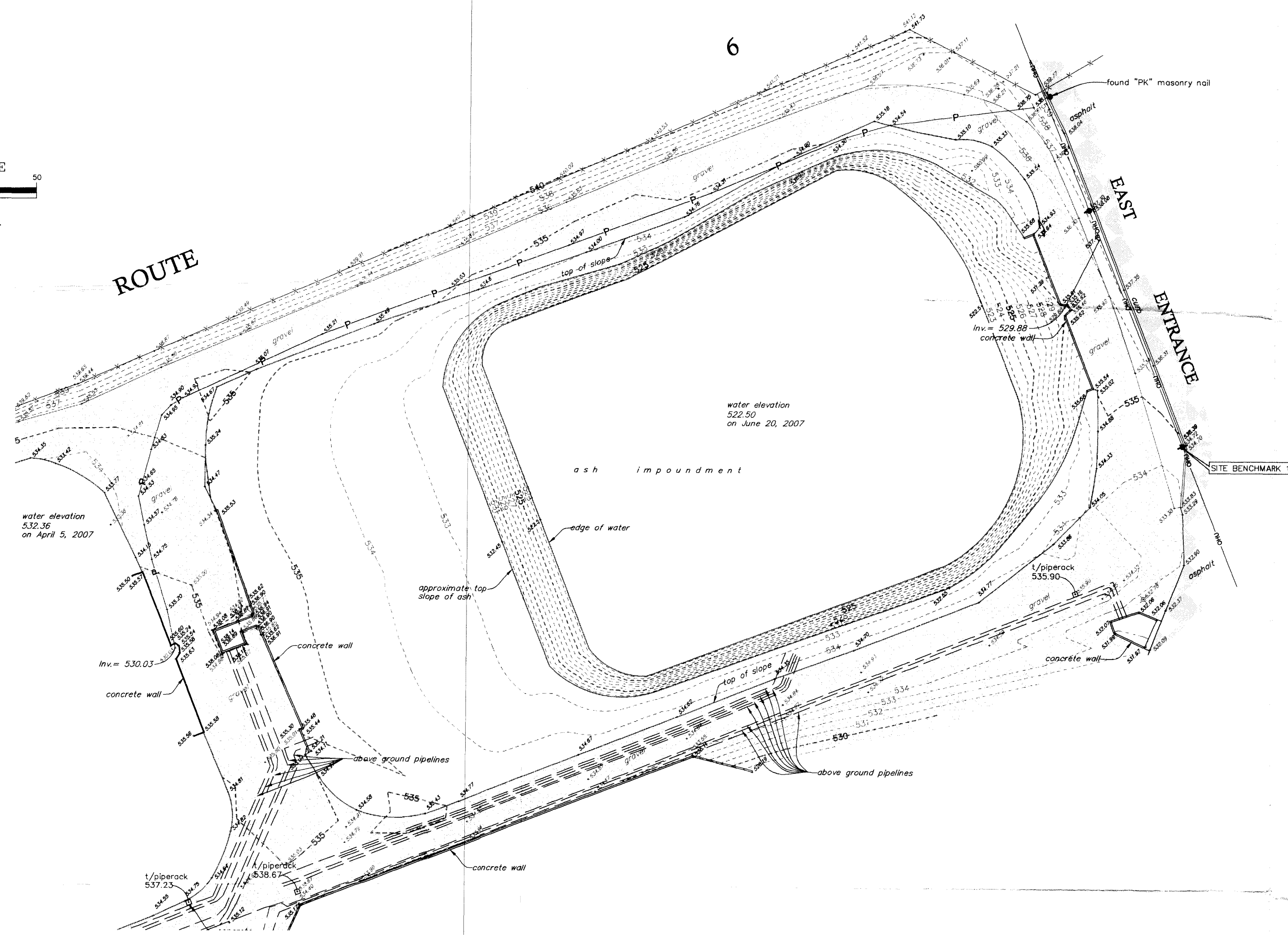
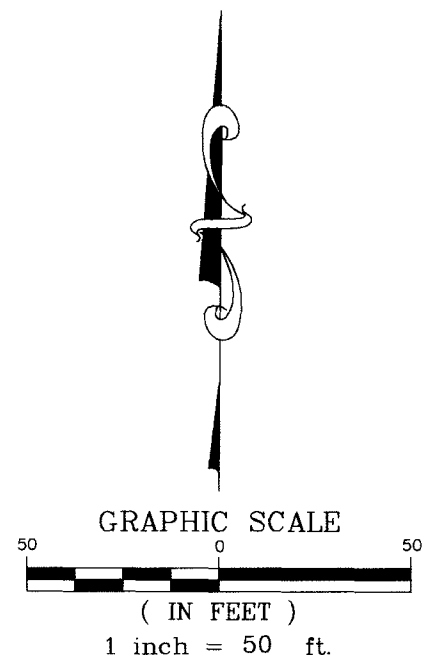

**EXISTING CONDITONS**

**LEGEND**

- mea. MEASURED
- rec. RECORDED
- calc. CALCULATED
- FOUND SURVEY MONUMENT
- SET 5/8" REBAR UNLESS OTHERWISE NOTED
- 6' HIGH CHAIN LINK FENCE
- UTILITY POLE
- ⊕ LIGHT
- P— UNDERGROUND PIPELINE LOCATED BY OTHERS
- EXISTING CONTOUR
- EXISTING ELEVATION
- OVERHEAD UTILITY LINES

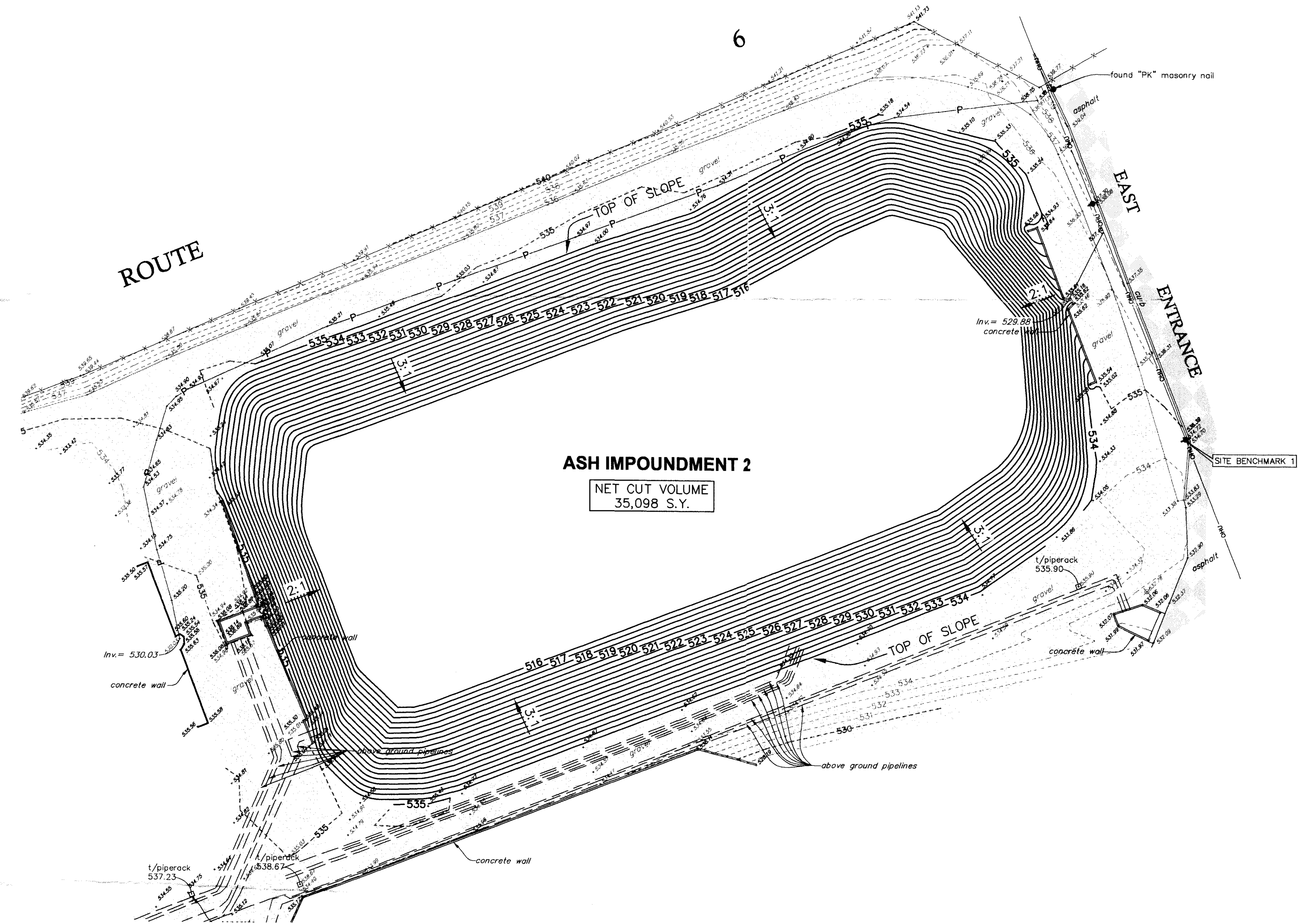

**ASH IMPOUNDMENT 2**  
NET CUT VOLUME  
35,098 S.Y.

**CONCEPTUAL DESIGN CONTOURS  
FOR PROPOSED EXCAVATION**

NOTE: THIS DESIGN IS BASED UPON INFORMATION OBTAINED IN NATURAL RESOURCE TECHNOLOGY'S DRAWING No. D1862C010-00, DATED 05-04-07.

REVISIONS			
No.	DATE	DESCRIPTION	BY

**DOCUMENTATION:**  
 PROJECT No.: 20070648  
 DATE: 06-27-07  
 FIELD BOOK: MIDWEST GEN.  
 DRAWN BY: NW  
 CHECKED BY: JPH



**Ruettiger, Tonelli & Associates, Inc.**  
 Surveyors • Engineers • Planners • Landscape Architects • G.I.S. Consultants  
 2174 ONEIDA STREET JOLIET, ILLINOIS 60435  
 2603 S. WASHINGTON STREET - SUITE 170 NAPERVILLE, ILLINOIS 60565  
 PH. (815) 744-6600 FAX (815) 744-0101 PH. (630) 420-7740 FAX (630) 420-7741

**PROJECT TITLE:**  
**MIDWEST GENERATION  
 JOLIET STATION No. 29  
 ASH IMPOUNDMENT**

**DRAWING TITLE:**  
**ASH REMOVAL EXHIBIT**

**DRAWING No.**  
307-0648-E1  
**SCALE:**  
1" = 50'  
**"DEPARTMENT"**  
SHEET 1 OF 1



# ASH IMPOUNDMENT DESIGN JOLIET STATION NO. 29 MIDWEST GENERATION JOLIET, WILL COUNTY, ILLINOIS

## LIST OF DRAWINGS

SHEET NO.	TITLE	DRAWING NO.
TS	TITLE SHEET	D1862TS-00
C010	EXISTING CONDITIONS	D1862C010-01
C020	LINER SUBGRADE PREPARATION	D1862C020-01
C030	WARNING LAYER PLAN	D1862C030-01
C031	DETAILS AND SECTIONS	D1862C031-01

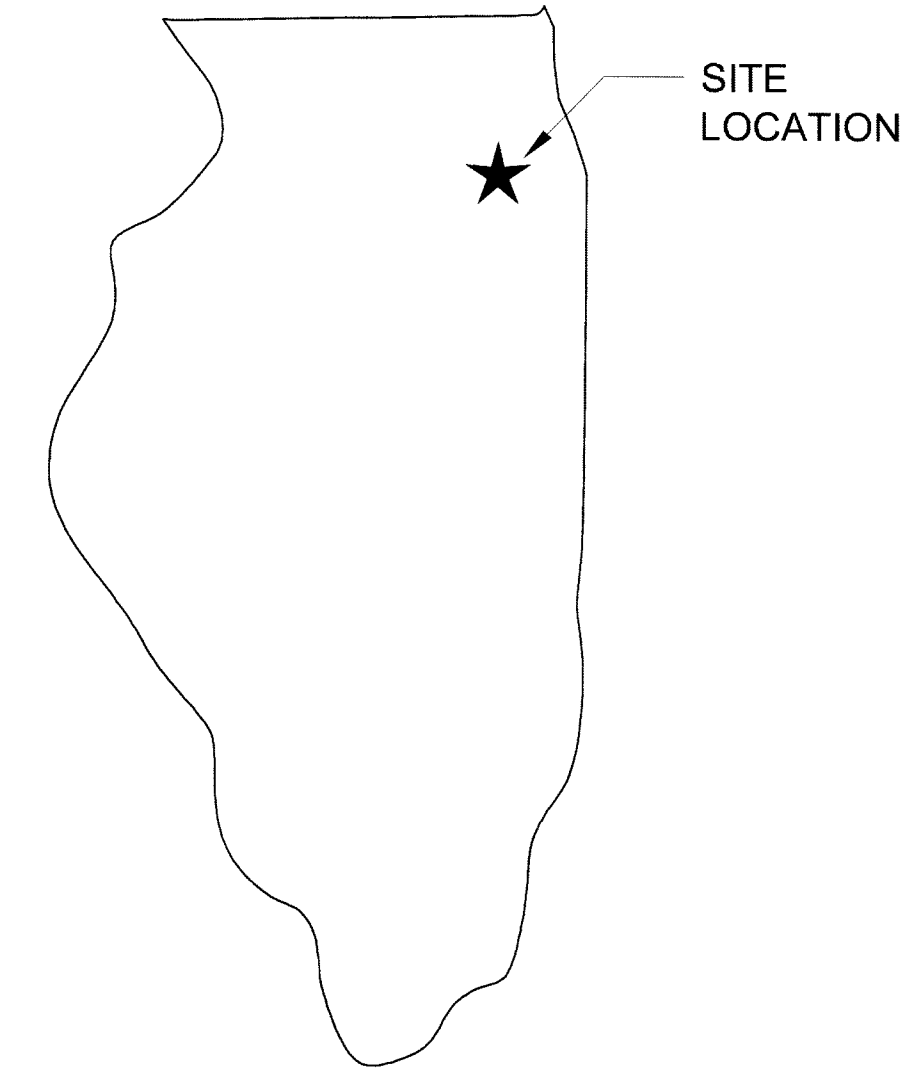

ILLINOIS

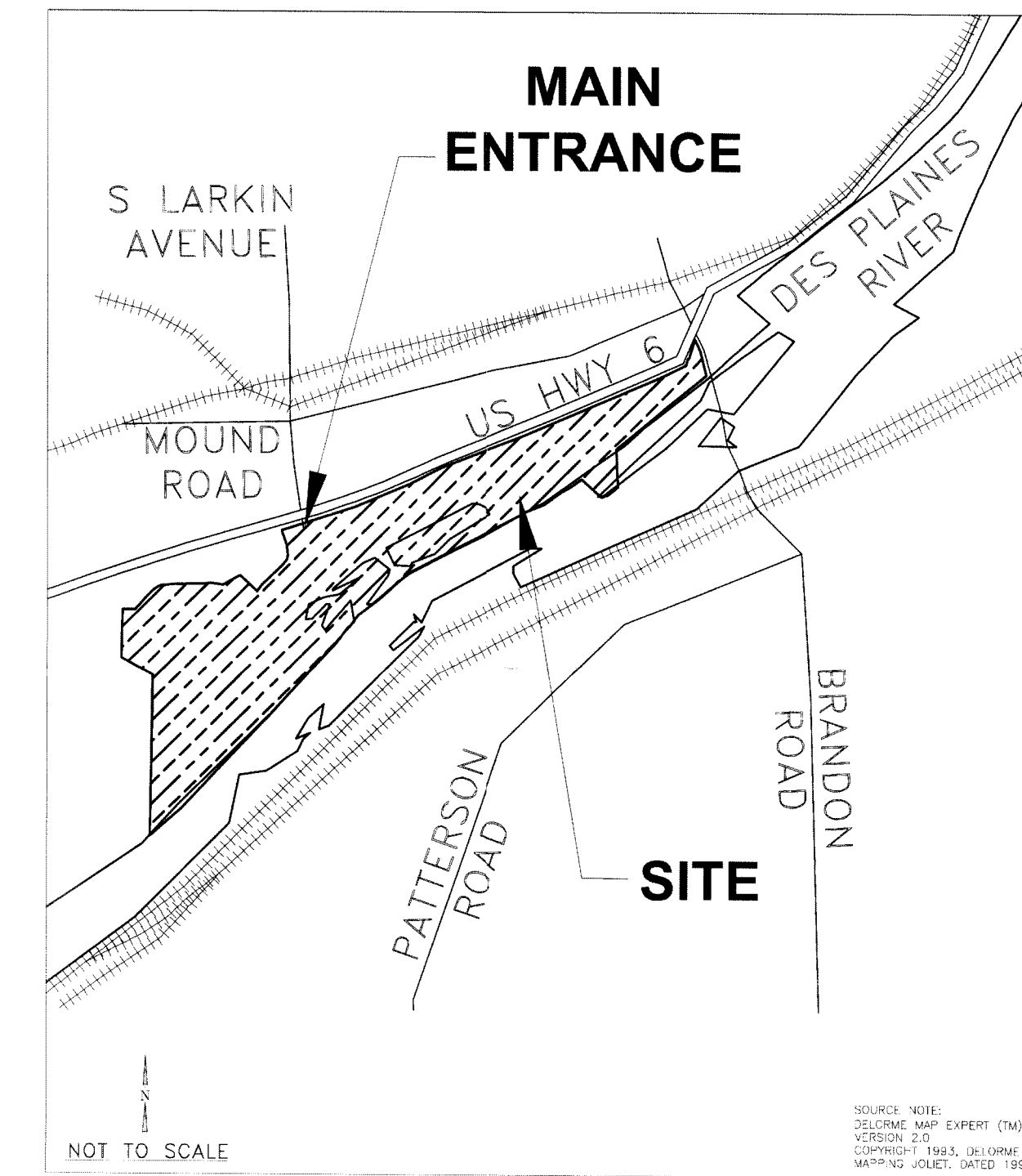

SITE VICINITY

PREPARED FOR:  
MIDWEST GENERATION, LLC  
1800 CHANNAHON ROAD  
JOLIET, ILLINOIS 60436

AUGUST 2007

NOT FOR CONSTRUCTION  
TITLE SHEET

ASH IMPOUNDMENT #2 LINER REPLACEMENT  
MIDWEST GENERATION  
JOLIET STATION NO. 29  
JOLIET, ILLINOIS

PROJECT NO.  
1862/3.0  
DRAWN BY:  
B.K. 07/12/07  
CHK'D BY:  
HMS 08/02/07  
APPROVED BY:



REVISION	DATE	APPRD. BY
6.		
5.		
4.		
3.		
2.		
1.		
0.	ISSUED FOR BID	

DRAWING NO: D1862TS-00  
REFERENCE: 1862/3/BID-CON/

SHEET NO.  
TS

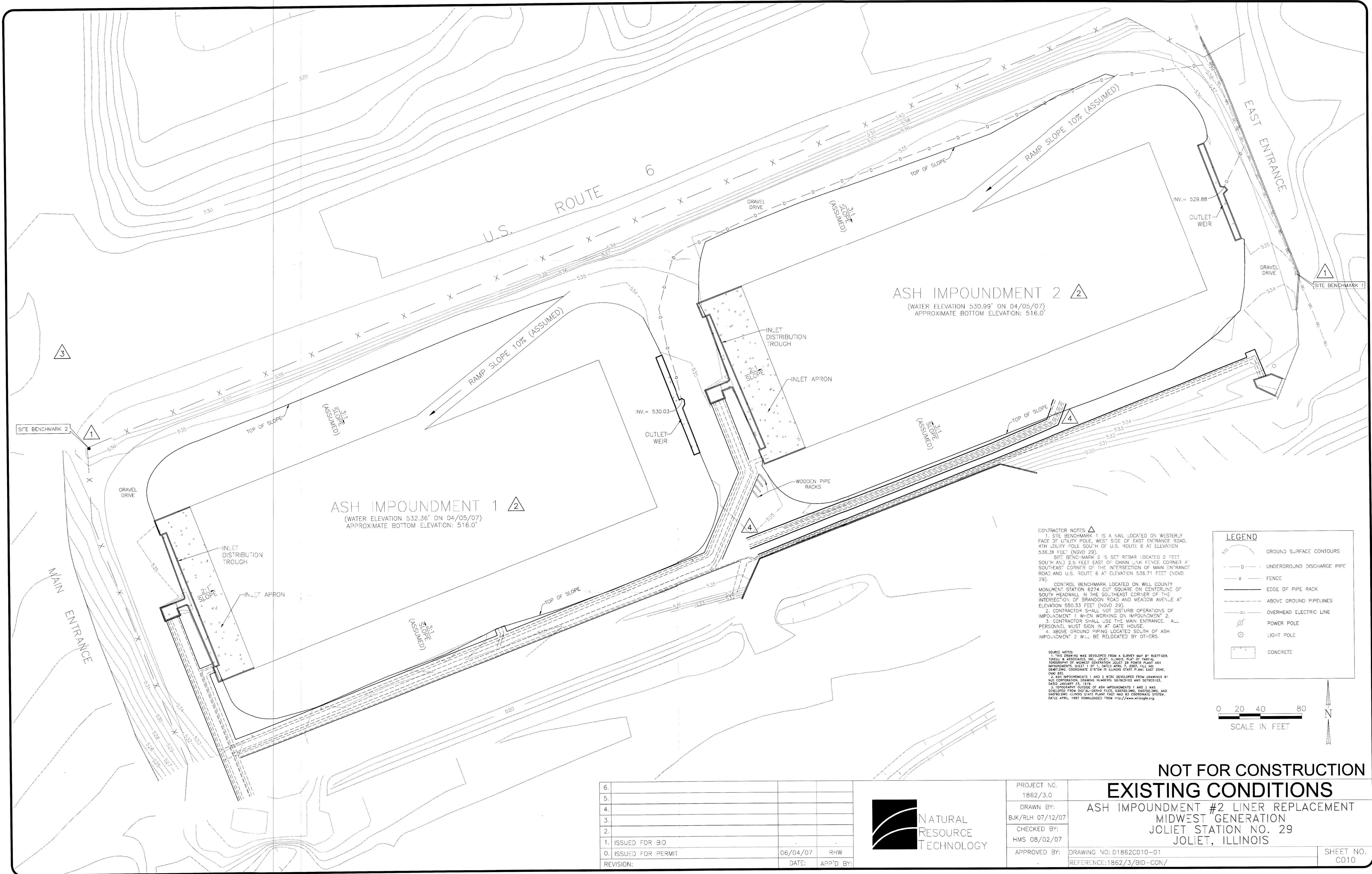

6.			
5.			
4.			
3.			
2.			
1.	ISSUED FOR BID		
0.	ISSUED FOR PERMIT	06/04/07	RHW
REVISION:		DATE:	APP'D BY:



PROJECT NO.  
1862/3.0

DRAWN BY:  
BUK/RLH 07/12/07

CHECKED BY:  
HMS 08/02/07

APPROVED BY:

**NOT FOR CONSTRUCTION**  
**EXISTING CONDITIONS**

**ASH IMPOUNDMENT #2 LINER REPLACEMENT**  
 MIDWEST GENERATION  
 JOLIET STATION NO. 29  
 JOLIET, ILLINOIS

DRAWING NO: D1862C010-01  
 REFERENCE: 1862/3/BID-CON/  
 SHEET NO. C010









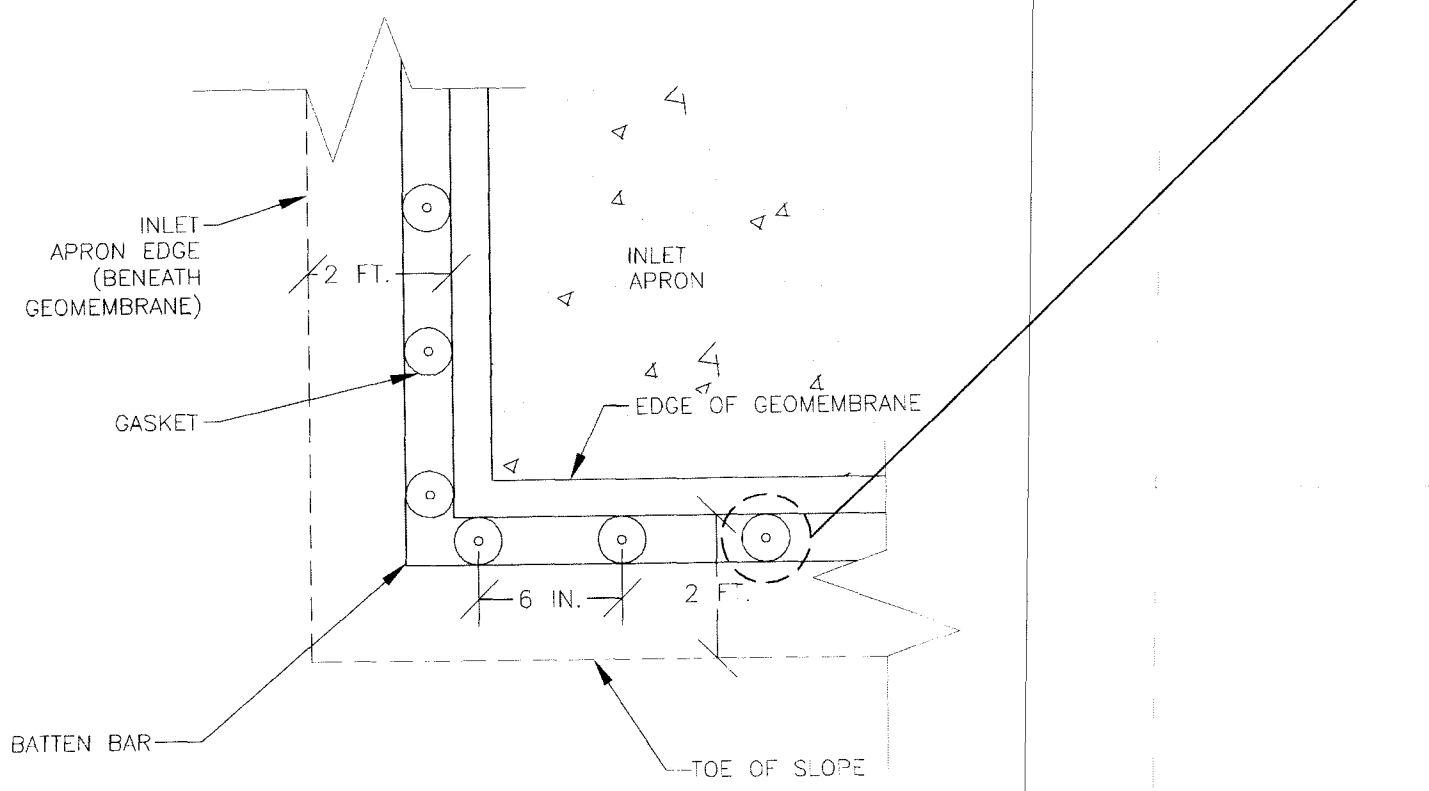
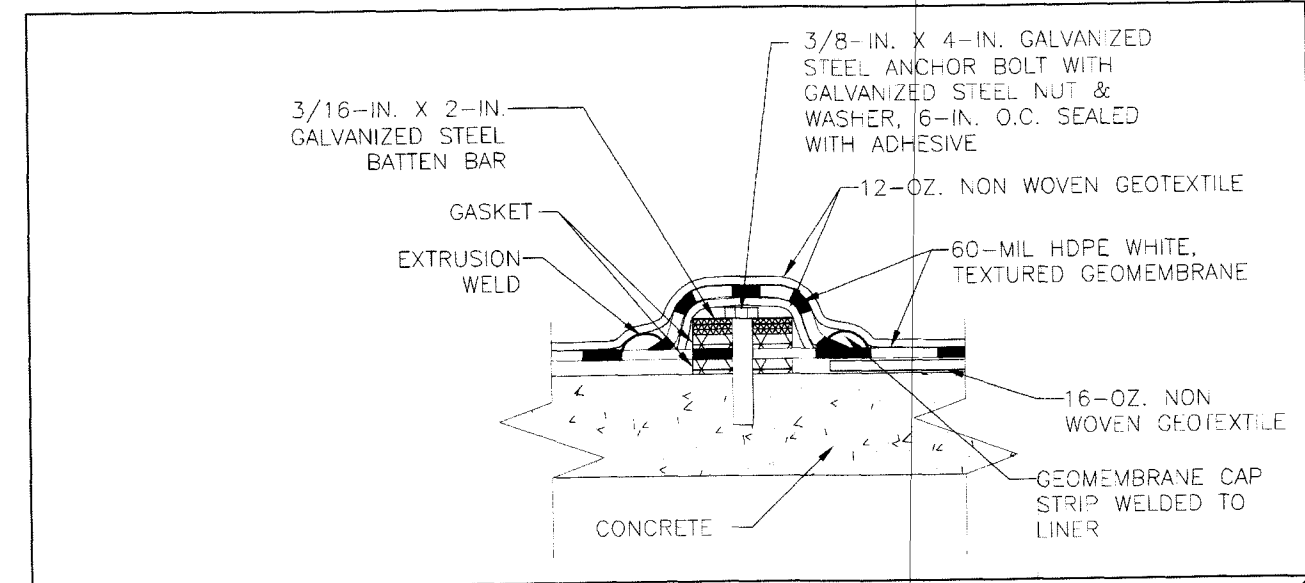

**2** INLET APRON DETAIL PLAN  
C030 NOT TO SCALE

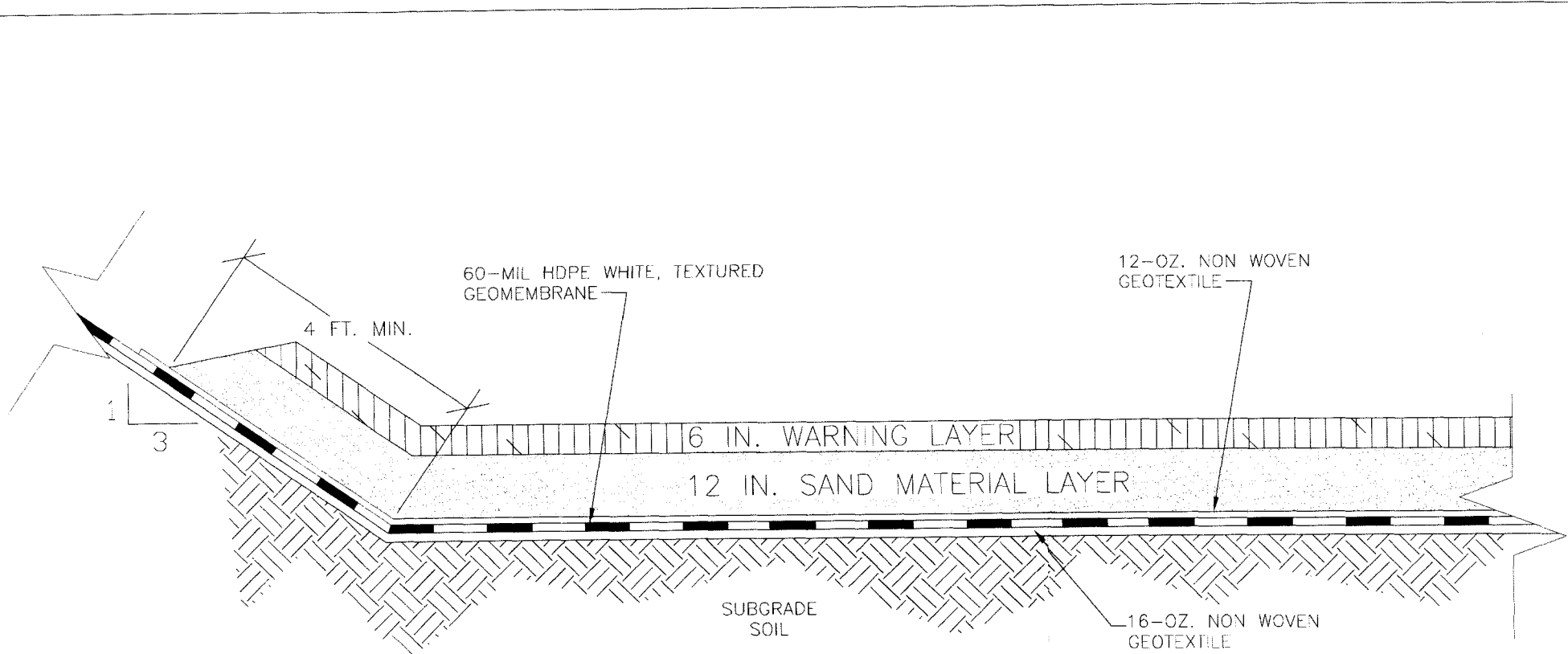

**A** SLOPE TRANSITION SECTION  
C030 NOT TO SCALE

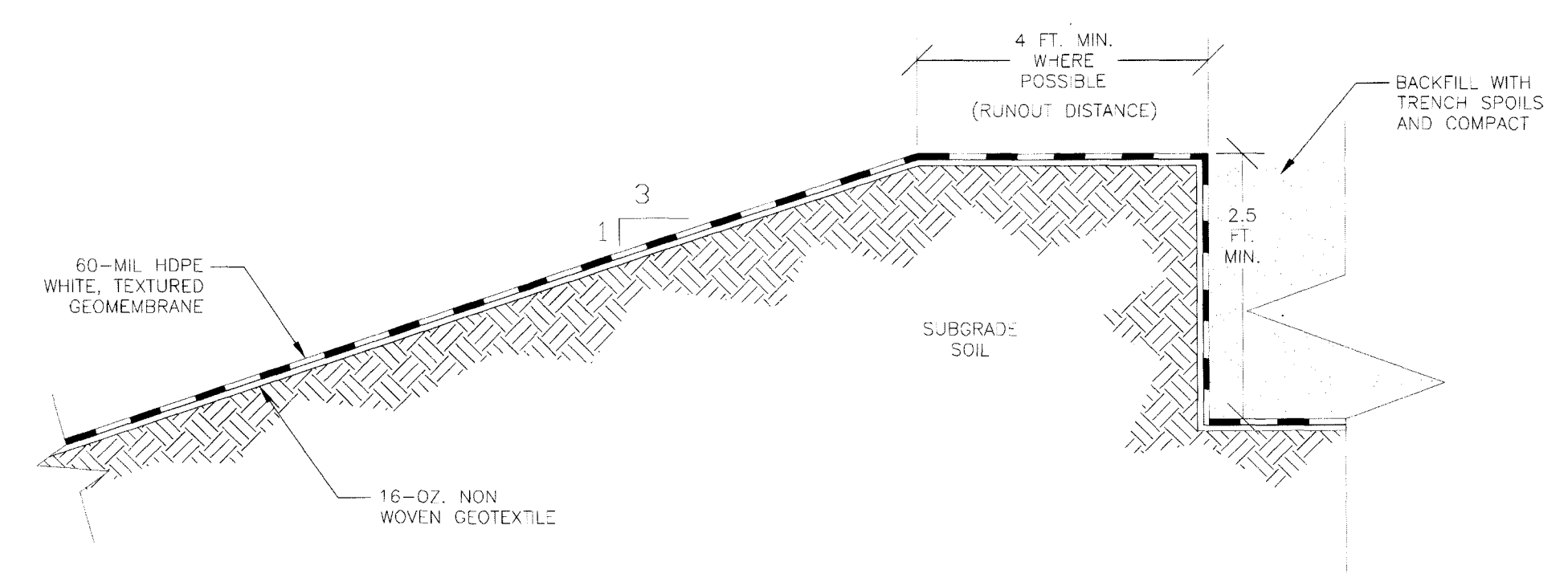

**D** ANCHOR TRENCH SECTION  
C030 NOT TO SCALE

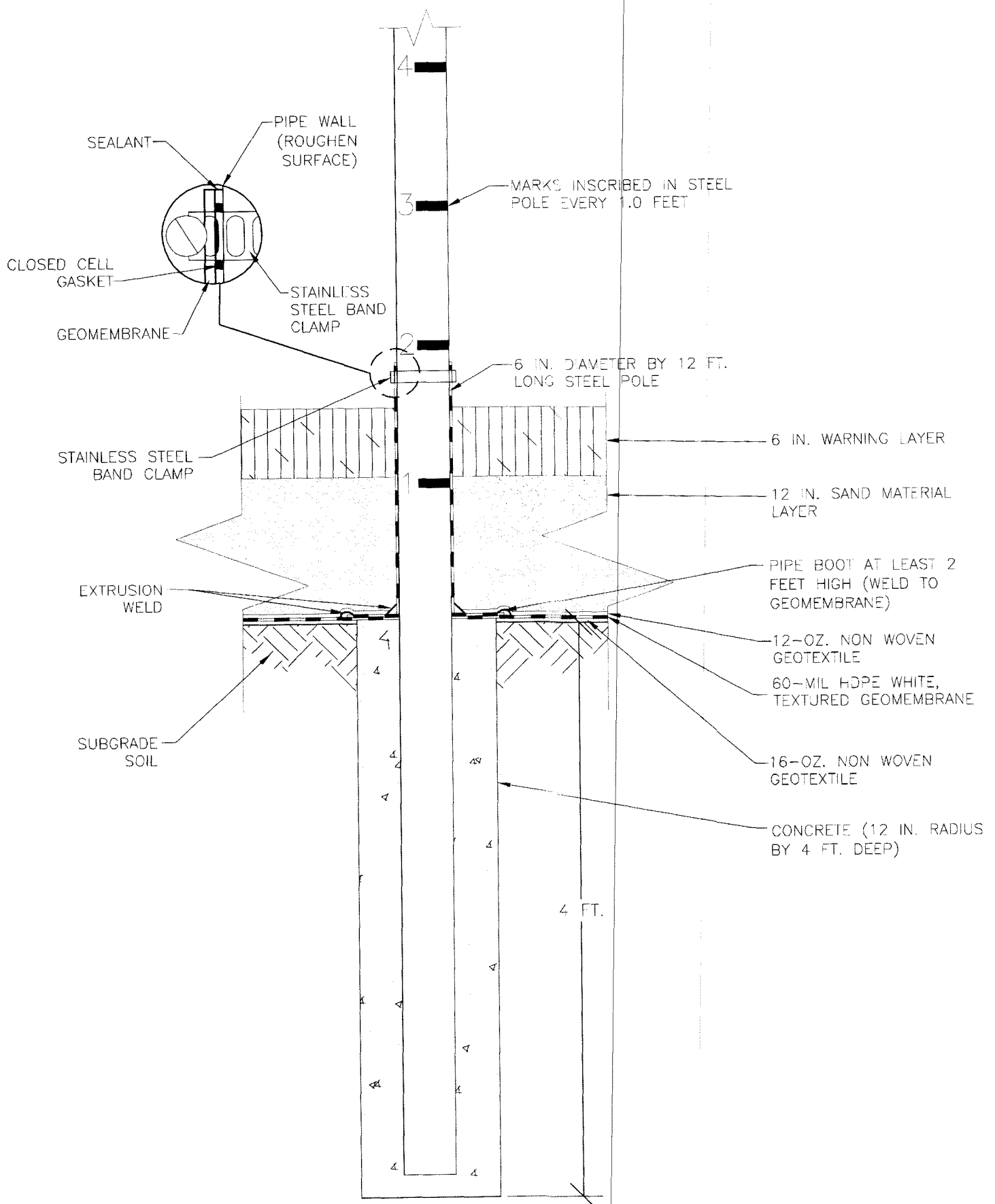

**1** MARKER POST DETAIL  
C020 NOT TO SCALE

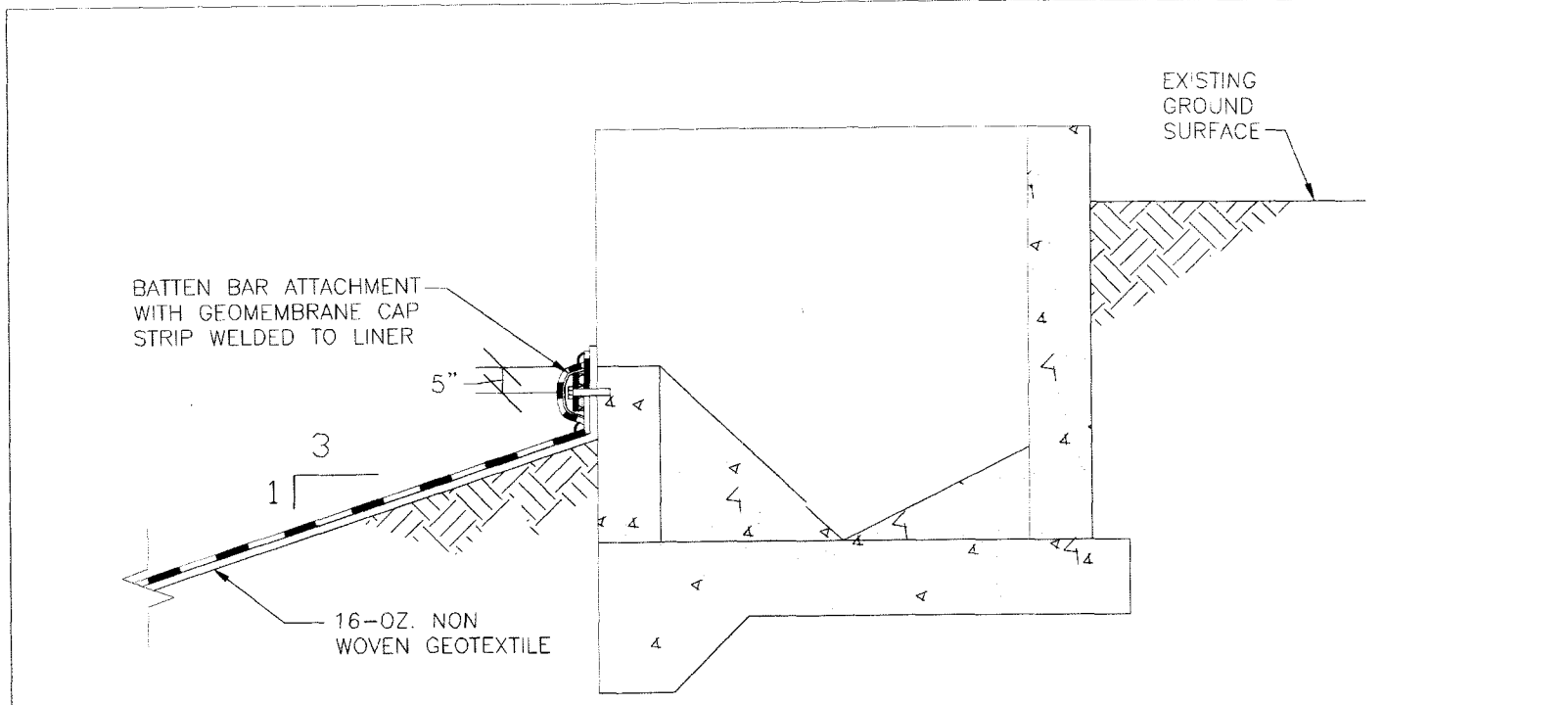

**3** OUTLET WEIR DETAIL  
C030 NOT TO SCALE

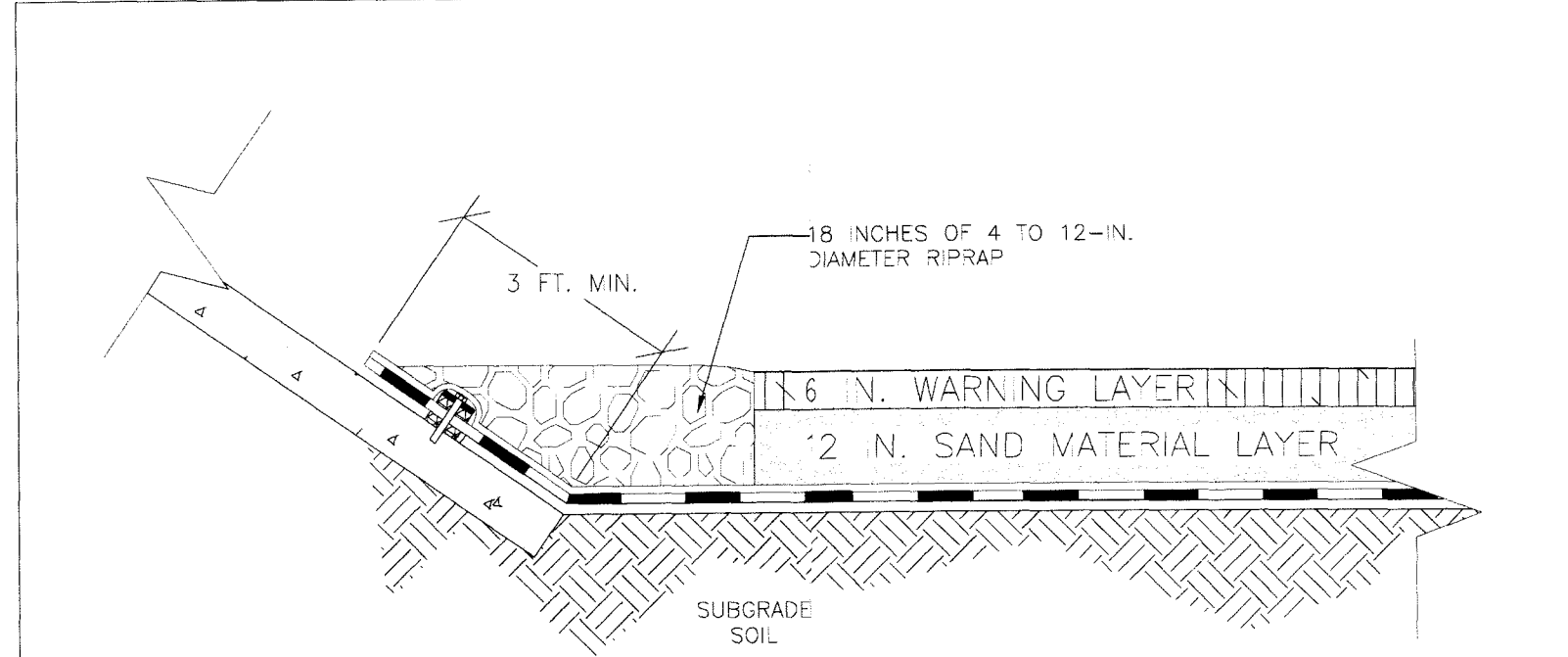

**C** INLET APRON SECTION  
NOT TO SCALE

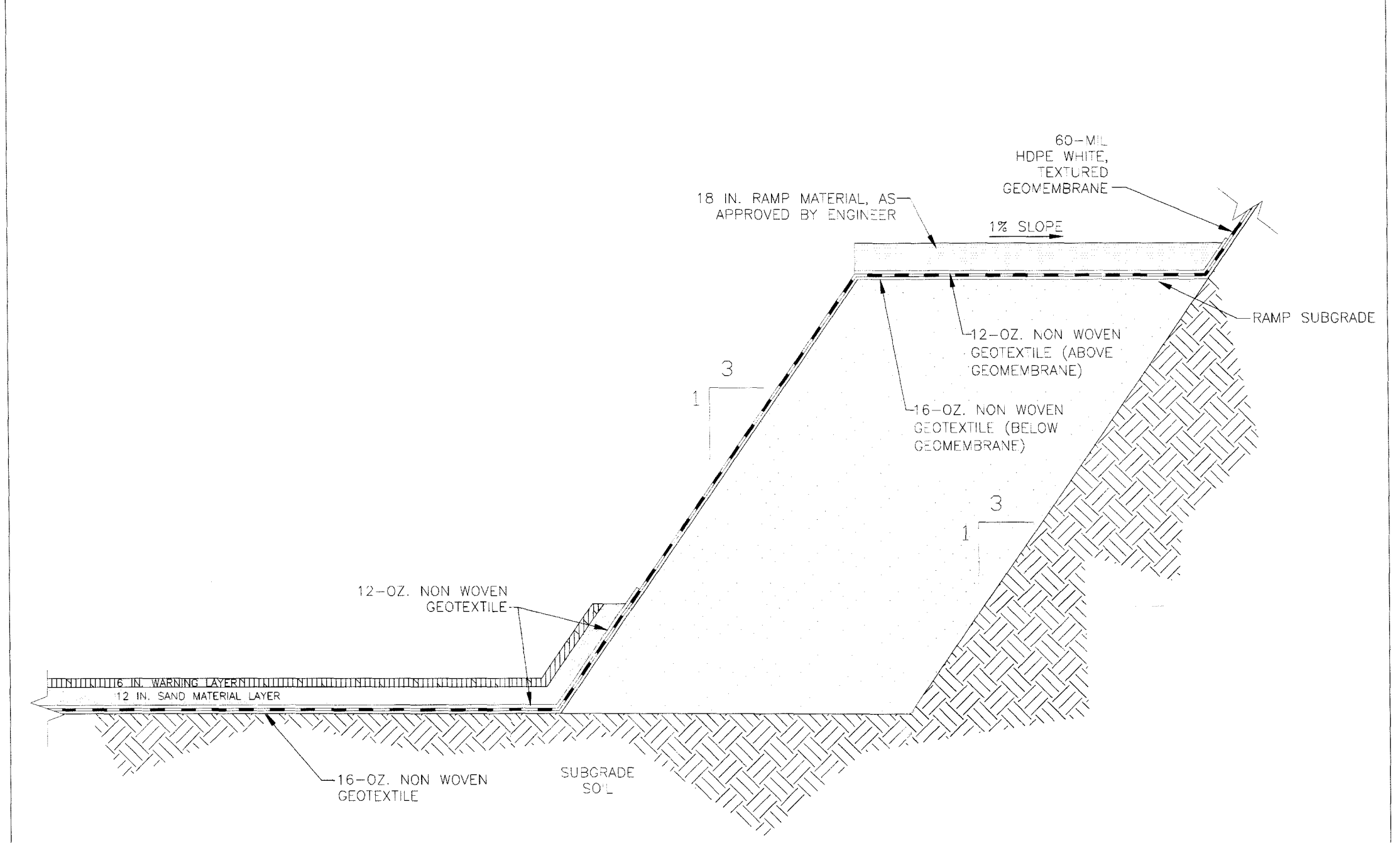

**B** RAMP SECTION  
C030 NOT TO SCALE

**NOT FOR CONSTRUCTION  
DETAILS AND SECTIONS**  
ASH IMPOUNDMENT #2 LINER REPLACEMENT  
MIDWEST GENERATION  
JOLIET STATION NO. 29  
JOLIET, ILLINOIS

6.			
5.			
4.			
3.			
2.			
1.	ISSUED FOR BID		
0.	ISSUED FOR PERMIT	06/04/07	RHW
REVISION:		DATE:	APP'D BY:



PROJECT NO.	1862/3.0
DRAWN BY:	BJK/RLH 07/12/07
CHECKED BY:	HMS 08/02/07
APPROVED BY:	
DRAWING NO.	D1862C031-01
REFERENCE:	1862/3/BID-CON/
SHEET NO.	C031

# **ATTACHMENT 7**

***Geosynthetic Institute***

475 Kedron Avenue  
Folsom, PA 19033-1208 USA  
TEL (610) 522-8440  
FAX (610) 522-8441

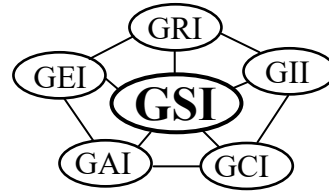

**GRI White Paper #6**

- on -

**Geomembrane Lifetime Prediction:  
Unexposed and Exposed Conditions**

by

**Robert M. Koerner, Y. Grace Hsuan and George R. Koerner  
Geosynthetic Institute  
475 Kedron Avenue  
Folsom, PA 19033 USA**

**Phone (610) 522-8440**

**Fax (610) 522-8441**

**E-mails:**

**robert.koerner@coe.drexel.edu**

**grace.hsuan@coe.drexel.edu**

**gkoerner@dca.net**

**Original: June 7, 2005**

**Updated: February 8, 2011**

**Geomembrane Lifetime Prediction: Unexposed and Exposed Conditions**

1.0 Introduction

Without any hesitation the most frequently asked question we have had over the past thirty years' is "how long will a particular geomembrane last".\* The two-part answer to the question, largely depends on whether the geomembrane is covered in a timely manner or left exposed to the site-specific environment. Before starting, however, recognize that the answer to either covered or exposed geomembrane lifetime prediction is neither easy, nor quick, to obtain. Further complicating the answer is the fact that all geomembranes are formulated materials consisting of (at the minimum), (i) the resin from which the name derives, (ii) carbon black or colorants, (iii) short-term processing stabilizers, and (iv) long-term antioxidants. If the formulation changes (particularly the additives), the predicted lifetime will also change. See Table 1 for the most common types of geomembranes and their approximate formulations.

Table 1 - Types of commonly used geomembranes and their approximate formulations (based on weight percentage)

Type	Resin	Plasticizer	Fillers	Carbon Black	Additives
HDPE	95-98	0	0	2-3	0.25-1
LLDPE	94-96	0	0	2-3	0.25-3
fPP	85-98	0	0-13	2-4	0.25-2
PVC	50-70	25-35	0-10	2-5	2-5
CSPE	40-60	0	40-50	5-10	5-15
EPDM	25-30	0	20-40	20-40	1-5

HDPE = high density polyethylene      PVC = polyvinyl chloride (plasticized)  
 LLDPE = linear low density polyethylene      CSPE = chlorsulfonated polyethylene  
 fPP = flexible polypropylene      EPDM = ethylene propylene diene terpolymer

---

\* More recently, the same question has arisen but focused on geotextiles, geogrids, geopipe, turf reinforcement mats, fibers of GCLs, etc. This White Paper, however, is focused completely on geomembranes due to the tremendous time and expense of providing such information for all types of geosynthetics.

The possible variations being obvious, one must also address the degradation mechanisms which might occur. They are as follows accompanied by some generalized commentary.

- Ultraviolet Light - This occurs only when the geosynthetic is exposed; it will be the focus of the second part of this communication.
- Oxidation - This occurs in all polymers and is the major mechanism in polyolefins (polyethylene and polypropylene) under all conditions.
- Ozone - This occurs in all polymers that are exposed to the environment. The site-specific environment is critical in this regard.
- Hydrolysis - This is the primary mechanism in polyesters and polyamides.
- Chemical - Can occur in all polymers and can vary from water (least aggressive) to organic solvents (most aggressive).
- Radioactivity - This is not a factor unless the geomembrane is exposed to radioactive materials of sufficiently high intensity to cause chain scission, e.g., high level radioactive waste materials.
- Biological - This is generally not a factor unless biologically sensitive additives (such as low molecular weight plasticizers) are included in the formulation.
- Stress State – This is a complicating factor which is site-specific and should be appropriately modeled in the incubation process but, for long-term testing, is very difficult and expensive to achieve.
- Temperature - Clearly, the higher the temperature the more rapid the degradation of all of the above mechanisms; temperature is critical to lifetime and furthermore is the key to

time-temperature-superposition which is the basis of the laboratory incubation methods which will be followed.

## 2.0 Lifetime Prediction: Unexposed Conditions

Lifetime prediction studies at GRI began at Drexel University under U. S. EPA contract from 1991 to 1997 and was continued under GSI consortium funding until ca. 2002. Focus to date has been on HDPE geomembranes placed beneath solid waste landfills due to its common use in this particular challenging application. Incubation of the coupons has been in landfill simulation cells (see Figure 1) maintained at 85, 75, 65 and 55°C. The specific conditions within these cells are oxidation beneath, chemical (water) from above, and the equivalent of 50 m of solid waste mobilizing compressive stress. Results have been forthcoming over the years insofar as three distinct lifetime stages; see Figure 2.

Stage A - Antioxidant Depletion Time

Stage B - Induction Time to the Onset of Degradation

Stage C - Time to Reach 50% Degradation (i.e., the Half-life)

### 2.1 Stage A - Antioxidant Depletion Time

The dual purposes of antioxidants are to (i) prevent polymer degradation during processing, and (ii) prevent oxidation reactions from taking place during Stage A of service life, respectively. Obviously, there can only be a given amount of antioxidants in any formulation. Once the antioxidants are depleted, additional oxygen diffusing into the geomembrane will begin to attack the polymer chains, leading to subsequent stages as shown in Figure 2. The duration of the antioxidant depletion stage depends on both the type and amount of the various antioxidants, i.e., the precise formulation.



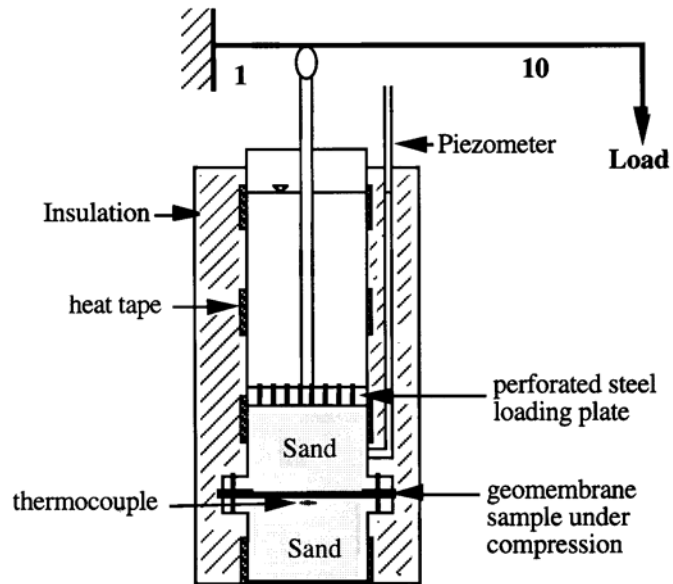

Figure 1. Incubation schematic and photograph of multiple cells maintained at various constant temperatures.

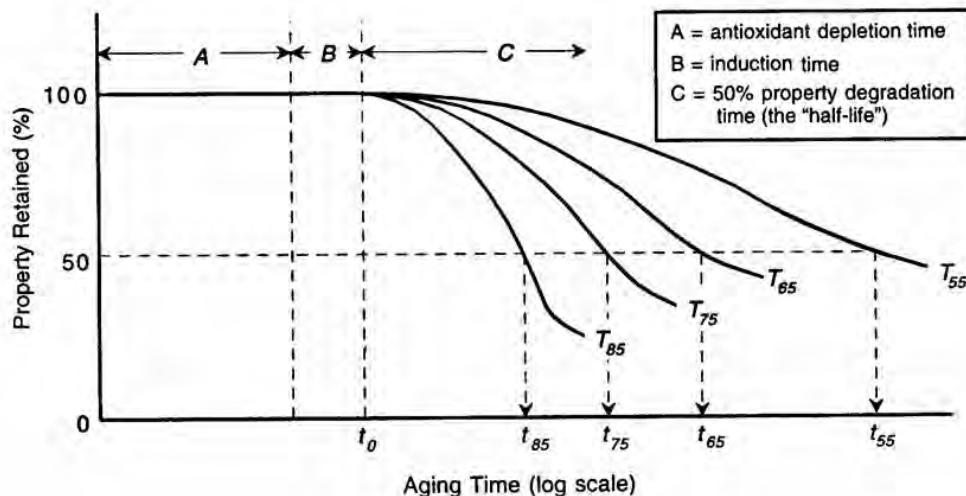

Figure 2. Three individual stages in the aging of most geomembranes.

The depletion of antioxidants is the consequence of two processes: (i) chemical reactions with the oxygen diffusing into the geomembrane, and (ii) physical loss of antioxidants from the geomembrane. The chemical process involves two main functions; the scavenging of free radicals converting them into stable molecules, and the reaction with unstable hydroperoxide (ROOH) forming a more stable substance. Regarding physical loss, the process involves the distribution of antioxidants in the geomembrane and their volatility and extractability to the site-specific environment.

Hence, the rate of depletion of antioxidants is related to the type and amount of antioxidants, the service temperature, and the nature of the site-specific environment. See Hsuan and Koerner (1998) for additional details.

## 2.2 Stage B - Induction Time to Onset of Degradation

In a pure polyolefin resin, i.e., one without carbon black and antioxidants, oxidation occurs extremely slowly at the beginning, often at an immeasurable rate. Eventually, oxidation occurs more rapidly. The reaction eventually decelerates and once again becomes very slow.

This progression is illustrated by the S-shaped curve of Figure 3(a). The initial portion of the curve (before measurable degradation takes place) is called the induction period (or induction time) of the polymer. In the induction period, the polymer reacts with oxygen forming hydroperoxide (ROOH), as indicated in Equations (1)-(3). However, the amount of ROOH in this stage is very small and the hydroperoxide does not further decompose into other free radicals which inhibits the onset of the acceleration stage.

In a stabilized polymer such as one with antioxidants, the accelerated oxidation stage takes an even longer time to be reached. The antioxidants create an additional depletion time stage prior to the onset of the induction time, as shown in Figure 3(b).

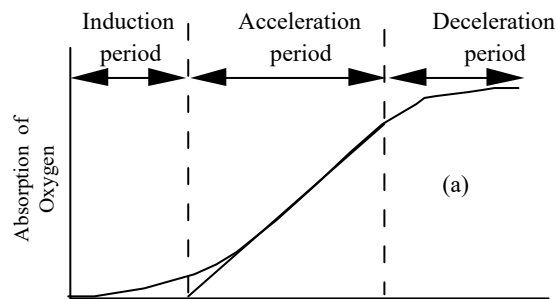

(a) Pure unstabilized polyethylene

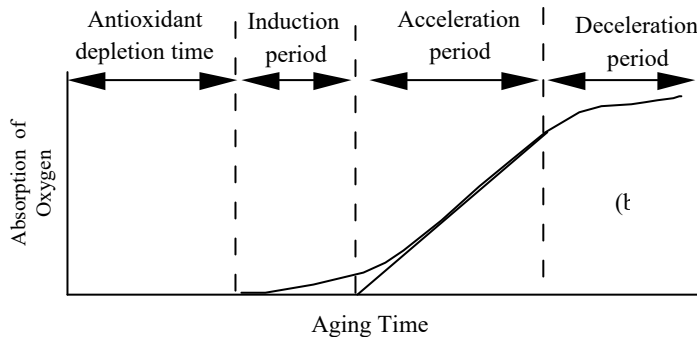

(b) Stabilized polyethylene

Figure 3. Curves illustrating various stages of oxidation.



(aided by energy or catalyst residues in the polymer)



In the above, RH represents the polyethylene polymer chains; and the symbol “•” represents free radicals, which are highly reactive molecules.

### 2.3 Stage C - Time to Reach 50% Degradation (Half-life)

As oxidation continues, additional ROOH molecules are being formed. Once the concentration of ROOH reaches a critical level, decomposition of ROOH begins, leading to a substantial increase in the amount of free radicals, as indicated in Equations (4) to (6). The additional free radicals rapidly attack other polymer chains, resulting in an accelerated chain reaction, signifying the end of the induction period, Rapoport and Zaikov (1986). This indicates that the concentration of ROOH has a critical control on the duration of the induction period.

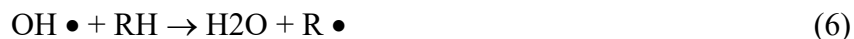
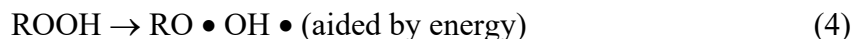

A series of oxidation reactions produces a substantial amount of free radical polymer chains (R•), called alkyl radicals, which can proceed to further reactions leading to either cross-linking or chain scission in the polymer. As the degradation of polymer continues, the physical and mechanical properties of the polymer start to change. The most noticeable change in physical properties is the melt index, since it relates to the molecular weight of the polymer. As for mechanical properties, both tensile break stress (strength) and break strain (elongation) decrease.

Ultimately, the degradation becomes so severe that all tensile properties start to change (tear, puncture, burst, etc.) and the engineering performance is jeopardized. This signifies the end of the so-called “service life” of the geomembrane.

Although quite arbitrary, the limit of service life of polymeric materials is often selected as a 50% reduction in a specific design property. This is commonly referred to as the half-life time, or simply the “half-life”. It should be noted that even at half-life, the material still exists and can function, albeit at a decreased performance level with a factor-of-safety lower than the initial design value.

#### 2.4 Summary of Lifetime Research-to-Date

Stage A, that of antioxidant depletion for HDPE geomembranes as required in the GRI-GM13 Specification, has been well established by our own research and corroborated by others, e.g., Sangram and Rowe (2004). The GRI data for standard and high pressure Oxidative Induction Time (OIT) is given in Table 2. The values are quite close to one another. Also, as expected, the lifetime is strongly dependent on the service temperature; with the higher the temperature the shorter the lifetime.

Table 2 - Lifetime prediction of HDPE (nonexposed) at various field temperatures

In Service Temperature (°C)	Stage “A” (years)			Stage “B” (years)	Stage “C” (years)	Total Prediction* (years)
	Standard OIT	High Press. OIT	Average OIT			
20	200	215	208	30	208	446
25	135	144	140	25	100	265
30	95	98	97	20	49	166
35	65	67	66	15	25	106
40	45	47	46	10	13	69

\*Total = Stage A (average) + Stage B + Stage C

Stage “B”, that of induction time, has been obtained by comparing 30-year old polyethylene water and milk containers (containing no long-term antioxidants) with currently

produced containers. The data shows that degradation is just beginning to occur as evidenced by slight changes in break strength and elongation, but not in yield strength and elongation. The lifetime for this stage is also given in Table 2.

Stage “C”, the time for 50% change of mechanical properties is given in Table 2 as well. The data depends on the activation energy, or slope of the Arrhenius curve, which is very sensitive to material and experimental techniques. The data is from Gedde, et al. (1994) which is typical of the HDPE resin used for gas pipelines and is similar to Martin and Gardner (1983).

Summarizing Stages A, B, and C, it is seen in Table 2 that the half-life of covered HDPE geomembranes (formulated according to the current GRI-GM13 Specification) is estimated to be 449-years at 20°C. This, of course, brings into question the actual temperature for a covered geomembrane such as beneath a solid waste landfill. Figure 4 presents multiple thermocouple monitoring data of a municipal waste landfill liner in Pennsylvania for over 10-years, Koerner and Koerner (2005). Note that for 6-years the temperature was approximately 20°C. At that time and for the subsequent 4-years the temperature increased to approximately 30°C. Thus, the half-life of this geomembrane is predicted to be from 166 to 446 years within this temperature range. The site is still being monitored, see Koerner and Koerner (2005).

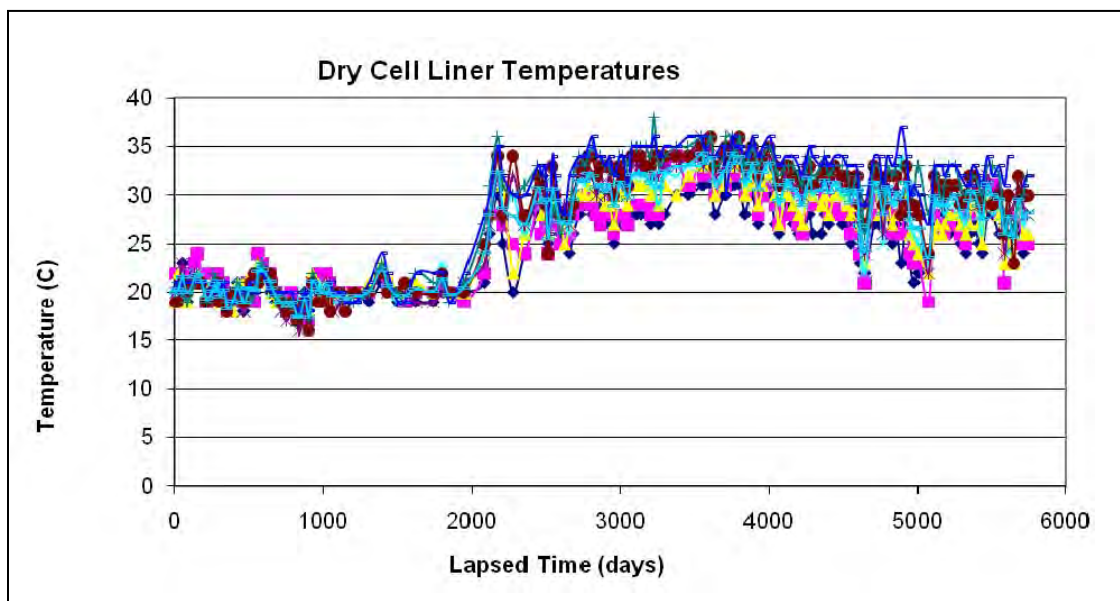

Figure 4. Long-term monitoring of an HDPE liner beneath a municipal solid waste landfill in Pennsylvania.

## 2.5 Lifetime of Other Covered Geomembranes

By virtue of its widespread use as liners for solid waste landfills, HDPE is by far the widest studied type of geomembrane. Note that in most countries (other than the U.S.), HDPE is the required geomembrane type for solid waste containment. Some commentary on other-than HDPE geomembranes (recall Table 1) follows:

### 2.5.1 Linear Low Density Polyethylene (LLDPE) geomembranes

The nature of the LLDPE resin and its formulation is very similar to HDPE. The fundamental difference is that LLDPE is a lower density, hence lower crystallinity, than HDPE; e.g., 10% versus 50%. This has the effect of allowing oxygen to diffuse into the polymer structure quicker, and likely decreases Stages A and C. How much is uncertain since no data is available, but it is felt that the lifetime of LLDPE will be somewhat reduced with respect to HDPE.

### 2.5.2 Plasticizer migration in PVC geomembranes

Since PVC geomembranes necessarily have plasticizers in their formulations so as to provide flexibility, the migration behavior must be addressed for this material. In PVC the plasticizer bonds to the resin and the strength of this bonding versus liquid-to-resin bonding is significant. One of the key parameters of a stable long-lasting plasticizer is its molecular weight. The higher the molecular weight of the plasticizer in a PVC formulation, the more durable will be the material. Conversely, low molecular weight plasticizers have resulted in field failures even under covered conditions. See Miller, et al. (1991), Hammon, et al. (1993), and Giroud and Tisinger (1994) for more detail in this regard. At present there is a considerable difference (and cost) between PVC geomembranes made in North America versus Europe. This will be apparent in the exposed study of durability in the second part of this White Paper.

### 2.5.3 Crosslinking in EPDM and CSPE geomembranes

The EPDM geomembranes mentioned in Table 1 are crosslinked thermoset materials. The oxidation degradation of EPDM takes place in either ethylene or propylene fraction of the co-polymer via free radical reactions, as expressed in Figure 5, which are described similarly by Equations (4) to (6).

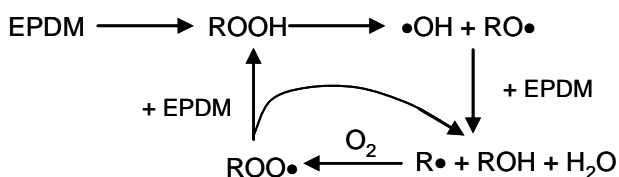

Figure 5. Oxidative degradation of crosslinked EPDM geomembranes, (Wang and Qu, 2003).

For CSPE geomembranes, the degradation mechanism is dehydrochlorination by losing chlorine and generating carbon-carbon double bonds in the main polymer chain, as shown in Figure 6.



The carbon-carbon double bonds become the preferred sites for further thermodegradation or cross-linking in the polymer, leading to eventual brittleness of the geomembrane.

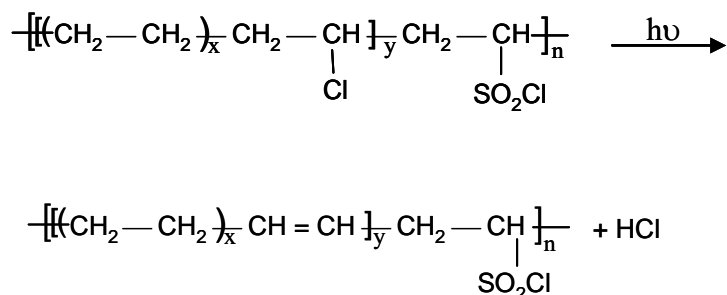

Figure 6. Dechlorination degradation of crosslinked CSPE geomembranes (Chailan, et al., 1995).

Neither EPDM nor CSPE has had a focused laboratory study of the type described for HDPE reported in the open literature. Most of lifetime data for these geomembranes is antidotal by virtue of actual field performance. Under covered conditions, as being considered in this section, there have been no reported failures by either of these thermoset polymers to our knowledge.

### 3.0 Lifetime Prediction: Exposed Conditions

Lifetime prediction of exposed geomembranes have taken two very different pathways; (i) prediction from anecdotal feedback and field performance, and (ii) from laboratory weathering device predictions.

#### 3.1 Field Performance

There is a large body of anecdotal information available on field feedback of exposed geomembranes. It comes from two quite different sources, i.e., dams in Europe and flat roofs in the USA.

Regarding exposed geomembranes in dams in Europe, the original trials were using 2.0 mm thick polyisobutylene bonded directly to the face of the dam. There were numerous problems encountered as described by Scuero (1990). Similar experiences followed using PVC

geomembranes. In 1980, a geocomposite was first used at Lago Nero which had a 200 g/m<sup>2</sup> nonwoven geotextile bonded to the PVC geomembrane. This proved quite successful and led to the now-accepted strategy of requiring drainage behind the geomembrane. In addition to thick nonwoven geotextiles, geonets, and geonet composites have been successful. Currently over 50 concrete and masonry dams have been rehabilitated in this manner and are proving successful for over 30-years of service life. The particular type of PVC plasticized geomembranes used for these dams is proving to be quite durable. Tests by the dam owners on residual properties show only nominal changes in properties, Cazzuffi (1998). As indicated in Miller, et al. (1991) and Hammond, et al. (1993), however, different PVC materials and formulations result in very different behavior; the choice of plasticizer and the material's thickness both being of paramount importance. An excellent overview of field performance is recently available in which 250 dams which have been waterproofed by geomembranes is available from ICOLD (2010).

Regarding exposed geomembranes in flat roofs, past practice in the USA is almost all with EPDM and CSPE and, more recently, with fPP. Manufacturers of these geomembranes regularly warranty their products for 20-years and such warrants appear to be justified. EPDM and CSPE, being thermoset or elastomeric polymers, can be used in dams without the necessity of having seams by using vertical attachments spaced at 2 to 4 m centers, see Scuero and Vaschetti (1996). Conversely, fPP can be seamed by a number of thermal fusion methods. All of these geomembrane types have good conformability to rough substrates as is typical of concrete and masonry dam rehabilitation. It appears as though experiences (both positive and negative) with geomembranes in flat roofs should be transferred to all types of waterproofing in civil engineering applications.

### 3.2 Laboratory Weatherometer Predictions

For an accelerated simulation of direct ultraviolet light, high temperature, and moisture using a laboratory weatherometer one usually considers a worst-case situation which is the solar maximum condition. This condition consists of global, noon sunlight, on the summer solstice, at normal incidence. It should be recognized that the UV-A range is the target spectrum for a laboratory device to simulate the naturally occurring phenomenon, see Hsuan and Koerner (1993), and Suits and Hsuan (2001).

The Xenon Arc weathering device (ASTM D4355) was introduced in Germany in 1954. There are two important features; the type of filters and the irradiance settings. Using a quartz inner and borosilicate outer filter (quartz/boro) results in excessive low frequency wavelength degradation. The more common borosilicate inner and outer filters (boro/boro) shows a good correlation with solar maximum conditions, although there is an excess of energy below 300 nm wavelength. Irradiance settings are important adjustments in shifting the response although they do not eliminate the portion of the spectrum below 300 nm frequency. Nevertheless, the Xenon Arc device is commonly used method for exposed lifetime prediction of all types of geosynthetics.

UV Fluorescent devices (ASTM D7238) are an alternative type of accelerated laboratory test device which became available in the early 1970's. They reproduce the ultraviolet portion of the sunlight spectrum but not the full spectrum as in Xenon Arc weatherometers. Earlier FS-40 and UVB-313 lamps give reasonable short wavelength output in comparison to solar maximum. The UVA-340 lamp was introduced in 1987 and its response is seen to reproduce ultraviolet light quite well. This device (as well as other types of weatherometers) can handle elevated temperature and programmed moisture on the test specimens.

Research at the Geosynthetic Institute (GSI) has actively pursued both Xenon and UV Fluorescent devices on a wide range of geomembranes. Table 3 gives the geomembranes that were incubated and the number of hours of exposure as of 12 July 2005.

Table 5 - Details of the GSI laboratory exposed weatherometer study on various types of geomembranes

Geomembrane Type	Thickness (mm)	UV Fluorescent Exposure*	Xenon Exposure*	Comment
1. HDPE (GM13)	1.50	8000 hrs.	6600 hrs.	Basis of GRI-GM13 Spec
2. LLDPE (GM17)	1.00	8000	6600	Basis of GRI-GM-17 Spec
3. PVC (No. Amer.)	0.75	8000	6600	Low Mol. Wt. Plasticizer
4. PVC (Europe)	2.50	7500	6600	High Mol. Wt. Plasticizer
5. fPP (BuRec)	1.00	2745**	4416**	Field Failure at 26 mos.
6. fPP-R (Texas)	0.91	100	100	Field Failure at 8 years
7. fPP (No. Amer.)	1.00	7500	6600	Expected Good Performance

\*As of 12 July 2005 exposure is ongoing

\*\*Light time to reach half-life of break and elongation

### 3.3 Laboratory Weatherometer Acceleration Factors

The key to validation of any laboratory study is to correlate results to actual field performance. For the nonexposed geomembranes of Section 2 such correlations will take hundreds of years for properly formulated products. For the exposed geomembranes of Section 3, however, the lifetimes are significantly shorter and such correlations are possible. In particular, Geomembrane #5 (flexible polypropylene) of Table 3 was an admittedly poor geomembrane formulation which failed in 26 months of exposure at El Paso, Texas, USA. The reporting of this failure is available in the literature, Comer, et al. (1998). Note that for both UV Fluorescent and Xenon Arc laboratory incubation of this material, failure (half-life to 50% reduction in strength and elongation) occurred at 2745 and 4416 hours, respectively. The comparative analysis of laboratory and field for this case history allows for the obtaining of acceleration factors for the two incubation devices.

### 3.3.1 Comparison between field and UV Fluorescent weathering

The light source used in the UV fluorescent weathering device is UVA with wavelengths from 295-400 nm. In addition, the intensity of the radiation is controlled by the Solar Eye irradiance control system. The UV energy output throughout the test is 68.25 W/m<sup>2</sup>.

The time of exposure to reach 50% elongation at break was as follows:

$$\begin{aligned} &= 2745 \text{ hr. of light} \\ &= 9,882,000 \text{ seconds} \end{aligned}$$

$$\begin{aligned} \text{Total energy in MJ/m}^2 &= 68.25 \text{ W/m}^2 \times 9,882,000 \\ &= 674.4 \text{ MJ/m}^2 \end{aligned}$$

The field site was located at El Paso, Texas. The UVA radiation energy (295-400 nm) at this site is estimated based on data collected by the South Florida Testing Lab in Arizona (which is a similar atmospheric location). For 26 months of exposure, the accumulated UV radiation energy is 724 MJ/m<sup>2</sup> which is very close to that generated from the UV fluorescent weatherometer. Therefore, direct comparison of the exposure time between field and UV fluorescent is acceptable.

Field time	vs.	Fluorescent UV light time:	<b>Thus, the acceleration factor is 6.8.</b>
= 26 Months		= 3.8 Months	

### 3.3.2 Comparison between field and Xenon Arc weathering

The light source of the Xenon Arc weathering device simulates almost the entire sunlight spectrum from 250 to 800 nm. Depending of the age of the light source and filter, the solar energy ranges from 340.2 to 695.4 W/m<sup>2</sup>, with the average value being 517.8 W/m<sup>2</sup>.

The time of exposure to reach 50% elongation at break

$$\begin{aligned} &= 4416 \text{ hr. of light} \\ &= 15,897,600 \text{ seconds} \end{aligned}$$

$$\begin{aligned} \text{Total energy in MJ/m}^2 &= 517.8 \text{ W/m}^2 \times 15,897,600 \\ &= 8232 \text{ MJ/m}^2 \end{aligned}$$

The solar energy in the field is again estimated based on data collected by the South Florida Testing Lab in Arizona. For 26 months of exposure, the accumulated solar energy (295-800 nm) is 15,800 MJ/m<sup>2</sup>, which is much higher than that from the UV Fluorescent device. Therefore, direct comparison of halflives obtained from the field and Xenon Arc device is not anticipated to be very accurate. However, for illustration purposes the acceleration factor based on Xenon Arc device would be as follows:

Field vs. Xenon Arc : **Thus, the acceleration factor is 4.3.**  
= 26 Months = 6.1 Months

*The resulting conclusion of this comparison of weathering devices is that the UV Fluorescent device is certainly reasonable to use for long-term incubations. When considering the low cost of the device, its low maintenance, its inexpensive bulbs, and ease of repair it (the UV Fluorescent device) will be used exclusively by GSI for long-term incubation studies.*

### 3.3.3 Update of exposed lifetime predictions

There are presently (2011) four field failures of flexible polypropylene geomembranes and using unexposed archived samples from these sites their responses in laboratory UV Fluorescent devices per ASTM D7328 at 70°C are shown in Figure 5. From this information we deduce that the average correlation factor is approximately *1200 light hours*  $\simeq$  *one-year in a hot climate*. This value will be used accordingly for other geomembranes.

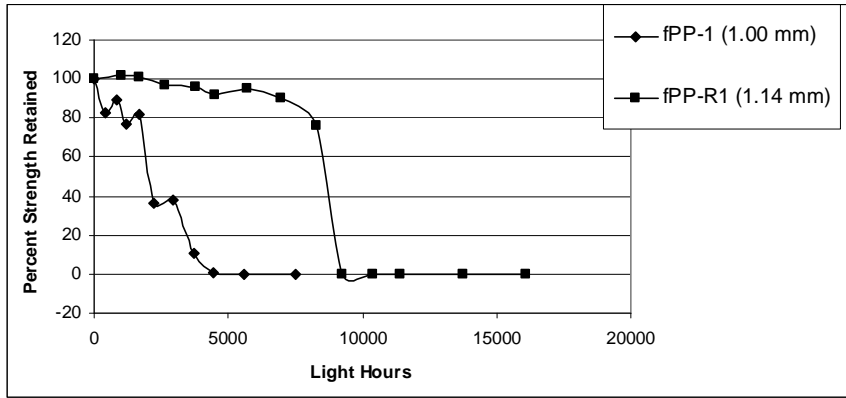

(a) Two Sites in West Texas

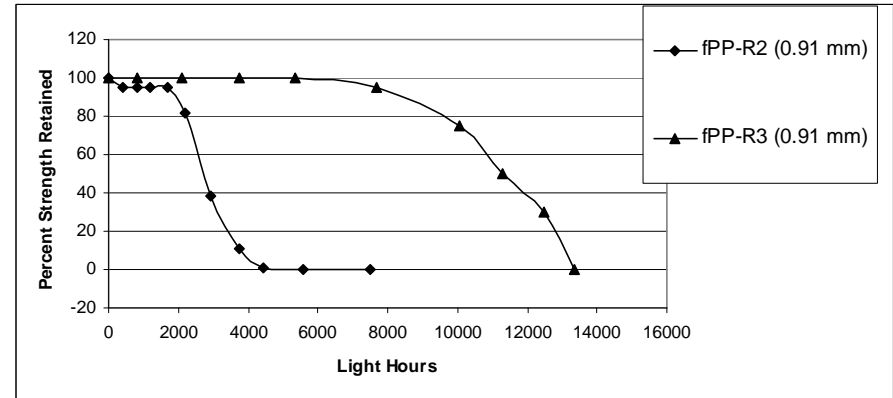

(b) Two Sites in So. Calif.

Lab-to-Field Correlation Factors  
(ASTM D7238 @ 70°C)

Method	Thickness (mm)	Field (yrs.)	Location	Lab (lt. hr.)	Factor (lt. hrs./1.0 yr.)
fPP-1	1.00	≈ 2	W. Texas	1800	900
fPP-R1	1.14	≈ 8	W. Texas	8200	1025
fPP-R2	0.91	≈ 2	So. Calif.	2500	1250
fPP-R3	0.91	≈ 8	So. Calif.	11200	1400
					1140*

\*Use 1200 lt. hr. = 1.0 year in hot climates

Figure 5. Four field failures of fPP and fPP-R exposed geomembranes.

Exposure of a number of different types of geomembranes in laboratory UV Fluorescent devices per ASTM D7238 at 70°C has been ongoing for the six years (between 2005 and 2011) since this White Paper was first released. Included are the following geomembranes:

- Two black 1.0 mm (4.0 mil) unreinforced flexible polypropylene geomembranes formulated per GRI-GM18 Specification; see Figure 6a.
- Two black unreinforced polyethylene geomembranes, one 1.5 mm (60 mil) high density per GRI-GM13 Specification and the other 1.0 mm (40 mil) linear low density per GRI-GM17 Specification; see Figure 6b.
- One 1.0 (40 mil) black ethylene polypropylene diene terpolymer geomembrane per GRI-GM21 Specification; see Figure 6c.
- Two polyvinyl chloride geomembranes, one black 1.0 mm (40 mil) formulated in North America and the other grey 1.5 mm (60 mil) formulated in Europe; see Figure 6d.

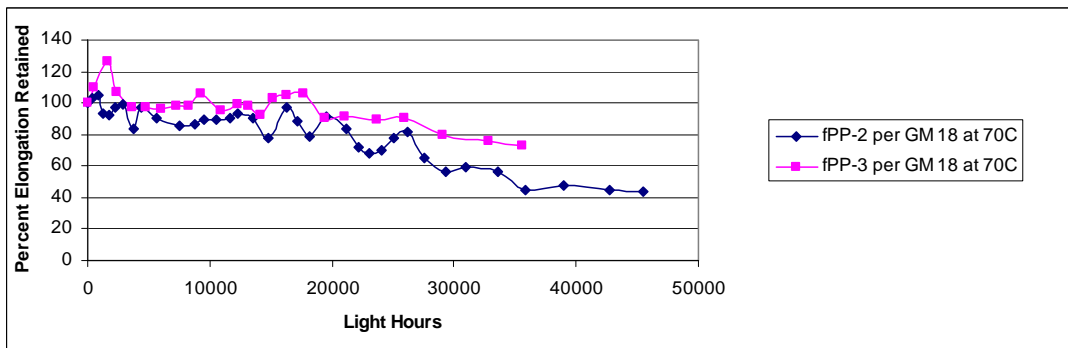
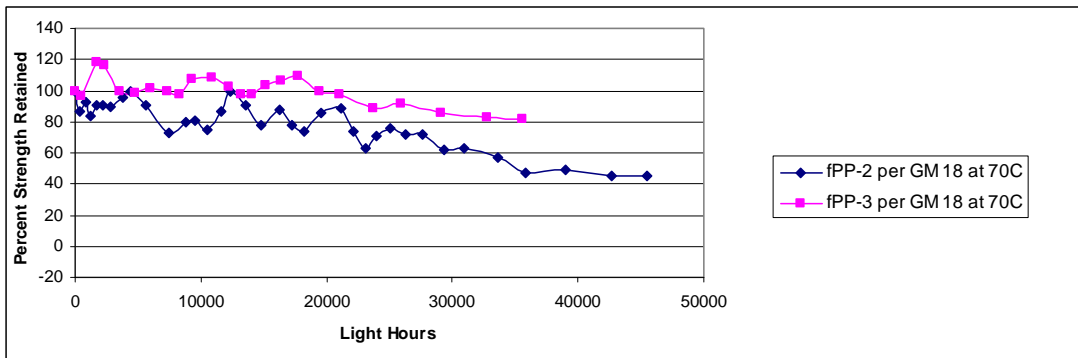

Figure 6a. Flexible polyethylene (fPP) geomembrane behavior.



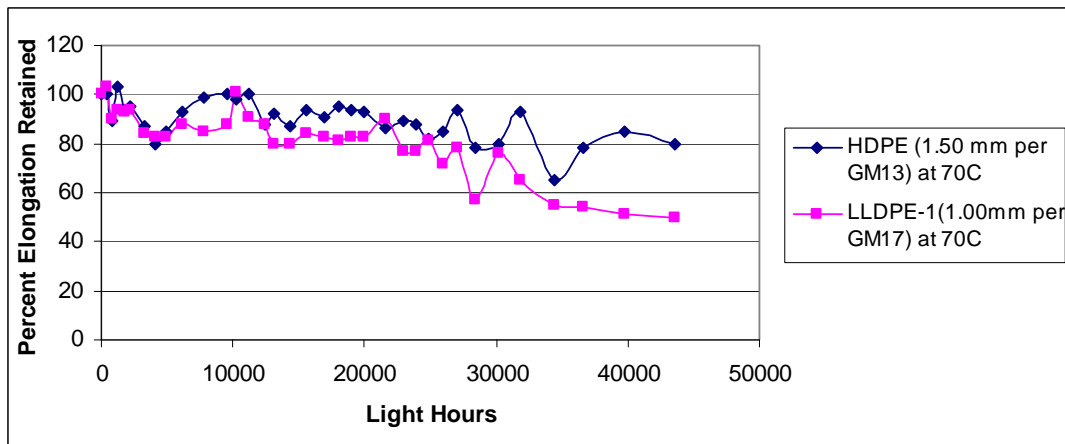
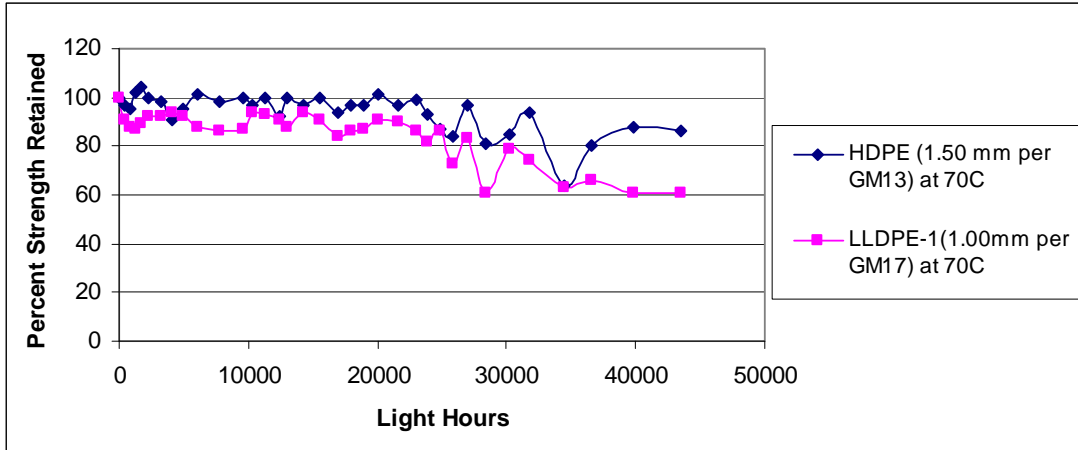

Figure 6b. Polyethylene (HDPE and LLDPE) geomembrane behavior.

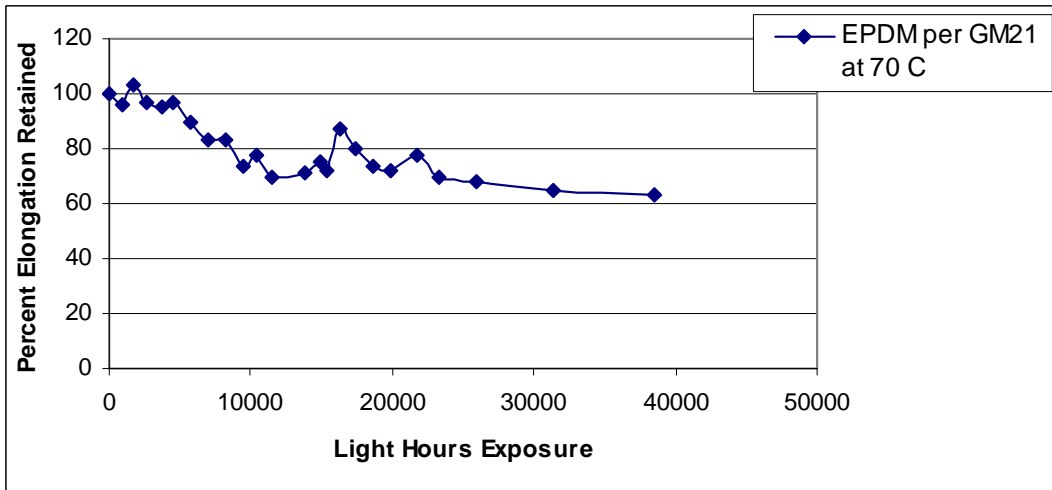
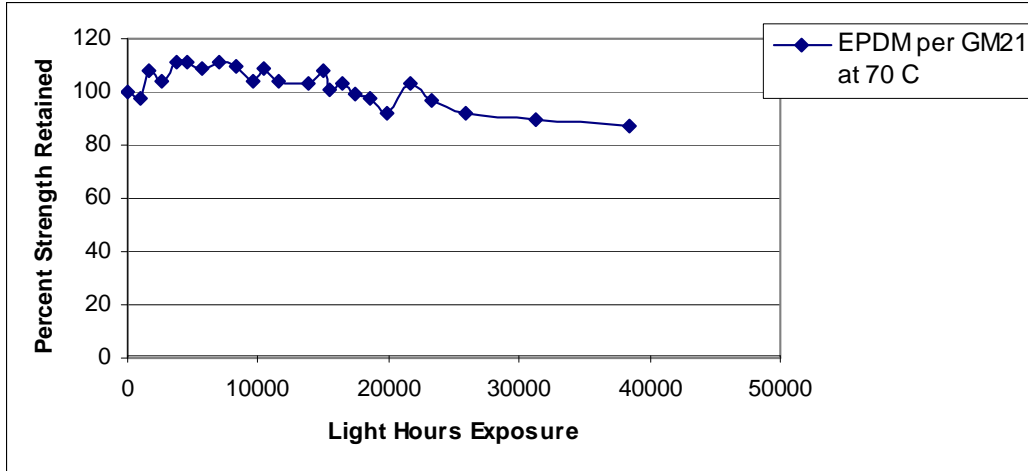

Figure 6c. Ethylene polypropylene diene terpolymer (EPDM) geomembrane.

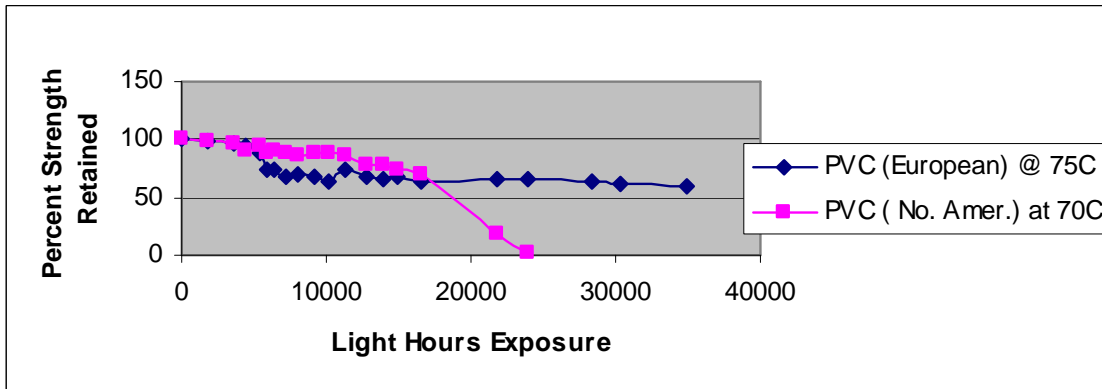

Figure 6d. Polyvinyl chloride (PVC) geomembranes.

From the response curves of the various geomembranes shown in Figure 6a-d, the 50% reduction value in strength or elongation (usually elongation) was taken as being the “halflife”. This value is customarily used by the polymer industry as being the materials lifetime prediction value. We have done likewise to develop Table 6 which is our predicted values for the designated exposed geomembrane lifetimes to date.

Table 6 – Exposed lifetime prediction results of selected geomembranes to date

Type	Specification	Prediction Lifetime in a Dry and Arid Climate
HDPE	GRI-GM13	> 36 years (ongoing)
LLDPE	GRI-GM17	≈ 36 years (halflife)
EPDM	GRI-GM21	> 27 years (ongoing)
fPP-2	GRI-GM18	≈ 30 years (halflife)
fPP-3	GRI-GM18	> 27 years (ongoing)
PVC-N.A.	(see FGI)	≈ 18 years (halflife)
PVC-Eur.	proprietary	> 32 years (ongoing)

#### 4.0 Conclusions and Recommendations

This White Paper is bifurcated into two very different parts; covered (or buried) lifetime prediction of HDPE geomembranes and exposed (to the atmosphere) lifetime prediction of a number of geomembrane types. In the covered geomembrane study we chose the geomembrane type which has had the majority of usage, that being HDPE as typically used in waste containment applications. Invariably whether used in landfill liner or cover applications *the geomembrane is covered*. After ten-years of research Table 2 (repeated here) was developed which is the conclusion of the covered geomembrane research program. Here it is seen that HDPE decreases its predicted lifetime (as measured by its halflife) from 446-years at 20°C, to 69-years at 40°C. Other geomembrane types (LLDPE, fPP, EPDM and PVC) have had

essentially no focused effort on their covered lifetime prediction of the type described herein.

That said, all are candidates for additional research in this regard.

Table 2 - Lifetime prediction of HDPE (nonexposed) at various field temperatures

In Service Temperature (°C)	Stage "A" (years)			Stage "B" (years)	Stage "C" (years)	Total Prediction* (years)
	Standard OIT	High Press. OIT	Average OIT			
20	200	215	208	30	208	446
25	135	144	140	25	100	265
30	95	98	97	20	49	166
35	65	67	66	15	25	106
40	45	47	46	10	13	69

\*Total = Stage A (average) + Stage B + Stage C

*Exposed geomembrane lifetime* was addressed from the perspective of field performance which is very unequivocal. Experience in Europe, mainly with relatively thick PVC containing high molecular weight plasticizers, has given 25-years of service and the geomembranes are still in use. Experience in the USA with exposed geomembranes on flat roofs, mainly with EPDM and CSPE, has given 20<sup>+</sup>-years of service. The newest geomembrane type in such applications is fPP which currently carries similar warranties.

Rather than using the intricate laboratory setups of Figure 1 which are necessary for covered geomembranes, exposed geomembrane lifetime can be addressed by using accelerating laboratory weathering devices. Here it was shown that the UV fluorescent device (per ASTM D7238 settings) versus the Xenon Arc device (per ASTM D 4355) is equally if not slightly more intense in its degradation capabilities. As a result, all further incubation has been using the UV fluorescent devices per D7238 at 70°C.

Archived flexible polypropylene geomembranes at four field failure sites resulted in a correlation factor of 1200 light hours equaling one-year performance in a hot climate. Using this

value on the incubation behavior of seven commonly used geomembranes has resulted in the following conclusions (recall Figure 6 and Table 6);

- HDPE geomembranes (per GRI-GM13) are predicted to have lifetimes greater than 36-years; testing is ongoing.
- LLDPE geomembranes (per GRI-GM17) are predicted to have lifetimes of approximately 36-years.
- EPDM geomembranes (per GRI-GM21) are predicted to have lifetimes of greater than 27-years; testing is ongoing.
- fPP geomembranes (per GRI-GM18) are predicted to have lifetimes of approximately 30-years.
- PVC geomembranes are very dependent on their plasticizer types and amounts, and probably thicknesses as well. The North American formulation has a lifetime of approximately 18-years, while the European formulation is still ongoing after 32-years.

Regarding continued and future recommendations with respect to lifetime prediction, GSI is currently providing the following:

- (i) Continuing the exposed lifetime incubations of HDPE, EPDM and PVC (European) geomembranes at 70°C.
- (ii) Beginning the exposed lifetime incubations of HDPE, LLDPE, fPP, EPDM and both PVC's at 60°C and 80°C incubations.
- (iii) With data from these three incubation temperatures (60, 70 and 80°C), time-temperature-superposition plots followed by Arrhenius modeling will eventually provide information such as Table 2 for covered geomembranes. This is our ultimate goal.

- (iv) Parallel lifetime studies are ongoing at GSI for four types of geogrids and three types of turf reinforcement mats at 60, 70 and 80°C.
- (v) GSI does not plan to duplicate the covered geomembrane study to other than the HDPE provided herein. In this regard, the time and expense that would be necessary is prohibitive.
- (vi) The above said, GSI is always interested in field lifetime behavior of geomembranes (and other geosynthetics as well) whether covered or exposed.

#### Acknowledgements

The financial assistance of the U. S. Environmental Protection Agency for the covered HDPE lifetime study and the member organizations of the Geosynthetic Institute and its related institutes for research, information, education, accreditation and certification is sincerely appreciated. Their identification and contact member information is available on the Institute's web site at <<geosynthetic-institute.org>>.

#### References

- Cazzuffi, D., "Long-Term Performance of Exposed Geomembranes on Dams in the Italian Alps," Proc. 6<sup>th</sup> Intl. Conf. on Geosynthetics, IFAI, 1998, pp. 1107-1114.
- Chailan, J.-F., Boiteux, C., Chauchard, J., Pinel, B. and Seytre, G., "Effect of Thermal Degradation on the Viscoelastic and Dielectric Properties of Chlorosulfonated Polyethylene (CSPE) Compounds," Journal of Polymer Degradation and Stability, Vol. 48, 1995, pp. 61-65.
- Comer, A. I., Hsuan, Y. G. and Konrath, L., "The Performance of Flexible Polypropylene Geomembranes in Covered and Exposed Environments," 6<sup>th</sup> International Conference on Geosynthetics, Atlanta, Georgia, USA, March, 1998, pp. 359-364.
- Gedde, U. W., Viebke, J., Leijstrom, H. and Ifwarson, M., "Long-Term Properties of Hot-Water Polyolefin Pipes - A Review," Polymer Engineering and Science, Vol. 34, No. 24, 1994, pp. 1773-1787.
- Giroud, J.-P. and Tisinger, L. G., "The Influence of Plasticizers on the Performance of PVC Geomembranes," PVC GRI-17 Conference, IFAI, Roseville, MN, 1994, pp. 169-196.
- Hammon, M., Hsuan, G., Levin, S. B. and Mackey, R. E., "The Re-examination of a Nine-Year-Old PVC Geomembrane Used in a Top Cap Application," 31<sup>st</sup> Annual SWANA Conference, San Jose, CA, 1993, pp. 93-108.

- Hsuan, Y. G. and Guan, Z., "Evaluation of the Oxidation Behavior of Polyethylene Geomembranes Using Oxidative Induction Time Tests," ASTM STP 1326, Riga and Patterson, Eds., ASTM, 1997, pp. 138-149.
- Hsuan, Y. G. and Koerner, R. M., "Can Outdoor Degradation be Predicted by Laboratory Acceleration Weathering?," GFR, November, 1993, pp. 12-16.
- Hsuan, Y. G. and Koerner, R. M., "Antioxidant Depletion Lifetime in High Density Polyethylene Geomembranes," Jour. Geotech. and Geoenviron. Engr., ASCE, Vol. 124, No. 6, 1998, pp. 532-541.
- ICOLD (2010), "Geomembrane Sealing Systems for Dams: Design Principles and Return of Experience," Intl. Committee on Large Dams, Bulletin 135, Paris, France.
- Koerner, G. R. and Koerner, R. M., "In-Situ Temperature Monitoring of Geomembranes," Proc. GRI-18 Conf. at GeoFrontiers, Austin, TX, 2005, 6 pgs.
- Martin, J. R. and Gardner, R. J. (1983), "Use of Plastics in Corrosion Resistant Instrumentation," 1983 Plastics Seminar, NACE, October 24-27.
- Miller, L. V., Koerner, R. M., Dewyea, J. and Mackey, R. E., "Evaluation of a 30 mil PVC Liner and Leachate Collection System," Proc. 29<sup>th</sup> Annual GRCDA/SWANA Conf., Cincinnati, OH, 1991.
- Müeller, W. and Jakob, I., "Oxidative Resistance of High-Density Polyethylene Geomembranes," Jour. Polymer Degradation and Stability," Elsevier Publ. Co., No. 79, 2003, pp. 161-172.
- Rapoport, N. Y. and Zaikov, G. E., "Kinetics and Mechanisms of the Oxidation of Stressed Polymer," Developments in Polymer Stabilization—4, G. Scott, Ed., Applied Science Publishers Ltd., London, U.K., 1986, pp. 207-258.
- Sangam, H. P. and Rowe, R. K., "Effects of Exposure Conditions on the Depletion of Antioxidants from HDPE Geomembranes", Canadian Geotechnical Journal, Vol. 39, 2002, pp. 1221-1230.
- Scuero, A., "The Use of Geocomposites for the Rehabilitation of Concrete Dams," Proc. 4<sup>th</sup> Intl. Conf. on Geosynthetics, The Hague, Balkema Publ. Co., 1990, pg. 474.
- Scuero, A. M. and Vaschetti, G. L., "Geomembranes for Masonry and Concrete Dams: State-of-the-Art Report," Proc. Geosynthetics Applications, Design and Construction, M. B. deGroot, et al., Eds., A. A. Balkema, 1996, pp. 889-898.
- Suits, L. D. and Hsuan, Y. G., "Assessing the Photo Degradation of Geosynthetics by Outdoor Exposure and Laboratory Weatherometers," Proc. GRI-15 Conference, Hot Topics in Geosynthetics II, GII Publ., Folsom, PA, 2001, pp. 267-279.
- Wang, W. and Qu, B., "Photo and Thermo-Oxidative Degradation of Photocrosslinked Ethylene-Propylene-Diene Terpolymer," Journal of Polymer Degradation and Stability, Vol. 81, 2003, pp. 531-537.

# **ATTACHMENT 8**



***Geosynthetic Institute***

475 Kedron Avenue  
Folsom, PA 19033-1208 USA  
TEL (610) 522-8440  
FAX (610) 522-8441

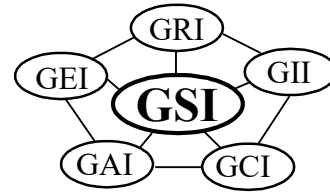

Revision 16: March 17, 2021  
Revision schedule on pg. 11

**GRI - GM13 Standard Specification\***

Standard Specification for

“Test Methods, Test Properties and Testing Frequency for  
High Density Polyethylene (HDPE) Smooth and Textured Geomembranes”<sup>SM</sup>

This specification was developed by the Geosynthetic Research Institute (GRI), with the cooperation of the member organizations for general use by the public. It is completely optional in this regard and can be superseded by other existing or new specifications on the subject matter in whole or in part. Neither GRI, the Geosynthetic Institute, nor any of its related institutes, warrant or indemnifies any materials produced according to this specification either at this time or in the future.

1. Scope

- 1.1 This specification covers high density polyethylene (HDPE) geomembranes with a formulated sheet density of 0.940 g/ml, or higher, in the thickness range of 0.75 mm (30 mils) to 3.0 mm (120 mils). Both smooth and textured geomembrane surfaces are included.
- 1.2 This specification sets forth a set of minimum, physical, mechanical and chemical properties that must be met, or exceeded by the geomembrane being manufactured. In a few cases a range is specified.
- 1.3 In the context of quality systems and management, this specification represents manufacturing quality control (MQC).

Note 1: Manufacturing quality control represents those actions taken by a manufacturer to ensure that the product represents the stated objective and properties set forth in this specification.

- 1.4 This standard specification is intended to ensure good quality and performance of HDPE geomembranes in general applications, but is possibly not adequate for the complete specification in a specific situation. Additional tests, or more restrictive

---

\*This GRI standard specification is developed by the Geosynthetic Research Institute through consultation and review by the member organizations. This specification will be reviewed at least every 2-years, or on an as-required basis. In this regard it is subject to change at any time. The most recent revision date is the effective version and it is kept current on the Institute’s Website <<geosynthetic-institute.org>>.

values for test indicated, may be necessary under conditions of a particular application.

Note 2: For information on installation techniques, users of this standard are referred to the geosynthetics literature, which is abundant on the subject.

## 2. Referenced Documents

### 2.1 ASTM Standards

- D 792 Specific Gravity (Relative Density) and Density of Plastics by Displacement
- D 1004 Test Method for Initial Tear Resistance of Plastics Film and Sheeting
- D 1238 Test Method for Flow Rates of Thermoplastics by Extrusion Plastometer
- D 1505 Test Method for Density of Plastics by the Density-Gradient Technique
- D 1603 Test Method for Carbon Black in Olefin Plastics
- D 4218 Test Method for Determination of Carbon Black Content in Polyethylene Compounds by the Muffle-Furnace Technique
- D 4833 Test Method for Index Puncture Resistance of Geotextiles, Geomembranes and Related Products
- D 5199 Test Method for Measuring Nominal Thickness of Geotextiles and Geomembranes
- D 5397 Procedure to Perform a Single Point Notched Constant Tensile Load – (SP-NCTL) Test: Appendix
- D 5596 Test Method for Microscopic Evaluation of the Dispersion of Carbon Black in Polyolefin Geosynthetics
- D 5721 Practice for Air-Oven Aging of Polyolefin Geomembranes
- D 5885 Test method for Oxidative Induction Time of Polyolefin Geosynthetics by High Pressure Differential Scanning Calorimetry
- D 5994 Test Method for Measuring the Core Thickness of Textured Geomembranes
- D 6370 Standard Test Method for Rubber-Compositional Analysis by Thermogravimetry (TGA)
- D 6693 Test Method for Determining Tensile Properties of Nonreinforced Polyethylene and Nonreinforced Flexible Polypropylene Geomembranes
- D 7238 Test Method for Effect of Exposure of Unreinforced Polyolefin Geomembrane Using Fluorescent UV Condensation Apparatus
- D 7466 Test Method for Measuring the Asperity Height of Textured Geomembranes
- D 8117 Standard Test Method for Oxidative Induction Time of Polyolefin Geosynthetics by Differential Scanning Calorimetry

### 2.2 GRI Standards

- GM10 Specification for the Stress Crack Resistance of Geomembrane Sheet

- 2.3 U. S. Environmental Protection Agency Technical Guidance Document "Quality Control Assurance and Quality Control for Waste Containment Facilities," EPA/600/R-93/182, September 1993, 305 pgs.

3. Definitions

Manufacturing Quality Control (MQC) - A planned system of inspections that is used to directly monitor and control the manufacture of a material which is factory originated. MQC is normally performed by the manufacturer of geosynthetic materials and is necessary to ensure minimum (or maximum) specified values in the manufactured product. MQC refers to measures taken by the manufacturer to determine compliance with the requirements for materials and workmanship as stated in certification documents and contract specifications.

ref. EPA/600/R-93/182

Manufacturing Quality Assurance (MQA) - A planned system of activities that provides assurance that the materials were constructed as specified in the certification documents and contract specifications. MQA includes manufacturing facility inspections, verifications, audits and evaluation of the raw materials (resins and additives) and geosynthetic products to assess the quality of the manufactured materials. MQA refers to measures taken by the MQA organization to determine if the manufacturer is in compliance with the product certification and contract specifications for the project.

ref. EPA/600/R-93/182

Formulation - The mixture of a unique combination of ingredients identified by type, properties and quantity. For HDPE polyethylene geomembranes, a formulation is defined as the exact percentages and types of resin(s), additives and carbon black.

Nominal - Representative value of a measurable property determined under a set of conditions, by which a product may be described. Abbreviated as nom. in Tables 1 and 2.

4. Material Classification and Formulation

4.1 This specification covers high density polyethylene geomembranes with a formulated sheet density of 0.940 g/ml, or higher. Density can be measured by ASTM D1505 or ASTM D792. If the latter, Method B is recommended.

4.2 The polyethylene resin from which the geomembrane is made will generally be in the density range of 0.932 g/ml or higher, and have a melt index value per ASTM D1238 of less than 1.0 g/10 min.

4.3 The resin shall be virgin material with no more than 10% rework. If rework is used, it must be a similar HDPE as the parent material.

4.4 No post consumer resin (PCR) of any type shall be added to the formulation.

5. Physical, Mechanical and Chemical Property Requirements

5.1 The geomembrane shall conform to the test property requirements prescribed in Tables 1 and 2. Table 1 is for smooth HDPE geomembranes and Table 2 is for single and double sided textured HDPE geomembranes. Each of the tables are given in English and SI (metric) units. The conversion from English to SI (metric) is soft.

Note 3: The tensile strength properties in this specification were originally based on ASTM D 638 which uses a laboratory testing temperature of  $23^{\circ}\text{C} \pm 2^{\circ}\text{C}$ . Since ASTM Committee D35 on Geosynthetics adopted ASTM D 6693 (in place of D 638), this GRI Specification followed accordingly. The difference is that D 6693 uses a testing temperature of  $21^{\circ}\text{C} \pm 2^{\circ}\text{C}$ . The numeric values of strength and elongation were not changed in this specification. If a dispute arises in this regard, the original temperature of  $23^{\circ}\text{C} \pm 2^{\circ}\text{C}$  should be utilized for testing purposes.

Note 4: There are several tests often included in other HDPE specifications which are omitted from this standard because they are outdated, irrelevant or generate information that is not necessary to evaluate on a routine MQC basis. The following tests have been purposely omitted:

- Volatile Loss
- Dimensional Stability
- Coeff. of Linear Expansion
- Resistance to Soil Burial
- Low Temperature Impact
- ESCR Test (D 1693)
- Wide Width Tensile
- Water Vapor Transmission
- Water Absorption
- Ozone Resistance
- Modulus of Elasticity
- Hydrostatic Resistance
- Tensile Impact
- Field Seam Strength
- Multi-Axial Burst
- Various Toxicity Tests

Note 5: There are several tests which are included in this standard (that are not customarily required in other HDPE specifications) because they are relevant and important in the context of current manufacturing processes. The following tests have been purposely added:

- Oxidative Induction Time
- Oven Aging
- Ultraviolet Resistance
- Asperity Height of Textured Sheet (see Note 6)

Note 6: The minimum average value of asperity height does not represent an expected value of interface shear strength. Shear strength associated with geomembranes is both site-specific and product-specific and should be determined by direct shear testing using ASTM D5321/ASTM D6243 as prescribed. This testing should be included in the particular site's CQA conformance testing protocol for the geosynthetic materials involved, or formally waived by the Design Engineer, with concurrence from the Owner prior to the deployment of the geosynthetic materials.

Note 7: There are other tests in this standard, focused on a particular property, which are updated to current standards. The following are in this category:

- Thickness of Textured Sheet
- Puncture Resistance
- Stress Crack Resistance
- Carbon Black Dispersion (In the viewing and subsequent quantitative interpretation of ASTM D 5596 only near spherical agglomerates shall be included in the assessment).

5.2 The values listed in the tables of this specification are to be interpreted according to the designated test method. In this respect they are neither minimum average roll values (MARV) nor maximum average roll values (MaxARV).

5.3 The properties of the HDPE geomembrane shall be tested at the minimum frequencies shown in Tables 1 and 2. If the specific manufacturer's quality control guide is more stringent and is certified accordingly, it must be followed in like manner.

Note 8: This specification is focused on manufacturing quality control (MQC). Conformance testing and manufacturing quality assurance (MQA) testing are at the discretion of the purchaser and/or quality assurance engineer, respectively.

## 6. Workmanship and Appearance

6.1 Smooth geomembrane shall have good appearance qualities. It shall be free from such defects that would affect the specified properties of the geomembrane.

6.2 Textured geomembrane shall generally have uniform texturing appearance. It shall be free from agglomerated texturing material and such defects that would affect the specified properties of the geomembrane.

6.3 General manufacturing procedures shall be performed in accordance with the manufacturer's internal quality control guide and/or documents.

7. MQC Sampling

7.1 Sampling shall be in accordance with the specific test methods listed in Tables 1 and 2. If no sampling protocol is stipulated in the particular test method, then test specimens shall be taken evenly spaced across the entire roll width.

7.2 The number of tests shall be in accordance with the appropriate test methods listed in Tables 1 and 2.

7.3 The average of the test results should be calculated per the particular standard cited and compared to the minimum value listed in these tables, hence the values listed are the minimum average values and are designated as "min. ave."

8. MQC Retest and Rejection

8.1 If the results of any test do not conform to the requirements of this specification, retesting to determine conformance or rejection should be done in accordance with the manufacturing protocol as set forth in the manufacturer's quality manual.

9. Packaging and Marketing

9.1 The geomembrane shall be rolled onto a substantial core or core segments and held firm by dedicated straps/slings, or other suitable means. The rolls must be adequate for safe transportation to the point of delivery, unless otherwise specified in the contract or order.

10. Certification

10.1 Upon request of the purchaser in the contract or order, a manufacturer's certification that the material was manufactured and tested in accordance with this specification, together with a report of the test results, shall be furnished at the time of shipment.

Table 1(a) – High Density Polyethylene (HDPE) Geomembrane -Smooth

Properties	Test Method	Test Value							Testing Frequency (minimum)
		30 mils	40 mils	50 mils	60 mils	80 mils	100 mils	120 mils	
Thickness (min. ave.) - mils • lowest individual of 10 values - %	D5199	nom. -10	nom. -10	nom. -10	nom. -10	nom. -10	nom. -10	nom. -10	per roll
Formulated Density (min. ave.) - g/cc	D 1505/D 792	0.940	0.940	0.940	0.940	0.940	0.940	0.940	200,000 lb
Tensile Properties (1) (min. ave.) • yield strength - lb/in. • break strength - lb/in. • yield elongation - % • break elongation - %	D 6693 Type IV	63 114 12 700	84 152 12 700	105 190 12 700	126 228 12 700	168 304 12 700	210 380 12 700	252 456 12 700	20,000 lb
Tear Resistance (min. ave.) - lb	D 1004	21	28	35	42	56	70	84	45,000 lb
Puncture Resistance (min. ave.) - lb	D 4833	54	72	90	108	144	180	216	45,000 lb
Stress Crack Resistance (2) - hr.	D5397 (App.)	500	500	500	500	500	500	500	per GRI-GM10
Carbon Black Content (range) - %	D 4218 (3)	2.0-3.0	2.0-3.0	2.0-3.0	2.0-3.0	2.0-3.0	2.0-3.0	2.0-3.0	20,000 lb
Carbon Black Dispersion	D 5596	note (4)	note (4)	note (4)	note (4)	note (4)	note (4)	note (4)	45,000 lb
Oxidative Induction Time (OIT) (min. ave.) (5) (a) Standard OIT - min. — or — (b) High Pressure OIT - min.	D 8117 D 5885	100 400	100 400	100 400	100 400	100 400	100 400	100 400	200,000 lb
Oven Aging at 85°C (5), (6) (a) Standard OIT (min. ave.) - % retained after 90 days — or — (b) High Pressure OIT (min. ave.) - % retained after 90 days	D 5721 D 8117 D 5885	55 80	55 80	55 80	55 80	55 80	55 80	55 80	per each formulation
UV Resistance (7) (a) Standard OIT (min. ave.) — or — (b) High Pressure OIT (min. ave.) - % retained after 1600 hrs (9)	D 7238 D 8117 D 5885	N.R. (8) 50	N.R. (8) 50	N.R. (8) 50	N.R. (8) 50	N.R. (8) 50	N.R. (8) 50	N.R. (8) 50	per each formulation

- (1) Machine direction (MD) and cross machine direction (XMD) average values should be on the basis of 5 test specimens each direction.  
Yield elongation is calculated using a gage length of 1.3 inches  
Break elongation is calculated using a gage length of 2.0 in.
- (2) The yield stress used to calculate the applied load for the SP-NCTL test should be the manufacturer's mean value via MQC testing.
- (3) Other methods such as D 1603 (tube furnace) or D 6370 (TGA) are acceptable if an appropriate correlation to D 4218 (muffle furnace) can be established.
- (4) Carbon black dispersion (only near spherical agglomerates) for 10 different views:  
9 in Categories 1 or 2 and 1 in Category 3
- (5) The manufacturer has the option to select either one of the OIT methods listed to evaluate the antioxidant content in the geomembrane.
- (6) It is also recommended to evaluate samples at 30 and 60 days to compare with the 90 day response.
- (7) The condition of the test should be 20 hr. UV cycle at 75°C followed by 4 hr. condensation at 60°C.
- (8) Not recommended since the high temperature of the Std-OIT test produces an unrealistic result for some of the antioxidants in the UV exposed samples.
- (9) UV resistance is based on percent retained value regardless of the original HP-OIT value.

Table 1(b) – High Density Polyethylene (HDPE) Geomembrane - Smooth

Properties	Test Method	Test Value							Testing Frequency (minimum)
		0.75 mm	1.00 mm	1.25 mm	1.50 mm	2.00 mm	2.50 mm	3.00 mm	
Thickness - (min. ave.) - mm • lowest individual of 10 values - %	D5199	nom. -10	nom. -10	nom. -10	nom. -10	nom. -10	nom. -10	nom. -10	per roll
Formulated Density (min. ave.) - g/cc	D 1505/D 792	0.940	0.940	0.940	0.940	0.940	0.940	0.940	90,000 kg
Tensile Properties (1) (min. ave.) • yield strength - kN/m • break strength - kN/m • yield elongation - % • break elongation - %	D 6693 Type IV	11 20 12 700	15 27 12 700	18 33 12 700	22 40 12 700	29 53 12 700	37 67 12 700	44 80 12 700	9,000 kg
Tear Resistance (min. ave.) - N	D 1004	93	125	156	187	249	311	374	20,000 kg
Puncture Resistance (min. ave.) - N	D 4833	240	320	400	480	640	800	960	20,000 kg
Stress Crack Resistance (2) - hr.	D 5397 (App.)	500	500	500	500	500	500	500	per GRI GM-10
Carbon Black Content (range) - %	D 4218 (3)	2.0-3.0	2.0-3.0	2.0-3.0	2.0-3.0	2.0-3.0	2.0-3.0	2.0-3.0	9,000 kg
Carbon Black Dispersion	D 5596	note (4)	note (4)	note (4)	note (4)	note (4)	note (4)	note (4)	20,000 kg
Oxidative Induction Time (OIT) (min. ave.) (5) (a) Standard OIT - min. — or — (b) High Pressure OIT - min.	D 8117 D 5885	100 400	100 400	100 400	100 400	100 400	100 400	100 400	90,000 kg
Oven Aging at 85°C (5), (6) (a) Standard OIT (min. ave.) - % retained after 90 days — or — (b) High Pressure OIT (min. ave.) - % retained after 90 days	D 5721 D 8117 D 5885	55 80	55 80	55 80	55 80	55 80	55 80	55 80	per each formulation
UV Resistance (7) (a) Standard OIT (min. ave.) — or — (b) High Pressure OIT (min. ave.) - % retained after 1600 hrs (9)	D 7238 D 8117 D 5885	N. R. (8) 50	N.R. (8) 50	N.R. (8) 50	N.R. (8) 50	N.R. (8) 50	N.R. (8) 50	N.R. (8) 50	per each formulation

- (1) Machine direction (MD) and cross machine direction (XMD) average values should be on the basis of 5 test specimens each direction  
Yield elongation is calculated using a gage length of 33 mm  
Break elongation is calculated using a gage length of 50 mm
- (2) The yield stress used to calculate the applied load for the SP-NCTL test should be the manufacturer's mean value via MQC testing.
- (3) Other methods such as D 1603 (tube furnace) or D 6370 (TGA) are acceptable if an appropriate correlation to D 4218 (muffle furnace) can be established.
- (4) Carbon black dispersion (only near spherical agglomerates) for 10 different views:  
9 in Categories 1 or 2 and 1 in Category 3
- (5) The manufacturer has the option to select either one of the OIT methods listed to evaluate the antioxidant content in the geomembrane.
- (6) It is also recommended to evaluate samples at 30 and 60 days to compare with the 90 day response.
- (7) The condition of the test should be 20 hr. UV cycle at 75°C followed by 4 hr. condensation at 60°C.
- (8) Not recommended since the high temperature of the Std-OIT test produces an unrealistic result for some of the antioxidants in the UV exposed samples.
- (9) UV resistance is based on percent retained value regardless of the original HP-OIT value.



Table 2(a) – High Density Polyethylene (HDPE) Geomembrane - Textured

Properties	Test Method	Test Value							Testing Frequency (minimum)
		30 mils	40 mils	50 mils	60 mils	80 mils	100 mils	120 mils	
Thickness mils (min. ave.) - mils • lowest individual for 8 out of 10 values - % • lowest individual for any of the 10 values - %	D 5994	nom. -5% -10 -15	nom. -5% -10 -15	nom. -5% -10 -15	nom. -5% -10 -15	nom. -5% -10 -15	nom. -5% -10 -15	nom. -5% -10 -15	per roll
Asperity Height mils (min. ave.) - mils	D 7466	16	16	16	16	16	16	16	every 2 <sup>nd</sup> roll (1)
Formulated Density (min. ave.) - g/cc	D 1505/D 792	0.940	0.940	0.940	0.940	0.940	0.940	0.940	200,000 lb
Tensile Properties (min. ave.) (2) • yield strength - lb/in. • break strength - lb/in. • yield elongation - % • break elongation - %	D 6693 Type IV	63 45 12 100	84 60 12 100	105 75 12 100	126 90 12 100	168 120 12 100	210 150 12 100	252 180 12 100	20,000 lb
Tear Resistance (min. ave.) - lb	D 1004	21	28	35	42	56	70	84	45,000 lb
Puncture Resistance (min. ave.) - lb	D 4833	45	60	75	90	120	150	180	45,000 lb
Stress Crack Resistance (3) - hr.	D 5397 (App.)	500	500	500	500	500	500	500	per GRI GM10
Carbon Black Content (range) - %	D 4218 (4)	2.0-3.0	2.0-3.0	2.0-3.0	2.0-3.0	2.0-3.0	2.0-3.0	2.0-3.0	20,000 lb
Carbon Black Dispersion	D 5596	note (5)	note (5)	note (5)	note (5)	note (5)	note (5)	note (5)	45,000 lb
Oxidative Induction Time (OIT) (min. ave.) (6) (a) Standard OIT - min. — or — (b) High Pressure OIT - min.	D 8117 D 5885	100 400	100 400	100 400	100 400	100 400	100 400	100 400	200,000 lb
Oven Aging at 85°C (6), (7) (a) Standard OIT (min. ave.) - % retained after 90 days — or — (b) High Pressure OIT (min. ave.) - % retained after 90 days	D 5721 D 8117 D 5885	55 80	55 80	55 80	55 80	55 80	55 80	55 80	per each formulation
UV Resistance (8) (a) Standard OIT (min. ave.) — or — (b) High Pressure OIT (min. ave.) - % retained after 1600 hrs (10)	D 7238 D 8117 D 5885	N.R. (9) 50	N.R. (9) 50	N.R. (9) 50	N.R. (9) 50	N.R. (9) 50	N.R. (9) 50	N.R. (9) 50	per each formulation

(1) Alternate the measurement side for double sided textured sheet

(2) Machine direction (MD) and cross machine direction (XMD) average values should be on the basis of 5 test specimens each direction.

Yield elongation is calculated using a gage length of 1.3 inches

Break elongation is calculated using a gage length of 2.0 inches

(3) SP-NCTL per ASTM D5397 Appendix, is not appropriate for testing geomembranes with textured or irregular rough surfaces. Test should be conducted on smooth edges of textured rolls or on smooth sheets made from the same formulation as being used for the textured sheet materials.

The yield stress used to calculate the applied load for the SP-NCTL test should be the manufacturer's mean value via MQC testing.

(4) Other methods such as D 1603 (tube furnace) or D 6370 (TGA) are acceptable if an appropriate correlation to D 4218 (muffle furnace) can be established.

(5) Carbon black dispersion (only near spherical agglomerates) for 10 different views:

9 in Categories 1 or 2 and 1 in Category 3

(6) The manufacturer has the option to select either one of the OIT methods listed to evaluate the antioxidant content in the geomembrane.

(7) It is also recommended to evaluate samples at 30 and 60 days to compare with the 90 day response.

(8) The condition of the test should be 20 hr. UV cycle at 75°C followed by 4 hr. condensation at 60°C.

(9) Not recommended since the high temperature of the Std-OIT test produces an unrealistic result for some of the antioxidants in the UV exposed samples.

(10) UV resistance is based on percent retained value regardless of the original HP-OIT value.

Table 2(b) – High Density Polyethylene (HDPE) Geomembrane - Textured

Properties	Test Method	Test Value							Testing Frequency (minimum)
		0.75 mm	1.00 mm	1.25 mm	1.50 mm	2.00 mm	2.50 mm	3.00 mm	
Thickness (min. ave.) - mm • lowest individual for 8 out of 10 values - % • lowest individual for any of the 10 values - %	D 5994	nom. -5% -10 -15	nom. -5% -10 -15	nom. -5% -10 -15	nom. -5% -10 -15	nom. -5% -10 -15	nom. -5% -10 -15	nom. -5% -10 -15	per roll
Asperity Height mils (min. ave.) - mm	D 7466	0.40	0.40	0.40	0.40	0.40	0.40	0.40	every 2 <sup>nd</sup> roll (1)
Formulated Density (min. ave.) - g/cc	D 1505/D 792	0.940	0.940	0.940	0.940	0.940	0.940	0.940	90,000 kg
Tensile Properties (min. ave.) (2) • yield strength - kN/m • break strength - kN/m • yield elongation - % • break elongation - %	D 6693 Type IV	11 8 12 100	15 10 12 100	18 13 12 100	22 16 12 100	29 21 12 100	37 26 12 100	44 32 12 100	9,000 kg
Tear Resistance (min. ave.) - N	D 1004	93	125	156	187	249	311	374	20,000 kg
Puncture Resistance (min. ave.) - N	D 4833	200	267	333	400	534	667	800	20,000 kg
Stress Crack Resistance (3) - hr.	D 5397 (App.)	500	500	500	500	500	500	500	per GRI GM10
Carbon Black Content (range) - %	D 4218 (4)	2.0-3.0	2.0-3.0	2.0-3.0	2.0-3.0	2.0-3.0	2.0-3.0	2.0-3.0	9,000 kg
Carbon Black Dispersion	D 5596	note (5)	note (5)	note (5)	note (5)	note (5)	note (5)	note (5)	20,000 kg
Oxidative Induction Time (OIT) (min. ave.) (6) (a) Standard OIT - min. — or — (b) High Pressure OIT - min.	D 8117 D 5885	100 400	100 400	100 400	100 400	100 400	100 400	100 400	90,000 kg
Oven Aging at 85°C (6), (7) (a) Standard OIT (min. ave.) - % retained after 90 days — or — (b) High Pressure OIT (min. ave.) - % retained after 90 days	D 5721 D 8117 D 5885	55 80	55 80	55 80	55 80	55 80	55 80	55 80	per each formulation
UV Resistance (8) (a) Standard OIT (min. ave.) — or — (b) High Pressure OIT (min. ave.) - % retained after 1600 hrs (10)	D 7238 D 8117 D 5885	N.R. (9) 50	N.R. (9) 50	N.R. (9) 50	N.R. (9) 50	N.R. (9) 50	N.R. (9) 50	N.R. (9) 50	per each formulation

(1) Alternate the measurement side for double sided textured sheet

(2) Machine direction (MD) and cross machine direction (XMD) average values should be on the basis of 5 test specimens each direction.

Yield elongation is calculated using a gage length of 33 mm

Break elongation is calculated using a gage length of 50 mm

(3) The SP-NCTL test is not appropriate for testing geomembranes with textured or irregular rough surfaces. Test should be conducted on smooth edges of textured rolls or on smooth sheets made from the same formulation as being used for the textured sheet materials.

The yield stress used to calculate the applied load for the SP-NCTL test should be the manufacturer's mean value via MQC testing.

(4) Other methods such as D 1603 (tube furnace) or D 6370 (TGA) are acceptable if an appropriate correlation to D 4218 (muffle furnace) can be established.

(5) Carbon black dispersion (only near spherical agglomerates) for 10 different views:

9 in Categories 1 or 2 and 1 in Category 3

(6) The manufacturer has the option to select either one of the OIT methods listed to evaluate the antioxidant content in the geomembrane.

(7) It is also recommended to evaluate samples at 30 and 60 days to compare with the 90 day response.

(8) The condition of the test should be 20 hr. UV cycle at 75°C followed by 4 hr. condensation at 60°C.

(9) Not recommended since the high temperature of the Std-OIT test produces an unrealistic result for some of the antioxidants in the UV exposed samples.

(10) UV resistance is based on percent retained value regardless of the original HP-OIT value.

**Adoption and Revision Schedule  
for  
HDPE Specification per GRI-GM13**

“Test Methods, Test Properties, Testing Frequency for  
High Density Polyethylene (HDPE) Smooth and Textured Geomembranes”

- Adopted: June 17, 1997
- Revision 1: November 20, 1998; changed CB dispersion from allowing 2 views to be in Category 3 to requiring all 10 views to be in Category 1 or 2. Also reduced UV percent retained from 60% to 50%.
- Revision 2: April 29, 1999: added to Note 5 after the listing of Carbon Black Dispersion the following: “(In the viewing and subsequent quantitative interpretation of ASTM D5596 only near spherical agglomerates shall be included in the assessment)” and to Note (4) in the property tables.
- Revision 3: June 28, 2000: added a new Section 5.2 that the numeric table values are neither MARV or MaxARV. They are to be interpreted per the the designated test method.
- Revision 4: December 13, 2000: added one Category 3 is allowed for carbon black dispersion. Also, unified terminology to “strength” and “elongation”.
- Revision 5: May 15, 2003: Increased minimum acceptable stress crack resistance time from 200 hrs to 300 hrs.
- Revision 6: June 23, 2003: Adopted ASTM D 6693, in place of ASTM D 638, for tensile strength testing. Also, added Note 2.
- Revision 7: February 20, 2006: Added Note 6 on Asperity Height clarification with respect to shear strength.
- Revision 8: Removed recommended warranty from specification.
- Revision 9: June 1, 2009: Replaced GRI-GM12 test for asperity height of textured geomembranes with ASTM D 7466.
- Revision 10: April 11, 2011: Added alternative carbon black content test methods
- Revision 11: December 13, 2012: Replaced GRI-GM11 with the equivalent ASTM D 7238.
- Revision 12: November 14, 2014: Increased minimum acceptable stress crack resistance time from 300 to 500 hours. Also, increased asperity height of textured sheet from 10 to 16 mils (0.25 to 0.40 mm).
- Revision 13: November 4, 2015: Removed Footnote (1) on asperity height from tables.
- Revision 14: January 6, 2016: Removed Trouser Tear from Note 5.
- Revision 15: September 9, 2019: Editorial update to harmonize tables.
- Revision 16: March 17, 2021: Updated Standard OIT Test from ASTM D3895 to D8117

# **ATTACHMENT 9**



# THE BENEFITS OF WHITE-FINISHED GEOMEMBRANES IN AREAS WITH HIGH UV RADIATION

BY DONIA HAMDI-AKRICHE, TECHNICAL MANAGER – EMEA

21 Mar. 2019 | [Mining, Waste Management, Water Management](#) |

Durability remains one of the biggest concerns for users of geomembranes, especially in regions around the world with high ultraviolet (UV) radiation. While several factors contribute to the overall lifetime expectancy of geomembranes, studies have shown that the addition of a white solar-reflecting finish can extend their service life.

Electronic Filing: Received, Clerk's Office 3/24/2022

Black surfaces absorb solar UV radiation, increasing the internal temperature of the geomembrane, whereas white-surfaced geomembranes contribute to maximum reflection of sunlight, thus reducing the temperature of the geomembrane.

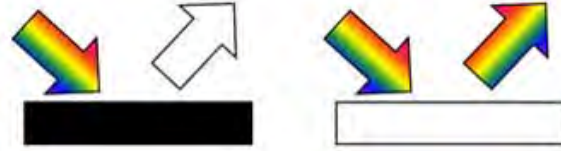

Due to their cooler temperature, white-surfaced geomembranes' contraction and expansion can be reduced by up to 40%. This leads to a reduced impact from heat degradation, which means a lowered rate of loss of antioxidants and a prolonged service life.

**Table 1: Surface comparison**

AMBIENT AIR TEMPERATURE, AAT (°C)	HDPE GMB LINER	HDPE GMB LINER TEMPERATURE, LT (°C)	Δ TEMPERATURE (°C) FROM SMOOTH BLACK HDPE GMB LINER
30	Smooth Black	67	-
	Textured Black	64	-3
	Grey / White	49	-18
	White	43	-24
18	Smooth Black	25	-
	White	17	-8

*(Data after Cadwallader, Cranston and Peggs 1993)*

### The effects of high temperature on geomembranes.

**Table 2: Lifetime prediction of high-density polyethylene geomembrane at elevated field temperatures by the Geosynthetics Research Institute**

Electronic Filing: Received, Clerk's Office 3/24/2022

IN SERVICE TEMPERATURE, (°C)	STAGE "A" (YEARS)			STAGE "B" (YEARS)	STAGE "C" (YEARS)	TOTAL PREDICTION* (YEARS)
	STANDARD OIT	HIGH PRESS. OIT	AVERAGE OIT			
20	200	215	208	30	208	446
25	135	144	140	25	100	265
30	95	98	97	20	49	166
35	65	67	66	15	25	106
40	45	47	46	10	13	69

\*Total = Stage A (average) + Stage B + Stage C

**Aging:** The higher the in-service temperature, the faster the geomembrane will reach "Stage C" of its lifetime, where it loses 50% of its properties. Thus, the lifetime durability of the geomembrane will drastically decrease.

At a given ambient temperature, a white geomembrane will not be as hot as a black geomembrane, which will reduce its aging rate and increase its lifespan.

**Expansion:** According to the equation of linear expansion or contraction considering the linear thermal expansivity of the material, the greater the difference between the ambient temperature at installation and the temperature of the geomembrane, the more the geomembrane will expand.



Expansion results in increased wrinkling, which:

- Decreases the intimate contact with the subgrade, thereby decreasing the shear strength and increasing potential leakage
- Creates flow barriers and ponding, thus reducing the effectiveness of the drainage system
- Causes stress concentrations when they fold over or collapse
- Once in place and covered, do not go away and can cause poor long-term performance.

Due to its cooler temperature, white geomembrane does not expand as much as black liner, thus causing fewer wrinkles and extending its lifespan.

## Advantages of white reflective liner in countries with high UV radiation

**Figure 1:**

**Geomembrane temperature variation at ambient temperatures from 15 to 30 °C**

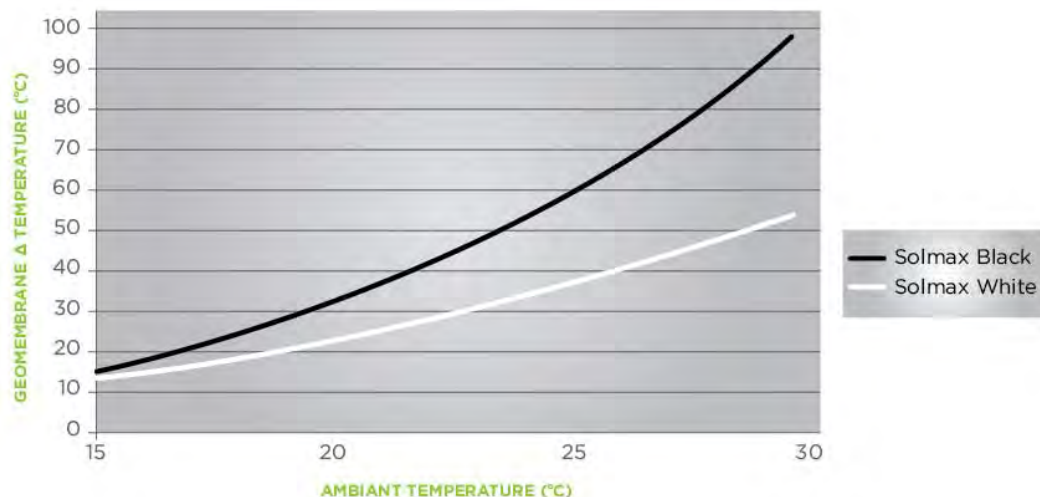

The chart above shows the data for Las Vegas, which is typical of desert-like conditions with high radiation levels. When exposed to the same ambient temperature, the white reflective prime finish helps keep the geomembrane's temperature as much as 40°C cooler, demonstrating the importance of sunlight reflection in contributing to the durability of geomembranes.

### Other advantages include:

- Wrinkle-free deployment
- Lower heat build-up → lower thermal elongation → longer daytime for welding
- Easier placement of cover layers
- When used in water reservoirs → lower temperature → less algae and microbiological organism growth risk
- Reduced evaporation.

As illustrated, users in regions with high UV radiation will benefit substantially from using geomembranes with white reflective finishes. The reduction in the geomembrane's temperature will lead to improvements in durability, weldability, quality control and imperviousness, extending the life of the overall system.

[Liner, UV radiation, geomembrane, temperature effects, white, reflective](#)



## CONTACT SOLMAX

Subject \* ▼

First Name \* Last Name \*

Company Name \* Location

Email \* Phone \*

Industries \* ▼ Profession \* ▼

Message \*



ATTACH A FILE 

I agree to the [privacy policy agreement](#).

SEND



# **ATTACHMENT 10**

***White-Surfaced HDPE Geomembranes: Assessing Their Significance to Liner Design and Installation***

**M. Cadwallader**  
Gundle Lining Systems Inc., USA

**M. Cranston**  
Chemical Waste Management, USA

**I.D. Peggs**  
I-Corp International Inc., USA

**ABSTRACT**

A significant temperature reduction under typical weather conditions was found to occur for a white-surfaced HDPE geomembrane compared to a standard black-surfaced geomembrane. Under clear skies at an ambient air temperature of approximately 30°C, geomembrane temperature was reduced as much as 24°C compared with black sheet. Effects of temperature reduction in terms of expansion/contraction of geomembranes, subgrade soil desiccation, and long term aging are reviewed and discussed. Identical installation damage in both white-surfaced and black geomembrane was observed and photographed in order to assess relative inspection visibility.

**INTRODUCTION**

White-surfaced geomembranes have been used over the last few years in a number of different applications. Because of the two-color scheme, these materials have become attractive to geotechnical and geosynthetic engineers for the ease of detecting damage during installation, as well as for subgrade desiccation protection and wrinkle reduction due to reduced geomembrane temperatures resulting from the light colored surface. With their increasing application in the liner industry has come a need to clearly and scientifically document their performance and behavior.

**SOLAR ENERGY ABSORPTION STUDY**

The degree of solar thermal energy absorption is one distinct difference between standard black geomembranes and white-surfaced geomembranes, a white surface being more reflective than a black surface. In order to measure the degree of solar thermal energy absorption, temperature sensors were embedded in black geomembrane and in white-surfaced geomembrane. Textured black geomembrane was also compared with smooth black geomembrane in this thermal energy absorption study.

Specimens and Instrumentation Each specimen was cut about 60 cm (2 ft) or 30 cm (1 ft) square. Uninsulated Type K (chromel/alumel) thermocouples manufactured from 25  $\mu\text{m}$  (1 mil) diameter wire were attached to top and bottom surfaces of each specimen. The beads on the thermocouples were approximately 3  $\mu\text{m}$  diameter and, are, therefore, capable of measuring the true temperature of the surface layer without significantly affecting the surface temperature. Conventional surface-contact thermocouple probes would affect the temperature being measured and could not respond quickly to changes in surface temperature.

Prior to assembly, all the thermocouples were placed in iced water for calibration. They all read to within 0.5°C of one another.

Each thermocouple bead was fixed in place by heating it, and the adjacent geomembrane surface, with the 1 mm diameter spherical tip of a pointed soldering iron. A very light pressure and quick contact were made to ensure that the thermocouple bead was not buried in the geomembrane, but remained in the surface layer. On the textured geomembrane, the thermocouple bead was placed on a raised part of the surface. The final assembly was very delicate and needed extremely careful handling to prevent the thermocouples from breaking. The specimens were placed on a 50 mm thick layer of sand and exposed to sunlight. The edges of the specimens were weighted to prevent convection of air between the specimen and the sand. The temperature of the sand under one specimen was also measured.

Results An abbreviated summary of measured reference and geomembrane temperatures under a clear sky follows. Two specimens of different degrees of "whiteness" were tested:

Equilibrium Conditions (°C)

Air	32.0	33.0	32.6	32.0	30.3	30.6	32.0
Sand	34.2	34.8	35.7	36.2	32.6	36.0	38.0
Black smooth, top	65.4	68.0	66.6	67.7	57.8	64.6	67.0
Black textured, top	62.4	65.6	64.2	66.4	55.1	60.6	61.8
White/grey smooth, top	48.1	48.7	48.9	49.7	42.6	47.1	50.0
White smooth, top	43.4	43.3	44.3	44.0	39.4	41.8	43.8

The bottom surface temperatures were consistently about 2°C lower than the top surface temperatures.

In summary, at an ambient temperature of approximately 30°C, the geomembrane temperatures were as follows:

Smooth black geomembrane, top	67°C	
Textured black geomembrane, top	64°C	(-3°C)
White/grey geomembrane, top	49°C	(-18°C)
White geomembrane, top	43°C	(-24°C)

The black textured geomembrane had a surface temperature that was lower than the smooth black geomembrane surface temperature, by about 3°C. This lends credence to the many comments from field installation

crews and CQA monitors that textured HDPE geomembrane is cooler than smooth geomembrane and does not wrinkle as much.

Depending on the degree of "whiteness", the non-black smooth geomembrane surface temperatures were up to 24°C (43°F) lower than smooth black geomembrane surface temperatures.

Temperature differences due to varying degrees of solar thermal absorption have a number of significant, geotechnical benefits and geosynthetic durability consequences as discussed below.

#### **GEOMEMBRANE EXPANSION/CONTRACTION CONSIDERATIONS**

In northern desert environments, where black geomembrane temperatures can be near 80°C (170°F) in the summer and -30°C (-22°F) in the winter, there can obviously be a change in geomembrane temperature of 100°C (180°F) or more. In more temperate climates, the change can easily be 50 to 75°C (90-135°F). White-surfaced geomembrane will reduce these temperature swings by 25 to 50%.

Thermal expansion/contraction makes it necessary to consider the amount of waviness (compensation) that must be built into, or kept out of, geomembrane liners when they are installed. This is necessary to prevent excessive contraction stresses at low temperatures, and to prevent excessive wrinkling when a soil cover has to be placed on the liner at a higher temperature than at installation. Temperature reduction through reflection of solar energy can result in easier more effective geomembrane installation, with a final seamed geomembrane less prone to expansion/contraction stresses, and, therefore, less prone to potential failures due to stress cracking.

Using the temperatures obtained in the above study and a low temperature of -18°C (0°F), the calculated contraction of a white-surfaced geomembrane will be 39% less than the contraction of a black geomembrane.

#### **GEOMEMBRANE AGING PHENOMENA**

Advantages of maintaining a lower geomembrane temperature are also evident in long term aging tests. Exposing any material to a high temperature is one of the most effective ways of promoting general degradation.

Increasing temperature accelerates both stress crack phenomena and oxidative degradation. Chan and Williams (1983) have indicated that stress crack growth rates in HDPE increase 40% for every degree (Celsius) rise in temperature. Klemchuck and Horng (1985) have found measurable rates of oxidation at only 40°C (72°F). Thermal stresses in geomembranes have been surveyed and oxidative degradation measured by Cadwallader and Metzger (1987), revealing considerably shortened oxidative stability in polyethylene with increasing temperature. In consideration of improved long term aging, Halse et al (1990) surveyed various methods of geomembrane temperature reduction under solar

exposure including soil covers, geotextile covers, and white painted surfaces.

The HDPE gas pipe industry presently uses a lifetime prediction technique based on the stress rupture performance. The prediction method, ISO TC 138/WG5, involves measuring the stress rupture performance of the pipe material at two elevated temperatures and then projecting such curves to 20°C. Figure 1 is a family of such curves for polyethylene pipe. The projected 20°C regression line is based on the Rate Process Method (RPM) mathematical model introduced by Bragaw, (1980):

$$\log t = A + B/T + C \log p \quad (1)$$

where t = time to failure  
p = applied stress  
T = temperature  
A, B, and C are constants

The RPM incorporates three variables (time, temperature, and stress) into a mathematical model that describes the stress rupture curves. With stress rupture data obtained at three elevated temperatures, the three unknown constants, A, B, and C, can be determined. Subsequently, the complete stress rupture curve at 20°C can be plotted, with the exception that the actual transition time and stress are not accurately known.

The experimental technique used to generate stress rupture curves in pipes has been extended to geomembranes. A procedure described in the Geosynthetic Research Institute standard GRI.GM5 (1992) uses a single face notched specimen in a constant tensile load test to determine the stress rupture behavior of geomembranes and seams in geomembranes. These tests are presently done at elevated temperatures but in a surface-active agent used to promote stress cracking which makes actual field lifetime predictions impossible to make. However, Kanninen et al (1993) (this conference) have reported initial work using fracture mechanics theory coupled with time/temperature shifting methods (developed in pipe studies) that should enable geomembrane lifetime predictions to be made after crack growth testing at only one elevated temperature.

It is illuminating to note in Figure 1 that under a sustained stress of 2400 kPa (350 psi) at 40°C, the polyethylene pipe lasts fifty years. If the temperature is increased to 60°C, the lifetime is reduced to 30,000 hours or 3.4 years. As seen previously, when an exposed black geomembrane is 60°C, a white-surfaced geomembrane will only be 40°C.

The temperatures of exposed liners can be very high due to absorption of solar energy. Temperatures of 80°C (170°F) have been noted for black synthetic liners. It follows, therefore, that surface temperature moderation will promote lengthened lifetimes of exposed stressed geomembranes.

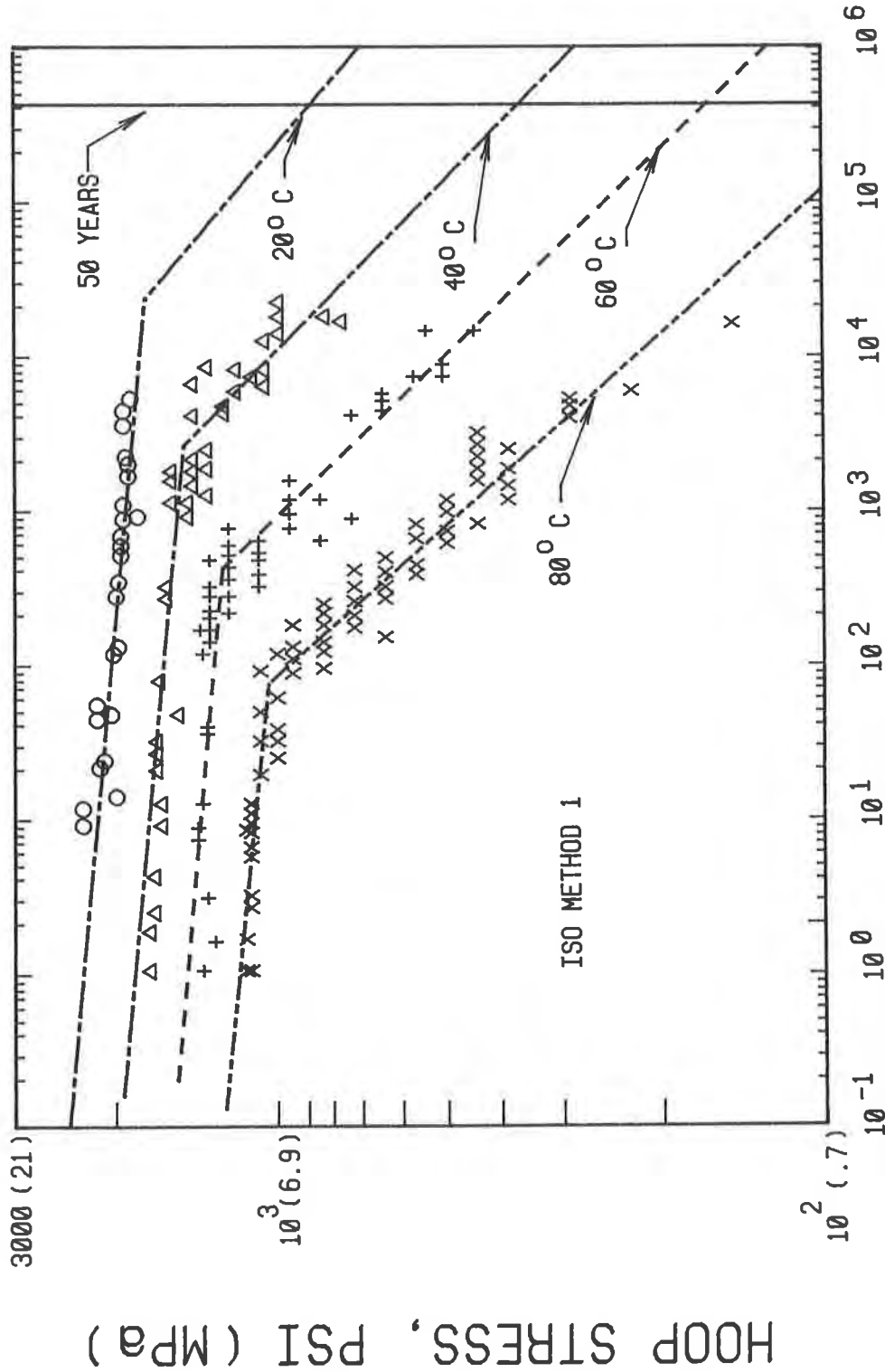

TIME, HOURS  
PE PIPE STRESS RUPTURE CURVES

FIGURE 1



FEB - 84



It should be noted that carbon black (used in black geomembranes) is still regarded as the best ultraviolet (UV) radiation stabilizer, with a long history of experience under solar exposure. Hindered amine light stabilizers (HALS) for nonblack applications are also proving to be excellent UV stabilizers for polyolefins, though perhaps not quite as effective as carbon black. The pertinent consideration for aging of geomembranes under sunlight is thus a comparison of the effectiveness of UV protection by carbon black or HALS, and the reduction in geomembrane temperature generated by switching from carbon black to HALS in a reflective surface. The answer varies depending on incident amounts of ultraviolet light and solar thermal energy, and on quality of UV stabilization. A white surface reflects incident UV as well as heat, therefore necessitating less UV stabilization. With good UV stabilization, temperature (especially in conjunction with contraction stresses) becomes the life-determining variable for most exposed geomembrane applications.

### **SUBGRADE DESICCATION**

Geomembranes which reflect heat and maintain a lower surface temperature should retard subgrade desiccation.

Basnett & Brungard (1992) have reported severe desiccation of a clay subgrade under a geomembrane-lined landfill slope. Clay along the cell bottom was found to be adequately moist while clay on the side slopes was heavily desiccated with cracks averaging 10 to 25 mm (.5-1 in.) wide and extending the full depth of the clay layer, i.e., 30 cm (1 ft.). Figure 2 shows subgrade desiccation under the geomembrane.

Because the desiccation extended at least 30-50m (100-165 ft.) back from the edge of the HDPE geomembrane cover, contact with air is assumed not to be necessary in order to effect subgrade desiccation. The following mechanism of desiccation under the geomembrane was therefore proposed. It was reported that liquid pooling under the liner at the toe of the landfill slopes had been observed. Daily summertime surface temperatures of 66°C (150°F) or greater caused the geomembrane to wrinkle and, therefore, to form air pockets between the HDPE and subgrade clay surface. The hot air in the pocket would, therefore, become humid due to moisture leaving the clay under the temperature gradient. When the liner cooled at night, the relative humidity of the trapped air would increase to 100%, condensation would form on the underside of the geomembrane and surface of the clay, and drain downslope to the toe. Further heating and cooling cycles would cause desiccation of the clay from the top of the slope to the bottom of the slope. This proposed mechanism can be expected to occur whenever there are above freezing temperature variations, and the geomembrane has not been pressed into intimate contact with the subgrade clay.

Basnet and Brungard's hypothesis fits data reported by Corser and Cranston (1991) and by Corser, et al (1992). These engineers studied subgrade desiccation under typical liner and cover sections and

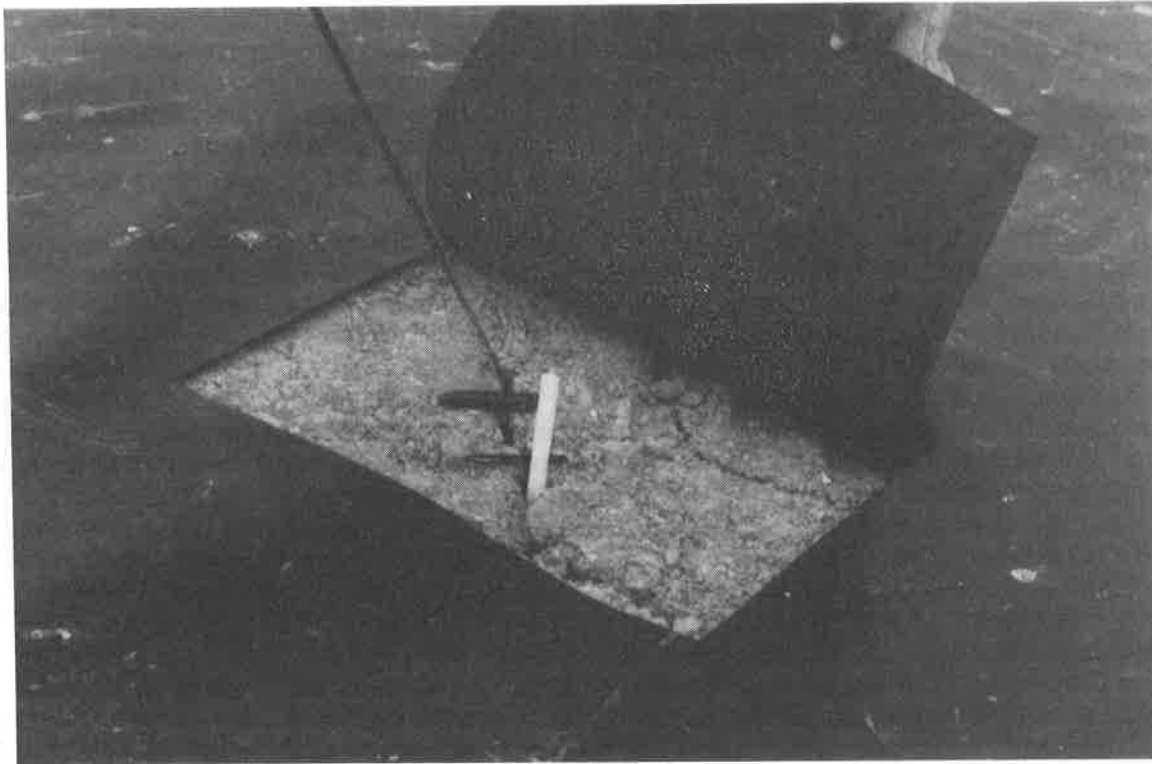

Figure 2. Subgrade Desiccation Under Exposed Geomembrane.  
Note Condensation On Underside of Membrane (Courtesy of CH2M Hill)

tracked the relationship between the amount of soil desiccation and the soil temperatures and tensions.

#### **CALIFORNIA CLAY DESICCATION STUDY**

To investigate the moisture-loss/clay desiccation mechanism, a test fill pad was constructed for the Corser and Cranston study with three feet of compacted clay and included a lower portion with a two percent slope and an upper portion with a slope of 3H:1V. The test fill was subdivided into three sections consisting of: 1) 0.5m (1.5 ft) of vegetative soil cover, 2) 1.5 mm (60 mil) HDPE, and 3) 1.5 mm (60 mil) HDPE with 0.6 m (2 ft) of vegetative soil cover. Instruments installed in the test fill include the following:

- Thermistors - to measure soil temperature fluctuations
- Tensiometers - to measure relative soil suctions

The instruments were installed at various depths throughout the day and vegetative soil cover components of the composite liner/cover systems in both the floor and slope portions of each of the three test sections. Double-ring infiltrometer tests were conducted on two of the test sections to confirm that minimum clay field permeabilities were achieved.

The test fill was constructed in April 1990 at the Chemical Waste Management, Inc. (CWM), Kettleman Hills Facility in Kettleman City, California. The clay material was obtained from a local borrow source and consisted of a high plasticity clay. The instruments were monitored by CWM on a daily basis initially and since on a weekly basis with regular periods of daily monitoring.

In October 1990, May 1991, and December 1992, site inspections of the clay test fill were conducted. In each of the three test sections, one excavation was made on the floor and one on the slope. The materials overlying the clay were removed exposing approximately .5 m x 1.5 m (5 ft x 5 ft) test sections, sketches and photographs taken of the exposed areas and test pits dug for the collection of moisture content samples and pocket penetrometer readings. The field data collected during each inspection was used for correlation with the instrumentation field data collected by CWM.

Desiccation was observed through monitoring the tensiometer probes and confirmed via periodic inspection and laboratory soil moisture content determinations. Tensiometers measure soil suction pressure which decreases as the soils dry out.

Based upon the monitoring and testing conducted in this study, it can be concluded that compacted cover/liner systems can lose moisture content, and desiccation cracks may form even after limited exposure to arid climates.

The moisture loss is suspected to be a result of moisture evaporation caused by hot surface temperatures. In the case of the liner section with only the HDPE over the compacted clay, the moisture is suspected to have collected in air pockets in the areas where the HDPE was not in contact with clay, then either passing through the HDPE as a vapor or running down to lower areas where the HDPE remains in contact with the clay. Soil suction profiles indicated increased soil tension both in the tensiometers near the surface and near the bottom of the clay in the section. Temperature profiles for this section indicated the clay surface undergoes large temperature fluctuations and soil temperatures could be significantly higher than the air temperatures, as much as 11°C (20°F). Surface temperatures in the clay were as high as 46°C (115°F) while air temperatures were approximately 35°C (95°F).

The cover section with only vegetative soil cover over the compacted clay did not perform well during the summer months. Increased soil suctions recorded by the tensiometers near the surface of the clay have indicated drying of the clay. Erratic readings of the vegetative soil cover tensiometers appear to confirm this clay surface moisture loss. Moisture leaving the clay material and passing through the vegetative cover results in drops in the tensiometer readings as the moisture passes by the tensiometer tips and then returns as drier conditions are re-established.

The test section with the best test performance was the section with both an HDPE cover and a vegetative soil cover. The vegetative

soil cover not only acted to insulate the clay from major daily temperature fluctuations but also weighted down the HDPE cover to maintain direct contact with the clay, thereby eliminating air pockets where drying occurs. In addition, the HDPE cover acts as a vapor barrier to reduce the moisture loss migration from the clay component. This section exhibited fairly consistent readings indicating very little change in moisture content both at the top and bottom of the clay layer.

During the visual site inspections, it was determined the cover section with the HDPE cover and vegetative soil cover exhibited the best performance. Only minor hairline cracks were noted in the surface of the clay. The section with the vegetative soil cover over the compacted clay exhibited extensive cracking. In October 1990, the crack widths varied from 25-100 mm (0.1-0.4 in) and depths varied between 25-100 mm (1-4 in). In May 1991, crack depths and widths had not significantly changed, however, by December 1992, the cracking had increased to widths of nearly 25 mm (1 in) and depths over .3 m (1 ft).

The section with an HDPE liner over the compacted clay simulates a typical landfill liner system. Depending on the construction phasing and the rate of fill placement, portions of landfill liner systems could be exposed to direct sunlight and weather conditions similar to this test section. In areas where the HDPE liner remained in contact with the clay, the moisture content of the clay appeared to have increased and in areas where no contact occurred, the clay had dried and cracked. Observed cracks had widths up to 6 mm (0.25 in) and depths up to 76 mm (3 in) when observed in May 1991. With this information and other observations noted during landfill construction and post-construction observations, it may be surmised that this type of liner section, when exposed to arid weather conditions could dry out in some areas and the drying depth may be substantial.

#### Clay Subgrade Under White-Surfaced Sheet

In February, 1992, a white HDPE liner was installed over the top of the exposed black HDPE liner on the test pad. This material was placed to reflect sunlight and thereby reduce clay surface temperatures and daily temperature fluctuations. Tables 1 and 2 present a representative comparison of some of the thermistor and tensiometer data respectively collected in Section 1 where the HDPE liner was placed over the compacted clay without any vegetative soil cover. The temperature recorded by thermistors and the soil suction pressures recorded by the tensiometers, both set at various depths are shown for similar dates in 1990 before the placement of the white reflective HDPE liner and compared to 1992 dates after the white HDPE liner had been installed.

The preliminary data indicates the temperatures of the compacted clay have been reduced by an average of 7°C (12°F) at all depths in the clay. Temperature decreases of 8-11°C (15°-20°F) were not uncommon near the surface of the clay during the peak of the hot summer period and substantial decreases in daily temperature

CHEMICAL WASTE MANAGEMENT, INC.  
 KETTLEMAN HILLS FACILITY  
 CLAY TEST PAD THERMISTOR DATA

BLACK LINER										WHITE REFLECTIVE LINER						
DATE	TIME	AMB. AIR TEMP(° F)	THERMISTOR DEPTH AND TEMPERATURE (° F)					DATE	TIME	AMB. AIR TEMP(° F)	THERMISTOR DEPTH AND TEMPERATURE (° F)					
			3 in.	9 in.	15 in.	27 in.	27 in.				3 in.	9 in.	16 in.	27 in.		
10-Apr-90	16:15	86	64.4	64.4	66.2	68.0	18-Mar-92	11:41	62	58.1	57.9	57.6	55.8			
19-Jun-90	08:13	78	81.9	83.3	85.1	87.4	28-Jun-92	08:20	72	75.4	76.1	77.0	77.2			
28-Jun-90	08:15	75	85.5	87.1	89.4	92.1	2-Jul-92	07:40	78	75.0	75.6	76.1	76.1			
2-Jul-90	08:17	80	86.5	88.2	90.3	92.8	8-Jul-92	10:17	85	75.0	75.6	75.9	77.0			
10-Jul-90	09:20	87	87.6	89.2	91.0	94.1	15-Jul-92	14:05	100	76.1	76.6	77.5	79.7			
13-Jul-90	09:19	90	88.7	89.8	91.9	96.1	22-Jul-92	15:07	93	77.5	78.4	79.3	80.6			
20-Jul-90	13:45	95	91.2	92.8	95.0	97.9	29-Jul-92	15:28	106	76.6	78.6	78.4	82.9			
27-Jul-90	09:35	87	91.9	93.6	95.7	95.5	5-Aug-92	15:06	99	78.6	79.2	80.6	81.5			
6-Aug-90	09:40	90	93.0	94.3	95.9	97.3	12-Aug-92	16:01	105	79.9	80.6	81.7	84.9			
10-Aug-90	12:39	96	93.7	95.2	97.2	99.5	20-Aug-92	15:50	107	81.3	81.7	83.7	86.2			
20-Aug-90	11:15	83	92.8	93.2	93.2	90.5	28-Aug-92	15:10	100	80.6	81.7	81.1	81.7			
27-Aug-90	13:38	84	90.9	91.2	91.6	91.2	4-Sep-92	15:27	83	79.5	79.3	79.3	77.2			
7-Sep-90	13:45	94	90.9	91.2	91.9	92.3	11-Sep-92	15:36	91	78.1	78.4	78.4	78.3			
14-Sep-90	09:58	78	90.7	91.2	91.6	90.3	15-Sep-92	12:50	88	78.1	77.9	77.0	76.6			
17-Sep-90	09:07	90	90.1	90.3	90.5	88.3	23-Sep-92	11:29	89	77.9	78.1	78.4	78.4			
21-Sep-90	11:11	79	89.4	89.6	89.6	88.2	29-Sep-92	15:49	102	77.2	77.7	77.9	80.2			
24-Sep-90	09:30	72	88.7	88.5	88.2	84.7	5-Oct-92	14:36	89	76.5	75.6	75.9	75.7			
26-Sep-90	10:57	76	88.0	87.8	87.6	84.7	13-Oct-92	15:08	95	76.1	75.9	75.7	77.9			
1-Oct-90	09:19	98	87.3	87.1	87.3	86.5	19-Oct-92	09:26	74	75.0	71.4	73.8	72.9			
15-Oct-90	11:25	85	84.9	84.6	84.0	81.1	23-Oct-92	15:25	81	73.9	73.2	72.3	66.0			
18-Oct-90	14:28	92	89.4	89.4	89.4	88.3	5-Nov-92	15:00	76	70.9	69.8	68.5	68.2			
31-Oct-90	12:26	67	82.2	80.8	78.6	71.4	11-Nov-92	15:28	62	70.2	68.5	67.6	63.1			
10-Nov-90	13:15	62	76.4	76.0	74.9	70.2	16-Nov-92	14:29	74	67.6	66.0	63.7	62.4			

TABLE 1 - STATION 1A THERMISTOR DATA (Section 1 Floor Data)

CHEMICAL WASTE MANAGEMENT, INC.  
 KETTLEMAN HILLS FACILITY  
 CLAY TEST PAD TENSIOMETER DATA

BLACK LINER										WHITE REFLECTIVE LINER					
DATE	TIME	ATM PRESSURE	TENSIOMETER READINGS (Centibars)					DATE	TIME	ATM PRESSURE	TENSIOMETER READINGS (Centibars)				
			3 in.	9 in.	15 in.	27 in.	27 in.				3 in.	9 in.	15 in.	27 in.	
10-Apr-90	16:15	29.45	38	24	42	14	18-Mar-92	11:15	29.23	10	8	5	49		
19-Jun-90	08:13	29.30	4	12	33	7	28-Jun-92	08:10	29.15	10	8	12	28		
28-Jun-90	08:15	29.37	6	16	34	7	2-Jul-92	07:40	29.20	11	7	12	26		
2-Jul-90	08:17	29.22	6	20	34	6	8-Jul-92	10:14	29.28	11	5	6	22		
10-Jul-90	08:23	29.27	6	24	32	4	15-Jul-92	14:02	29.14	11	8	4	20		
13-Jul-90	09:19	29.29	10	26	30	4	22-Jul-92	14:55	29.12	10	8	6	20		
20-Jul-90	13:45	29.17	8	22	33	1	29-Jul-92	15:25	29.09	10	9	6	20		
27-Jul-90	09:35	29.25	6	28	38	4	5-Aug-92	15:04	29.11	12	9	6	17		
6-Aug-90	09:40	29.20	8	35	33	4	12-Aug-92	15:41	29.04	12	10	6	16		
10-Aug-90	12:35	29.20	25	37	39	4	20-Aug-92	15:45	29.07	12	8	7	16		
20-Aug-90	11:15	29.20	17	42	45	6	28-Aug-92	15:09	29.19	14	10	10	22		
27-Aug-90	11:20	29.40	14	48	48	11	4-Sep-92	15:30	29.24	12	12	12	26		
7-Sep-90	13:45	29.34	17	51	50	10	11-Sep-92	15:32	29.19	12	8	9	28		
14-Sep-90	09:55	29.30	7	56	58	19	15-Sep-92	12:46	29.08	12	8	10	28		
17-Sep-90	09:05	29.11	16	63	56	18	22-Sep-92	14:37	29.10	12	8	8	24		
21-Sep-90	11:09	29.17	2	67	66	22	25-Sep-92	15:10	29.10	10	9	12	28		
24-Sep-90	08:59	29.33	6	58	60	23	29-Sep-92	15:48	29.09	11	11	10	26		
26-Sep-90	10:56	29.33	17	68	62	22	5-Oct-92	14:36	29.19	10	8	11	30		
1-Oct-90	09:17	29.22	10	66	62	21	13-Oct-92	15:05	28.99	10	6	10	29		
15-Oct-90	11:23	29.21	12	68	64	26	19-Oct-92	09:38	29.30	9	8	16	38		
18-Oct-90	14:18	29.35	70	48	26	17	5-Nov-92	14:16	29.26	9	8	13	40		
31-Oct-90	12:18	29.42	34	44	32	23	10-Nov-92	15:18	29.39	9	9	18	44		
10-Nov-90	13:15	29.40	45	48	34	26	16-Nov-92	14:26	29.20	11	10	18	44		

TABLE 2 - STATION 1A TENSIOMETER DATA (Section 1 Floor Data)

fluctuations were recorded. Additionally, clay temperatures never exceeded the ambient air temperature after installation of the white HDPE liner.

The temperatures of the clay beneath the exposed white HDPE liner were even lower than the adjacent soil covered HDPE/clay composite test pad, by typically 1-2°C (2°-3°F). Desiccation cracks observed during the December 1992 inspection revealed only minor cracking had occurred. Typical cracks were 2.5 mm (0.1 in) in width and 25-38 mm (1-1.5 in) deep, indicating some healing of the previously existing cracks underneath the black HDPE had taken place.

The preliminary tensiometer data indicates an overall decrease in soil suction pressures in 1992 because moisture content of the clay had dried in the two year period since the placement of the clay. Soil suction pressures appear much more stable in 1992, after the installation of the white-surfaced HDPE liner, showing a decrease in the fluctuation of soil pressures throughout the recording period. Tensiometer data collected in 1991, before installation of the white HDPE liner, indicates a pattern of fluctuating soil suction pressures similar to the 1990 data and continuance of the overall decrease of moisture content in the clay.

Detailed evaluations of all the instrumentation test data and complete results of the December 1992 site inspection are forthcoming. Final results, observations, and recommendations will be presented in a later summary report.

#### **INSTALLATION CONSIDERATIONS**

Installation of white-surfaced polyethylene geomembranes is conducted in exactly the same way as for standard polyethylene liner installations, with the same heat seaming methods and quality control procedures. In addition to the benefits of reduced expansion/contraction due to lower temperatures, such materials enable engineers and inspectors to detect installation damage more easily. The white surface layer, when impacted by routinely used installation equipment, reveals slits, scratches, abrasion marks, and holes with much better contrast than standard all-black geomembranes. The damage becomes visible because the black underlayer is revealed against a white background.

Detection of leaks is, of course, an important part of standard quality control efforts during an installation. The present emphasis on the use of soil/synthetic composite liners, barrier layers, and leak detection systems has occurred because agencies and regulators realize that it is extremely difficult to install a perfectly leak-free geomembrane. Darilek, et al (1989) published electrical resistance leak location data indicating an average of 26 leaks per 10,000 m<sup>2</sup> of geomembrane (ten leaks per acre). Although most of these leaks were pinhole leaks in seams, 26% of the reported leaks were panel tears and other such damage made during installation. These results indicate that there is room yet for improved inspection methods for geomembrane installations.

To assess whether the white-surfaced geomembranes make such inspections easier and more effective, identical scratches, slits and abrasion marks were made in adjacent samples of white-surfaced geomembrane and standard black sheet.

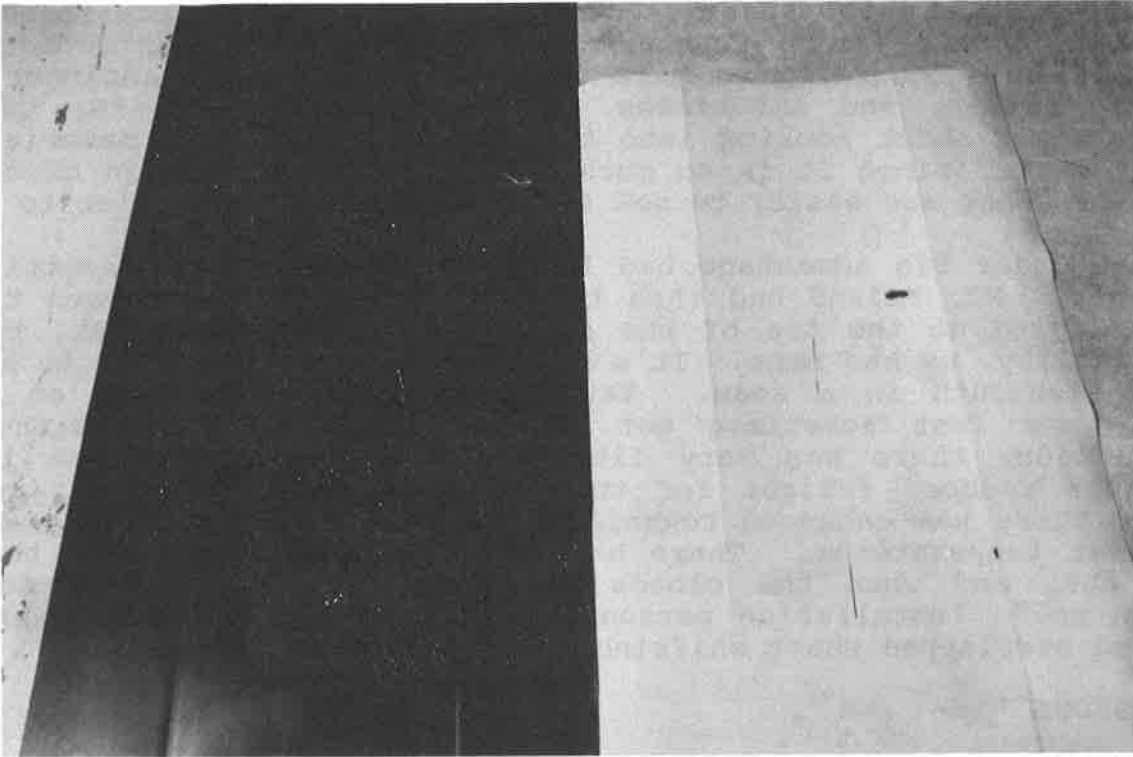

Figure 3. Visibility Comparison of Identical Damage  
In Standard Black and White-Surfaced HDPE

The white-surfaced geomembrane was 1.5 mm (60 mil) thick with a 0.125 mm (5 mil) coextruded white HDPE surface layer. Abrasion marks were made with a table saw blade elevated 0.375 mm (15 mils) from the tabletop. Punctures almost penetrating the geomembranes were made in each 1.5 mm sheet from the top surface down as well as from the bottom up. All types of damage were more visible in the case of the white-surfaced geomembrane. Figure 3 shows two of the samples in this installation damage comparison.

Discussions with project supervisors and quality assurance engineers verify the improvement of visual inspection for installation damage at white-surfaced geomembrane installations.

#### **WHITE-SURFACED HDPE LINER DURING LANDFILL INSTALLATION**

Envirite Corporation runs the Livingston Landfill in Livingston County, Illinois accepting metropolitan sanitary waste as well as nonhazardous waste. They constructed a double composite system consisting of 60 mil thick white-surfaced HDPE in combination with



three feet of clay, single-sided geotextile/geonet composite, and a secondary liner consisting of 60 mil white-surfaced HDPE and a single foot of recompacted clay. Conversations with the third party inspection engineer revealed that the white-surfaced sheet was much preferred over standard black sheet for various reasons.

One problem which had presented itself to third party inspectors was the uncertainty accompanying visual inspection of the geomembrane installation. According to Mike Friend, certification engineer with Vegrzyn, Sarver, and Associates of Pontiac, Illinois, "We usually inspect black sheet looking into the sun, but with this material, it doesn't matter since it is so much easier to see things in or on the sheet. Patches are easier to see and damage marks are easier to see."

The other big advantage had to do with temperature reduction in the liner. Mr. Friend had this to say: "It's very uncommon to not have bridging at the toe of the slopes on a site in August, but at this facility, we had none. It's also unusual in August not to have a single fishmouth in a seam. Yet we had none. Standing on black sheet, your feet sometimes get so hot they burn, but with this installation, there was very little heat radiation off the liner. There was reduced fatigue for the installation technicians, and we believe there was enhanced technician productivity and quality due to the lower temperatures. There have been less wrinkles when the sun comes out, and when the clouds block the sun, the sheet doesn't tighten up." Installation personnel did not have to worry about the deployed overlapped sheet shifting before it could be seamed.

#### CONCLUSIONS

Under solar exposure, white-surfaced geomembranes are cooler than black geomembranes. Lower temperatures provide several physical benefits such as lower expansion/contraction, greater resistance to long-term degradation, and increased protection of soil subgrades from desiccation. In addition, installation damage is usually more easily detected. Other aspects of installation and inspection appear to be made simpler as well.

#### REFERENCES

Basnett, C. and Brungard, M., (1992) "The Clay Desiccation of a Landfill Composite Lining System", Geotechnical Fabrics Report, January/February, pp. 38-41.

Bragaw, C. G., (1980) Proceedings of the Seventh Plastic Pipe Symposium, Vol. 20.

Cadwallader, M. W. and Metzger, P., (1987) "Accelerated Aging of High Density Polyethylene Geomembranes: A Novel Approach", 42nd Annual Purdue Industrial Waste Conference Proceedings.

Chan, M. K. V. and Williams, J. G., (1983) "Slow Stable Crack Growth in High Density Polyethylenes", Polymer, Vol. 24.

Corser, P., and Cranston, M., (1991) "Observations on Long-Term Performance of Composite Clay Liners and Covers", Proceedings of Geosynthetics Design and Performance Conference, Vancouver, British Columbia Geotechnical Society, May.

Corser, P., Pellicer, J., and Cranston, M., (1992) "Observations on Longterm Performance of Composite Clay Liners and Covers", Geotechnical Fabrics Report, November, pp 6-16.

Darilek, G. T., Laine, D. L., and Parra, J. O. (1989) "The Electrical Leak Location Method for Geomembrane Liners: Development and Applications", Geosynthetics '89 Conference Proceedings, Vol. 2, pp. 456-466.

GRI (1992) Test Method GM5, Geosynthetic Research Institute, Drexel University, Philadelphia, PA, April.

Halse, Y. H., Hullings, D. E., Koerner, R. M., and Lord, A. E., (1990) "Methods to Evaluate the Stress Crack Resistance of High Density Polyethylene FML Sheets and Seams", 16th Annual Research Symposium of the U. S. EPA, April.

Kanninen, M. F., Popelar, C. H., and Peggs, I. D. (1993). "A Methodology for Predicting the Lifetimes of HDPE Geomembranes", Proceedings of Geosynthetics '93. IFAI, St. Paul, MN.

Klemchuk, P. and Horng, P., (1985) "Longterm Aging Study of Antioxidants in Polyolefins", Plastics Compounding, Sept/Oct.



# **ATTACHMENT 11**



10875 Rancho Bernardo Road, Suite 200  
San Diego, CA 92127  
Phone: 858.716-2909  
Fax: 858.674.6586  
www.geosyntec.com

**ANNUAL INSPECTION REPORT  
ASH POND 2  
JOLIET 29 STATION  
18 JANUARY 2016**

Pursuant to 40 CFR 257.83(b), Geosyntec Consultants (Geosyntec) performed an annual inspection of Ash Pond 2 at the Joliet 29 Station in Joliet, Illinois (see Figure 1). The inspection included a review of available information regarding the status and condition of the CCR unit, a visual inspection of the CCR unit, including hydraulic and appurtenant structures, and preparation of this inspection report. The visual inspection was performed by Ms. Jane Soule, P.E., on 30 September 2015. A summary of the inspection findings is presented below and in Table 1.

**1. Changes in Geometry - §257.83(b)(2)(i)**

This is the initial annual inspection and, as such, there have not been previous annual inspections. Therefore, no changes in geometry from previous inspections could be assessed.

**2. Instrumentation – §257.83(b)(2)(ii)**

Geosyntec did not observe and is not aware of instrumentation associated with the hydraulic structures, impoundment embankments, or slope performance related to Ash Pond 2.

**3. Capacity and Impounded Volume – §257.83(b)(2)(iii) through (v)**

The capacity and impounded volume of Ash Pond 2 and estimated depth of impounded water and CCR are presented in Table 1. These volumes and depths were estimated using existing topographic maps and the observations made during the 30 September 2015 inspection.

Because this is the initial annual inspection, the maximum and minimum height of water and CCR in the unit since the last inspection could not be assessed.

**4. Structural/Operational Observations - §257.83(b)(2)(vi)**

Geosyntec did not identify site conditions that indicate an actual or potential structural weakness or have the potential to disrupt the operation and safety of the CCR units and appurtenant structures.

Ash Pond 2, Joliet 29 Station  
Initial Annual Inspection  
18 January 2016

5. Other Changes – §257.83(b)(2)(vii)

This is the initial annual inspection and there have not been previous annual inspections. Therefore, no changes affecting the operation or stability of the unit could be assessed.

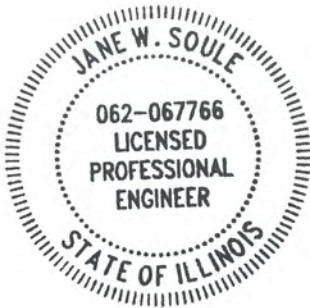

A handwritten signature in blue ink that reads "Jane W. Soule".

Jane W. Soule, P.E.

Illinois Professional Engineer No. 052-067766

Expiration Date: 11/30/2017

Ash Pond 2, Joliet 29 Station  
 Initial Annual Inspection  
 18 January 2016

**Table 1: Inspection Summary**

Category	Regulation Reference	Evaluation	Recommended Action
Changes In Geometry	§257.83(b)(2)(i)	Not Applicable <sup>(1)</sup>	None
Instrumentation	§257.83(b)(2)(ii)	None	None
Water Depth Estimate	§257.83(b)(2)(iii)	17 feet <sup>(2)</sup>	None
CCR Depth Estimate	§257.83(b)(2)(iii)	17 feet <sup>(3)</sup>	None
Estimated Storage Capacity <sup>(4)</sup>	§257.83(b)(2)(iv)	38.4 acre-feet 62,000 cy	None
Impounded Water Volume Estimate	§257.83(b)(2)(v)	27.3 acre-feet 44,000 cy	None
Impounded CCR Volume Estimate	§257.83(b)(2)(v)	9.3 acre-feet 15,000 cy	None
Structural/Operational Observations	§257.83(b)(2)(vi)	None Observed	None
Other Changes	§257.83(b)(2)(vii)	Not Applicable <sup>(1)</sup>	None

Notes:

1. This report documents the initial annual inspection.
2. This is the estimated maximum depth of water at the time of the inspection. The maximum and minimum depths since the last inspection are not applicable since this is the initial annual inspection.
3. This is the estimated maximum depth of CCR at the time of the inspection. The maximum and minimum depths since the last inspection are not applicable since this is the initial annual inspection.
4. Capacity was computed using computer-aided design computation methods based on 2007 topography by Natural Resource Technology within the pond footprint and a maximum pool elevation of 533.5 feet, based on the estimated lowest top of liner elevation. The storage capacity of the impoundment to a pool elevation corresponding to the top of the discharge weir at 532.85 feet is estimated to be 36.6 acre-feet (59,000 cubic yards [cy]).



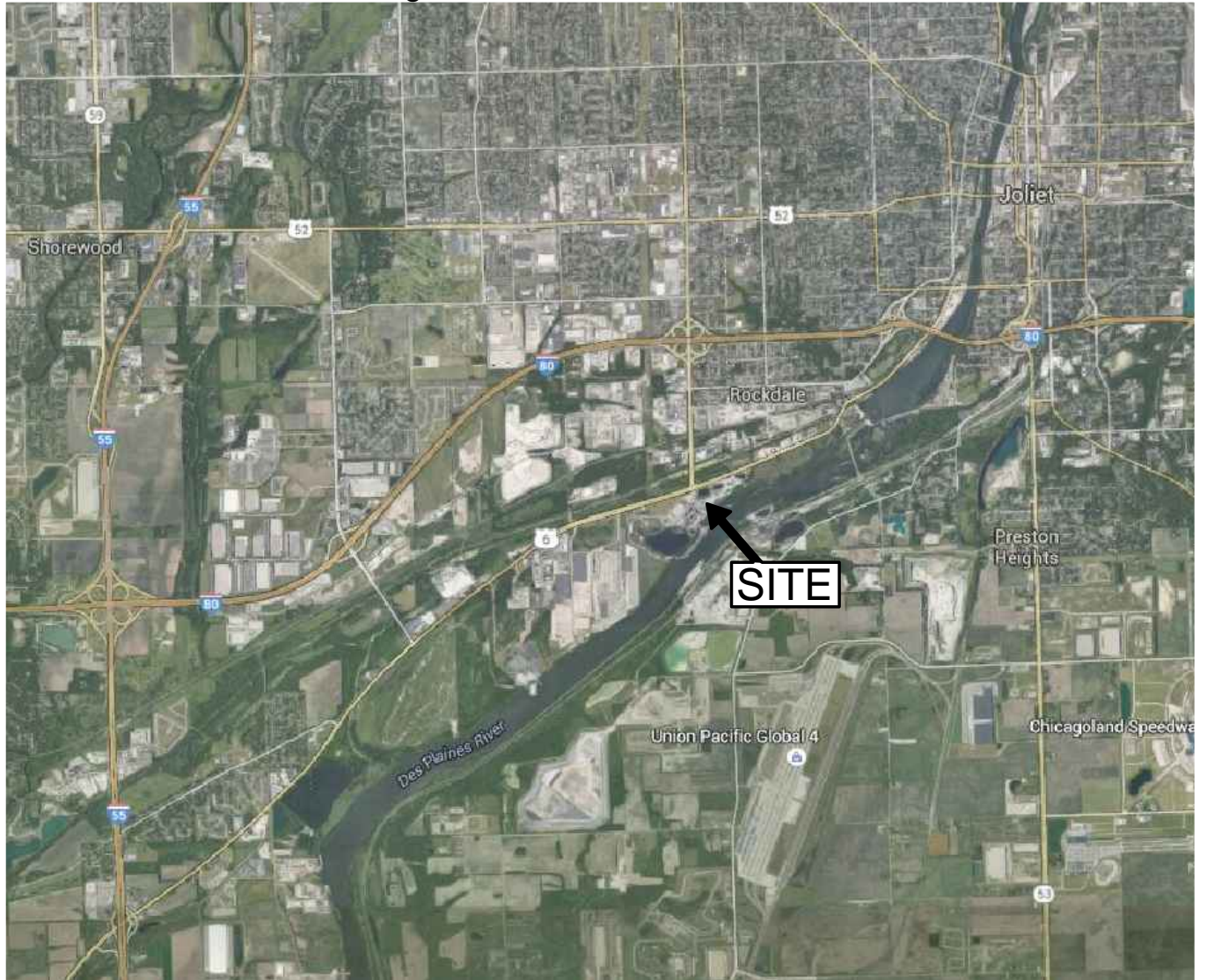

VICINITY MAP



SITE PLAN

ASH POND 2



NOT TO SCALE

VICINITY MAP AND SITE PLAN  
 JOLIET 29 STATION  
 JOLIET, ILLINOIS



DATE: JANUARY 2016

PROJECT NO. SW0251-06

FIGURE

1

REFERENCE: GOOGLE, 2016.





134 N. LaSalle Street, Suite 300  
Chicago, IL 60602  
Phone: 312-658-0500  
www.geosyntec.com

**ANNUAL INSPECTION REPORT  
ASH POND 2  
JOLIET 29 STATION  
16 OCTOBER 2017**

Pursuant to 40 CFR 257.83(b), Geosyntec Consultants (Geosyntec) performed an annual inspection of Ash Pond 2 at the Joliet Station in Joliet, Illinois (see Figure 1). The inspection included a review of available information regarding the status and condition of the CCR unit, a visual inspection of the CCR unit, including hydraulic and appurtenant structures, and preparation of this inspection report. The visual inspection was performed by Mr. Panos Andonyadis, P.E., on 5 September 2017. A summary of the inspection findings is presented below and in Table 1 following the text.

**1. Changes in Geometry - §257.83(b)(2)(i)**

During September 2016, a localized low-spot in the crest of the southeast embankment was raised approximately 1 foot to prevent overtopping during a 100-year storm event. Development of the plans and specifications were overseen by a licensed Professional Engineer.

**2. Instrumentation – §257.83(b)(2)(ii)**

Geosyntec did not observe and is not aware of instrumentation associated with the hydraulic structures, impoundment embankments, or slope performance related to Ash Pond 2.

**3. Capacity and Impounded Volume – §257.83(b)(2)(iii) through (v)**

The capacity and impounded volume of Ash Pond 2 and estimated depth of impounded water and CCR are presented in Table 1. These volumes and depths were estimated using existing topographic maps and observations made during the 5 September 2017 inspection. The present, maximum and minimum depth of water and CCR in the units are summarized in Table 1.

**4. Structural/Operational Observations - §257.83(b)(2)(vi)**

At the time of the inspection, the weep holes for the southern concrete retaining wall were observed to have accumulated minor amounts of sediment. The weep holes were cleared of sediment in early October 2017. No other features were observed that would be indicative of potential or actual structural weakness in Ash Pond 2. No conditions were observed that are currently, or have the potential to disrupt operation and safety of the impoundments and appurtenant structures.

Ash Pond 2, Joliet Station  
2017 Annual Inspection  
16 October 2017

5. Other Changes – §257.83(b)(2)(vii)

There were no other observed changes that could affect the operation or stability of the units.



*PAL* 10/16/2017  
Panos Andonyadis, P.E.  
Illinois Professional Engineer No. 062-066885

Expiration Date: 11/30/2017

Ash Pond 2, Joliet Station  
2017 Annual Inspection  
16 October 2017

**Table 1: Inspection Summary – Ash Pond 2**

Category	Regulation Reference	Inspection Report Section	Evaluation	Recommended Action
Changes in Geometry	§257.83(b)(2)(i)	4.1	Yes <sup>(1)</sup>	None
Instrumentation	§257.83(b)(2)(ii)	4.2	None	None
Water Depth Estimate <sup>(2)</sup>	§257.83(b)(2)(iii)	4.3	0 feet (min.) 0 to 17 feet (present) 17 feet (max) <sup>(2)</sup>	None
Water Elevation Estimate <sup>(2)</sup>	§257.83(b)(2)(iii)	4.3	+532.85 feet (min.) +532.85 feet (present) +532.85 feet (max)	None
CCR Depth Estimate <sup>(3)</sup>	§257.83(b)(2)(iii)	4.3	0 feet (min.) 0 to 17 feet (present) 17 feet (max) <sup>(3)</sup>	None
CCR Elevation Estimate <sup>(3)</sup>	§257.83(b)(2)(iii)	4.3	+516 feet (min.) +516 feet to +532.85 feet (present) +532.85 feet (max) <sup>(3)</sup>	None
Estimated Storage Capacity <sup>(4)</sup>	§257.83(b)(2)(iv)	4.3	38.4 acre-feet 62,000 cy	None
Impounded Water Volume Estimate	§257.83(b)(2)(v)	4.3	24.2 acre-feet 39,000 cy	None
Impounded CCR Volume Estimate	§257.83(b)(2)(v)	4.3	12.4 acre-feet 20,000 cy	None
Structural/Operational Observations	§257.83(b)(2)(vi)	4.4	None	None
Other Changes	§257.83(b)(2)(vii)	4.5	None	None

## Notes:

1. This report assesses changes in geometry since the initial annual inspection (2016). An isolated area in southeastern corner section of embankment was raised approximately 1 foot with 100 cubic yards of engineered fill material in September 2016.

Ash Pond 2, Joliet Station  
2017 Annual Inspection  
16 October 2017

2. This is the estimated minimum and maximum depth of water. The depth of water in the western portion of the pond is estimated to be 0 feet because CCR has mounded above the top of water. The depth of water in the eastern portion of the pond is estimated to be 17 feet because no significant CCR buildup by the outlet weir is assumed. The top of water is at the approximate elevation of the outlet weir, elevation +532.85 feet. No significant fluctuations in water level were noted in weekly inspection reports. The observed water level elevation of +532.85 feet is the same as the previous annual inspection.
3. This is the estimated minimum and maximum depth of CCR. The maximum depth of CCR is estimated to be 17 feet (elevation +532.85 feet) at the western portion of the pond and the minimum is 0 feet (elevation +516 feet) at the eastern portion of the pond, where is no significant CCR buildup by the outlet weir is assumed. No dredging was noted in weekly inspection reports since the last annual inspection. The observed maximum and minimum CCR levels are the same as the previous annual inspection.
4. Total capacity was computed using computer-aided design computation methods based on 2007 topography by Natural Resource Technology (NRT) within the impoundment footprint and a maximum pool elevation of +533.5 feet, based on the estimated lowest top of liner elevation. The storage capacity of the impoundment to a pool elevation corresponding to the top of the discharge weir at +532.85 feet is estimated to be 36.6 acre-feet (59,000 cy).



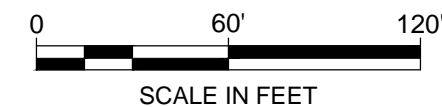
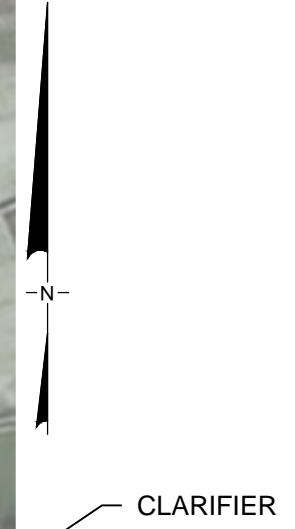

AERIAL IMAGE: GOOGLE EARTH  
CAPTURE DATE: APRIL 2017

SITE PLAN - ASH POND 2	
JOLIET 29 STATION JOLIET, ILLINOIS	
<b>Geosyntec</b> consultants	
PROJECT NO: CHE8348	October 2017
FIGURE <b>1</b>	

C:\USERS\RFISCHER\DESKTOP\SW0251\F01-20170928-BLANK



**ANNUAL INSPECTION REPORT  
ASH POND 2  
JOLIET STATION  
OCTOBER 2018**

This annual inspection report has been prepared pursuant to Title 40 of the Code of Federal Regulations (40 CFR) Part 257.83(b) for Ash Pond 2 at Joliet Station (Station) in Joliet, Illinois. The purpose of this project is to perform an annual inspection of Ash Pond 2 by a licensed professional engineer to ensure that the design, construction, operation, and maintenance of the coal combustion residuals (CCR) unit is consistent with recognized and generally accepted good engineering standards. Civil & Environmental Consultants, Inc. (CEC) completed the following scope of services in preparing this annual inspection report.

- CEC reviewed the weekly and monthly inspection reports provided by station personnel and the previous annual inspection report.
- CEC performed the annual inspection in accordance with the requirements of 40 CFR 257.83(b) including observations pertaining to the following:
  - Changes in Geometry - §257.83(b)(2)(i): Observations of changes in the geometry of Ash Pond 2 since the previous annual inspection.
  - Instrumentation - §257.83(b)(2)(ii): Inspection of the location and type of existing instrumentation and documentation of the maximum recorded readings of each instrument since the previous annual inspection from records provided by the Station.
  - Capacity and Impounded Volume - §257.83(b)(2)(iii) through (v): Inspection observations for the approximate minimum, maximum, and present depth and elevation of the impounded water and CCR; storage capacity of the impounding structure at the time of the inspection; and the approximate volume of the impounded water and CCR at the time of the inspection.
  - Structural/Operational Observations - §257.83(b)(2)(vi): Estimation of the approximate volume of the impounded water and CCR at the time of the inspection.
  - Other Changes - §257.83(b)(2)(vii): Inspection including change(s) which may have affected the stability or operation of the impounding structure since the previous annual inspection.

Ash Pond 2 is an inactive CCR surface impoundment that is scheduled for closure. CEC inspected Ash Pond 2 on October 5, 2018. Our observations showed no signs of distress that would suggest the stability or operation of the impounding structure is compromised.

**1.0 CHANGES IN GEOMETRY - §257.83(b)(2)(i)**

The Ash Pond 2 geometry was observed to be unchanged since the October 2017 inspection.

**2.0 INSTRUMENTATION - §257.83(b)(2)(ii)**

No instrumentation was reported or observed that would be associated with the hydraulic structures, impoundment embankments, and/or slope performance.

**3.0 CAPACITY AND IMPOUNDED VOLUME - §257.83(b)(2)(iii) through (v)**

Capacity and impounded volume of the Ash Pond 2 and estimated depth of impounded water and CCR are represented in Table 1, attached. Volumes and depths were determined by reviewing inspection reports, construction drawings, and from discussions with Station personnel.

**4.0 STRUCTURAL/OPERATIONAL OBSERVATIONS - §257.83(b)(2)(vi)**

Ash Pond 2 was inspected for signs of distress that would have the potential to disrupt operation and safety of the pond. Prior to the inspection, CEC reviewed the previous annual inspection report, which did not identify conditions that indicate an actual or potential structural weakness. Weekly and monthly inspection reports were also reviewed and did not indicate an actual or potential structural weakness.

**5.0 OTHER CHANGES - §257.83(b)(2)(vii)**

Ash Pond 2 was inspected for signs of other changes or distresses that would have the potential to disrupt operation and safety of the basins. Our inspection showed no distresses that would affect the operation and/or stability.

**6.0 LIMITATIONS AND CERTIFICATION**

This Annual Inspection Report was prepared to meet the requirements of §257.83(b) and was prepared under the direction of Mr. M. Dean Jones, P.E.

By affixing my seal to this, I do hereby certify to the best of my knowledge, information, and belief that the information contained in this report is true and correct. I further certify I am licensed to practice in the State of Illinois and that it is within my professional expertise to verify the correctness of the information. I am aware that there are significant penalties for submitting false information, including the possibility of fines and imprisonment.

Seal:



Signature: Maurice Dean Jones, Jr.

Name: M. Dean Jones, P.E.

Date of Certification: October 16, 2018

Illinois Professional Engineer No.: 062-051317

Expiration Date: November 30, 2019



Table 1: Inspection Summary - Ash Pond 2

Category	Regulation Reference	Evaluation	Recommended Action
Change in Geometry	§257.83(b)(2)(i)	None	None
Instrumentation	§257.83(b)(2)(ii)	None	None
Water Depth	§257.83(b)(2)(iii)	0 to 17 feet	None
CCR Depth	§257.83(b)(2)(iii)	0 to 17 feet	None
Estimated Storage Capacity	§257.83(b)(2)(iv)	38.4 Acre Feet	None
Impounded Water Volume	§257.83(b)(2)(v)	10.5 Acre Feet	None
Impounded CCR Volume <sup>1</sup>	§257.83(b)(2)(v)	27.9 Acre Feet	None
Structural/Operational Observations	§257.83(b)(2)(vi)	None	None
Other Changes	§257.83(b)(2)(vii)	None	None

1. Estimated impounded volume of CCR was provided by Station.

**ANNUAL INSPECTION REPORT  
ASH POND 2  
JOLIET STATION  
OCTOBER 2019**

This annual inspection report has been prepared pursuant to Title 40 of the Code of Federal Regulations (40 CFR) Part 257.83(b) for Ash Pond 2 at Joliet Station (Station) in Joliet, Illinois. The purpose of this project is to perform an annual inspection of Ash Pond 2 by a licensed professional engineer to ensure that the design, construction, operation, and maintenance of the coal combustion residuals (CCR) unit is consistent with recognized and generally accepted good engineering standards. Civil & Environmental Consultants, Inc. (CEC) completed the following scope of services in preparing this annual inspection report.

- CEC reviewed the weekly and monthly inspection reports provided by station personnel and the previous annual inspection report.
- CEC performed the annual inspection in accordance with the requirements of 40 CFR 257.83(b) including observations pertaining to the following:
  - Changes in Geometry - §257.83(b)(2)(i): Observations of changes in the geometry of Ash Pond 2 since the previous annual inspection.
  - Instrumentation - §257.83(b)(2)(ii): Inspection of the location and type of existing instrumentation and documentation of the maximum recorded readings of each instrument since the previous annual inspection from records provided by the Station.
  - Capacity and Impounded Volume - §257.83(b)(2)(iii) through (v): Inspection observations for the approximate minimum, maximum, and present depth and elevation of the impounded water and CCR; storage capacity of the impounding structure at the time of the inspection; and the approximate volume of the impounded water and CCR at the time of the inspection.
  - Structural/Operational Observations - §257.83(b)(2)(vi): Estimation of the approximate volume of the impounded water and CCR at the time of the inspection.
  - Other Changes - §257.83(b)(2)(vii): Inspection including change(s) which may have affected the stability or operation of the impounding structure since the previous annual inspection.

Ash Pond 2 is a CCR surface impoundment that is being cleaned of ash. CEC inspected Ash Pond 2 on October 7, 2019. At the time of our inspection, ash removal activities were underway with the goal of cleaning Ash Pond 2 so that it could be used as a low volume waste basin. At the time

of CEC's inspection, the cleaning project was not complete but most of the CCR had been removed leaving a layer covering the floor of the ash pond and a thin discontinuous layer of CCR adhering to the sides of the pond. The pond cleaning contractor was planning to continue excavating CCR followed by cleaning the membrane liner.

CEC inspected the ash pond and found no signs of distress that would suggest the stability or operation of the impounding structure is compromised.

#### **1.0 CHANGES IN GEOMETRY - §257.83(B)(2)(I)**

The Ash Pond 2 geometry was observed to be unchanged since the October 2018 inspection.

#### **2.0 INSTRUMENTATION - §257.83(B)(2)(II)**

No instrumentation was reported or observed that would be associated with the hydraulic structures, impoundment embankments, and/or slope performance.

#### **3.0 CAPACITY AND IMPOUNDED VOLUME - §257.83(B)(2)(III) THROUGH (V)**

Capacity and impounded volume of the Ash Pond 2 and estimated depth of impounded water and CCR are represented in Table 1, attached. Volumes and depths were determined by reviewing inspection reports, construction drawings, and from discussions with Station personnel.

#### **4.0 STRUCTURAL/OPERATIONAL OBSERVATIONS - §257.83(B)(2)(VI)**

Ash Pond 2 was inspected for signs of distress that would have the potential to disrupt operation and safety of the pond. None were observed. Prior to the inspection, CEC reviewed the previous annual inspection report. This report did not identify conditions that indicate an actual or potential structural weakness. Weekly and monthly inspection reports were also reviewed and did not indicate an actual or potential structural weakness.

#### **5.0 OTHER CHANGES - §257.83(B)(2)(VII)**

Ash Pond 2 will be cleaned of ash and used as a low volume waste basin. The pond was inspected for signs of other changes or distresses that would have the potential to disrupt operation and safety of the basins. Our inspection showed no distresses that would affect the operation and/or stability of Ash Pond 2.



**Table 1: Inspection Summary - Ash Pond 2**

<b>Category</b>	<b>Regulation Reference</b>	<b>Evaluation</b>	<b>Recommended Action</b>
<b>Change in Geometry</b>	§257.83(b)(2)(i)	None	None
<b>Instrumentation</b>	§257.83(b)(2)(ii)	None	None
<b>Water Depth</b>	§257.83(b)(2)(iii)	0 to 17 feet	None
<b>CCR Depth</b>	§257.83(b)(2)(iii)	0 feet	None
<b>Estimated Storage Capacity</b>	§257.83(b)(2)(iv)	38.4 Acre Feet	None
<b>Impounded Water Volume</b>	§257.83(b)(2)(v)	0 Acre Feet	None
<b>Impounded CCR Volume<sup>1</sup></b>	§257.83(b)(2)(v)	0 Acre Feet	None
<b>Structural/Operational Observations</b>	§257.83(b)(2)(vi)	None	None
<b>Other Changes</b>	§257.83(b)(2)(vii)	None	None

# **ATTACHMENT 12**

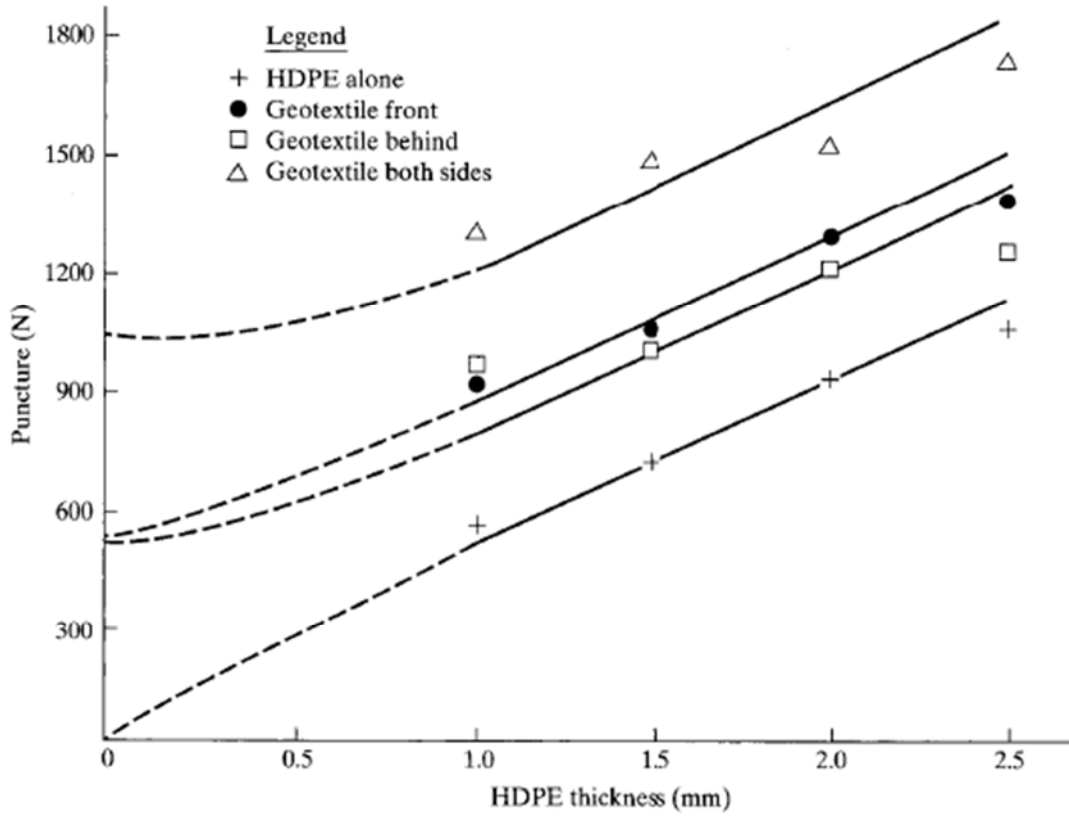

**Figure 5.8** Beveled flat-tip puncture test results on varying thicknesses of HDPE geomembranes and different combinations of geomembranes with 400 g/m<sup>2</sup> nonwoven needle-punched geotextiles. (After Koerner et al. [14])

Figure Obtained from *Designing with Geosynthetics*, 5<sup>th</sup> Ed., by Robert M. Koerner (2005).